

ESSEKASKA

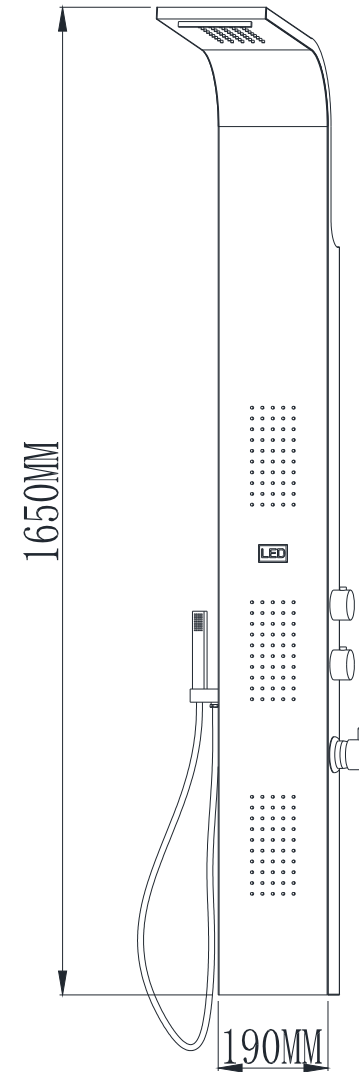

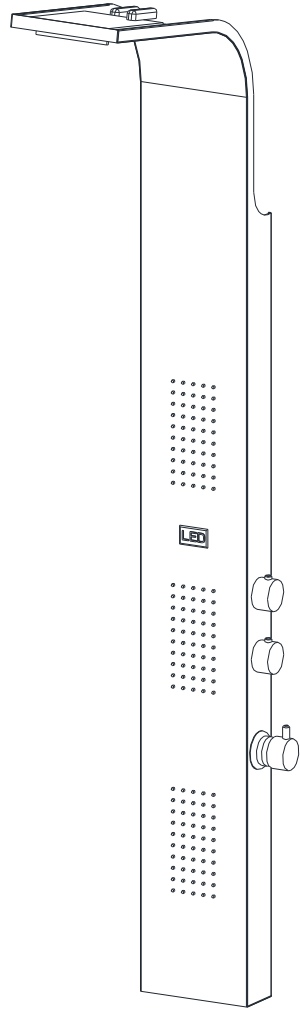

A

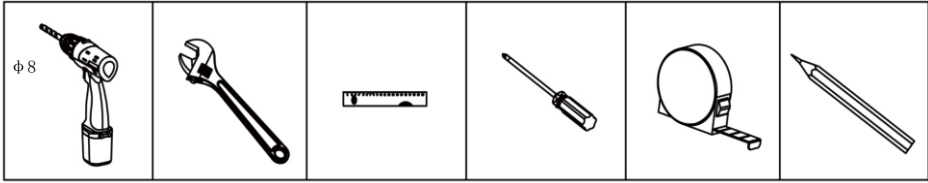
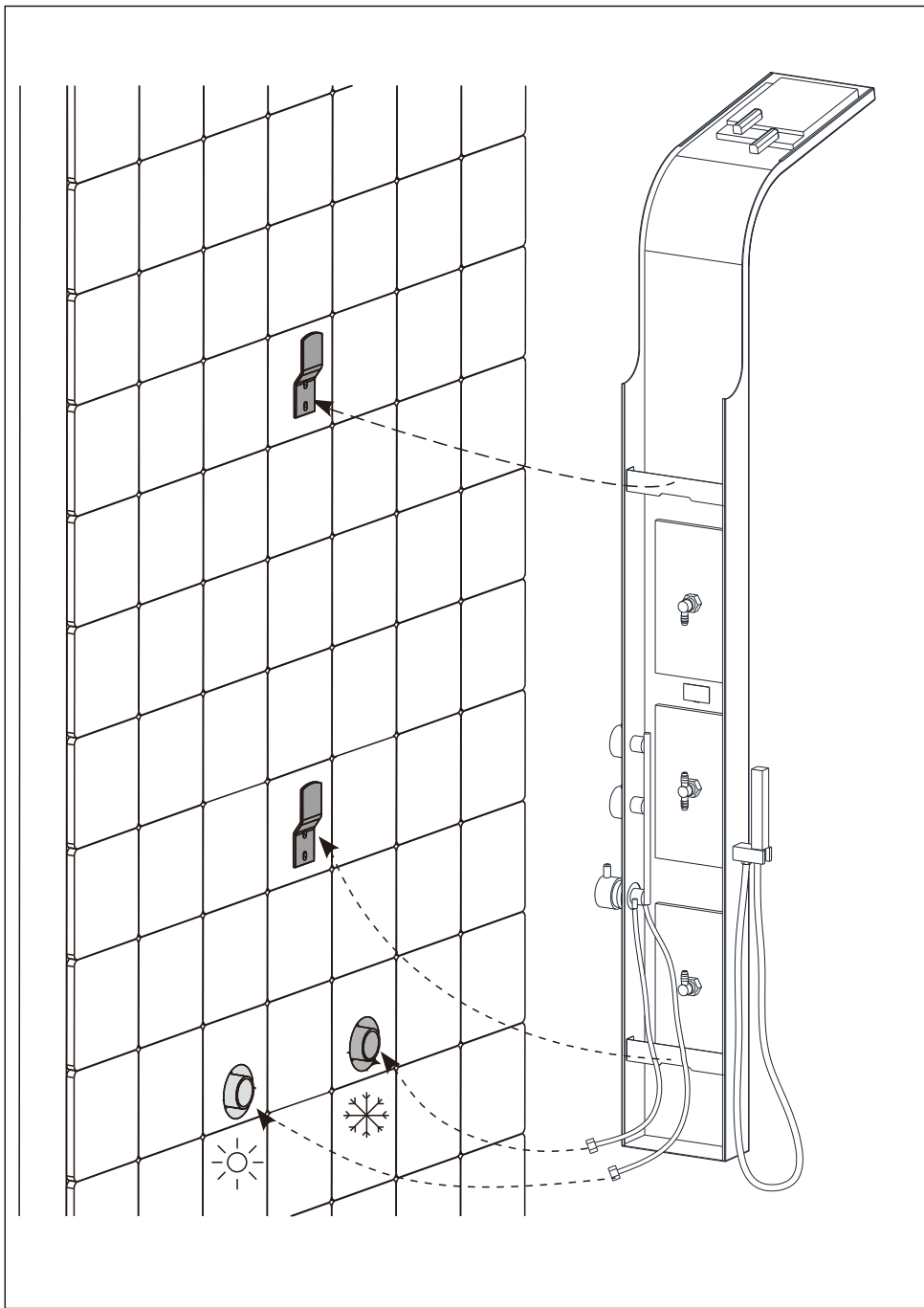

5

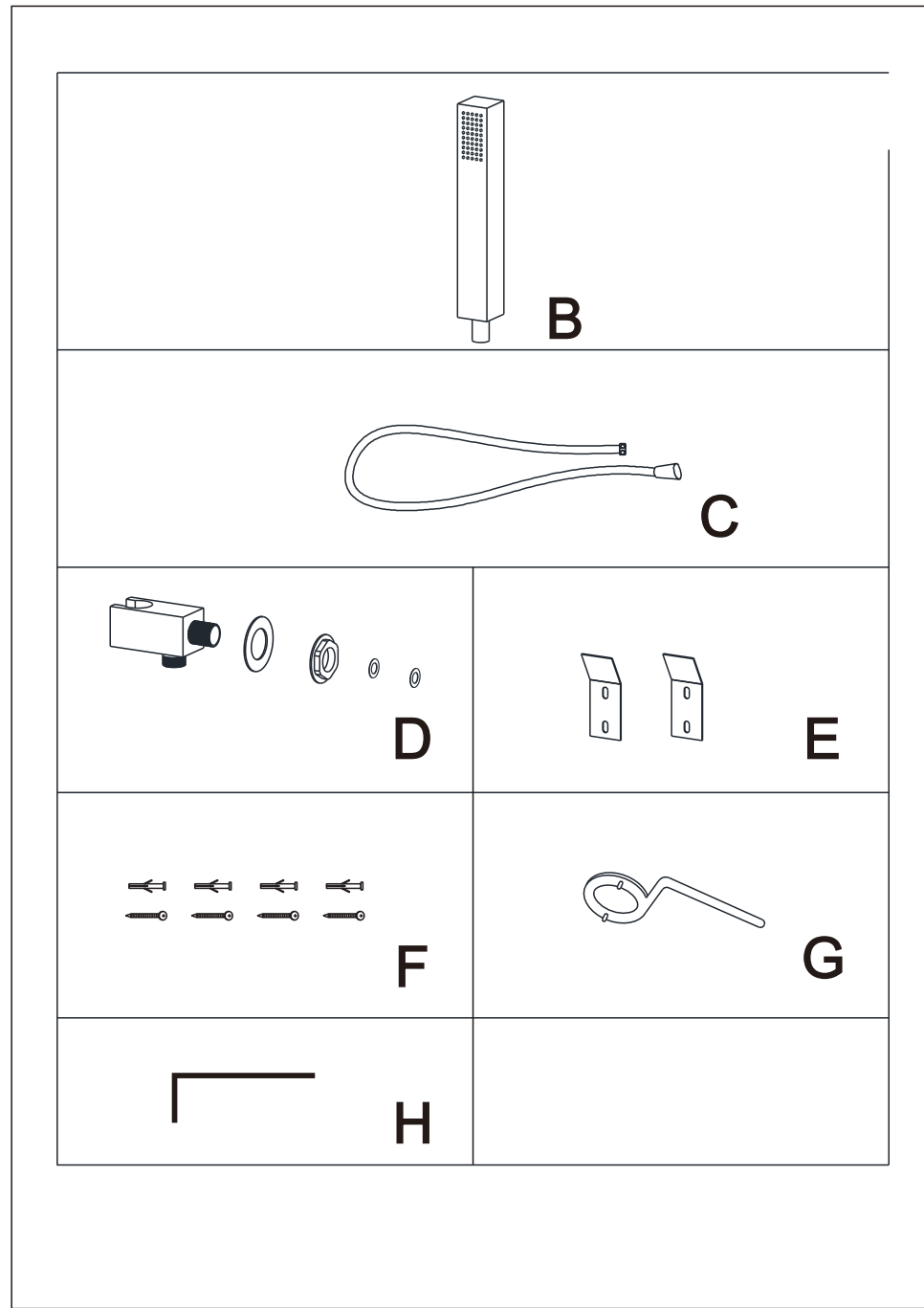

2

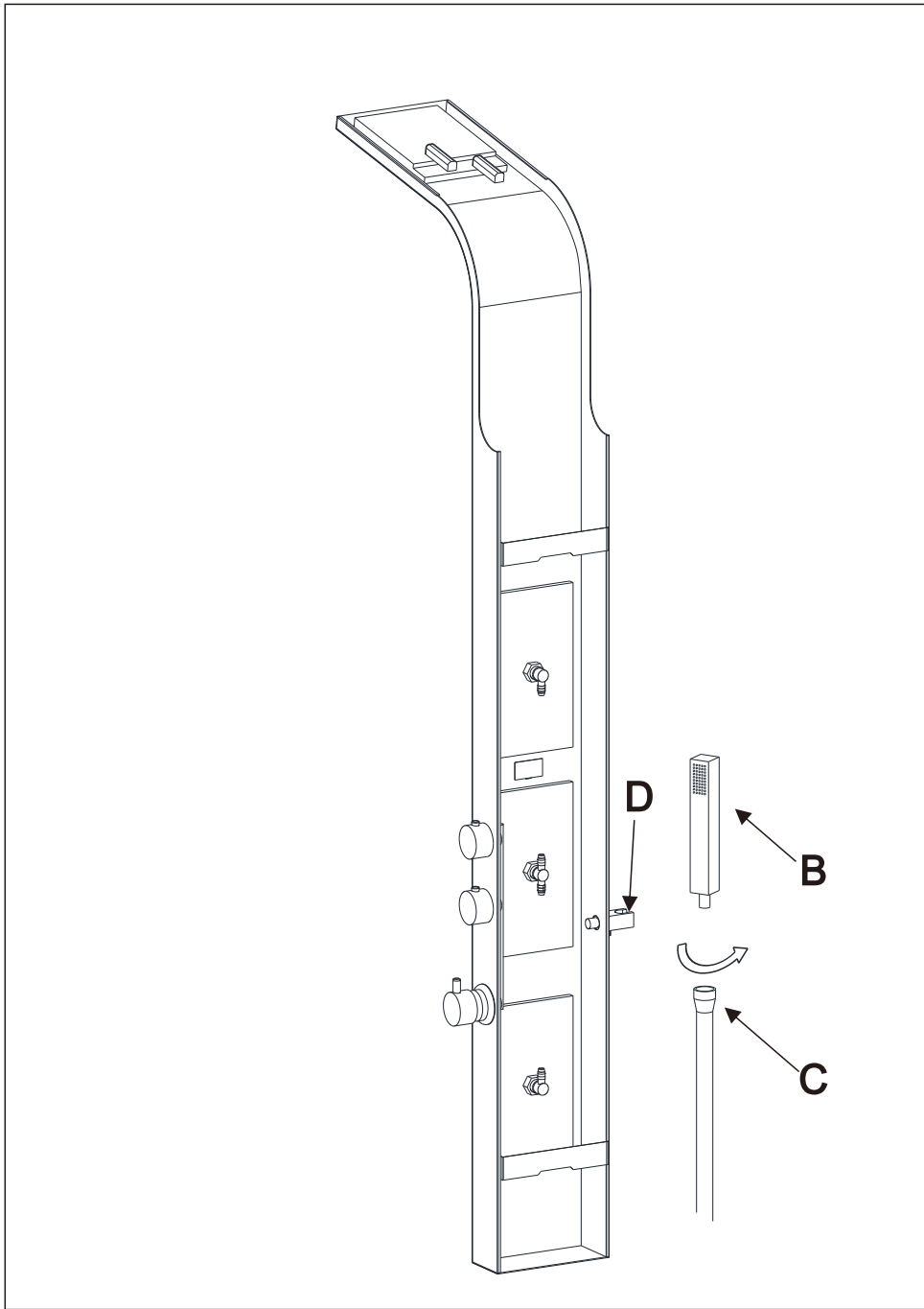

3

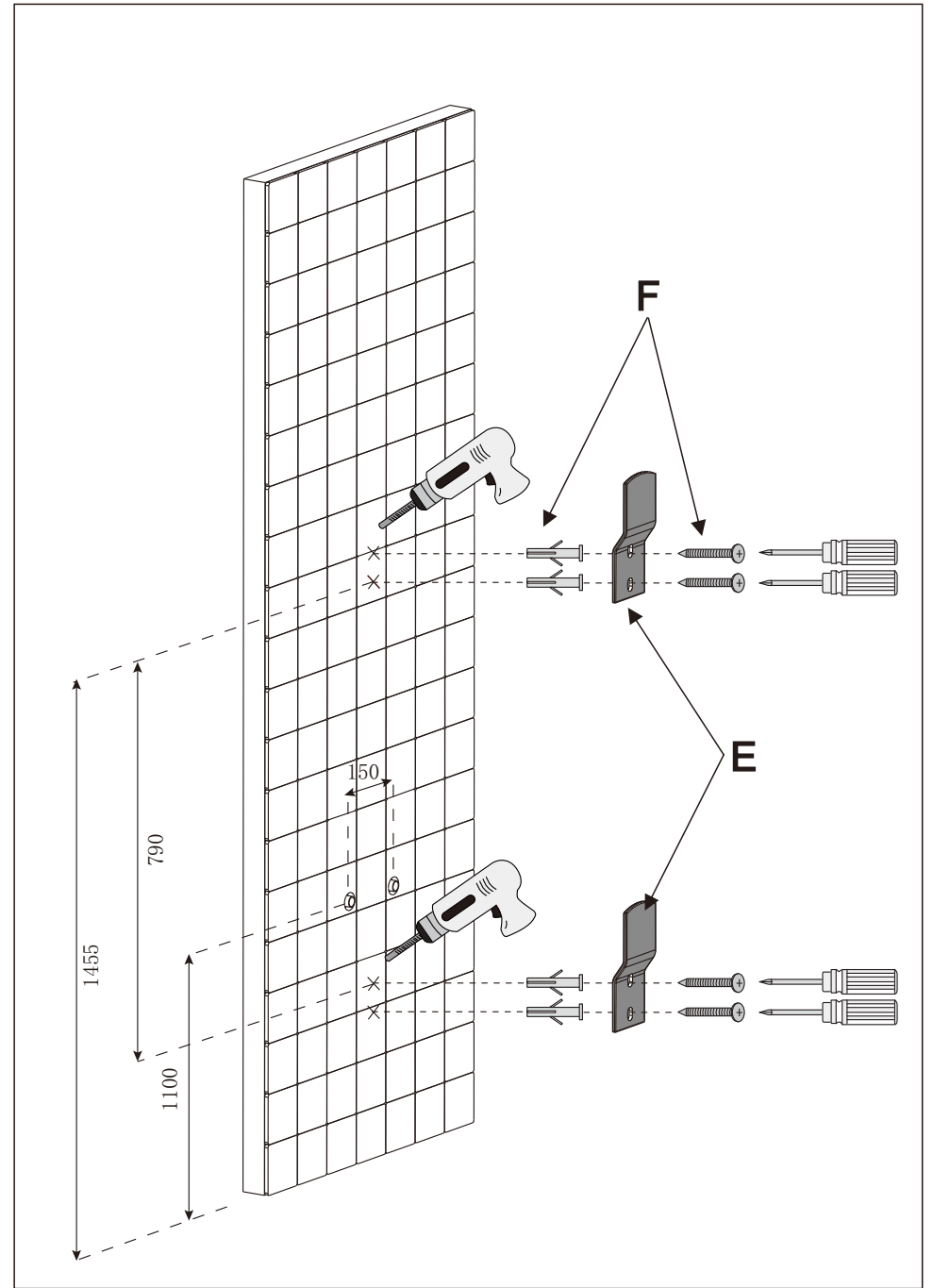

4