

# CASANOVO

## VEYMONT 300C160

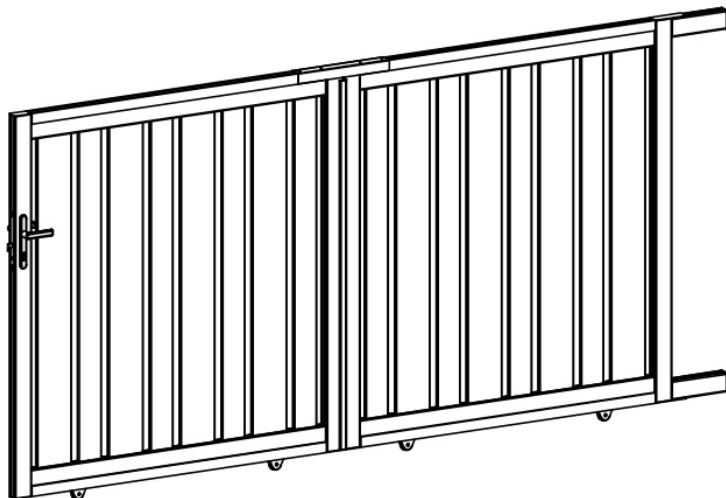

COM-000841 [x1]

COM-000842 [x1]

COM-00084 [x1]



INSTRUCTION MANUAL / NOTICE DE MONTAGE / MONTAGEANLEITUNG / MANUAL DE MONTAJE / MANUAL DE MONTAGEM / MANUALE DI MONTAGGIO /  
MONTAGEHANDLEIDING / INSTRUKCJA MONTAŻU / KÄYTTÖOHJEET / BRUKSANVISNING / BRUGSANVISNING / INSTRUCCIUNI DE ASAMBLARE /  
NAVODILA ZA SESTAVLJANJE / NÁVOD NA MONTÁŽ / ÖSSZESZERELÉSI ÚTMUTATÓ / NÁVOD K MONTÁŽI / UPUTE ZA INSTALACIJU /  
ΟΔΗΓΙΕΣ ΣΥΝΑΡΜΟΛΟΓΗΣΗΣ / SURINKIMO INSTRUKCIJOS / MONTĀŽAS INSTRUKCIJAS

**Ext.**

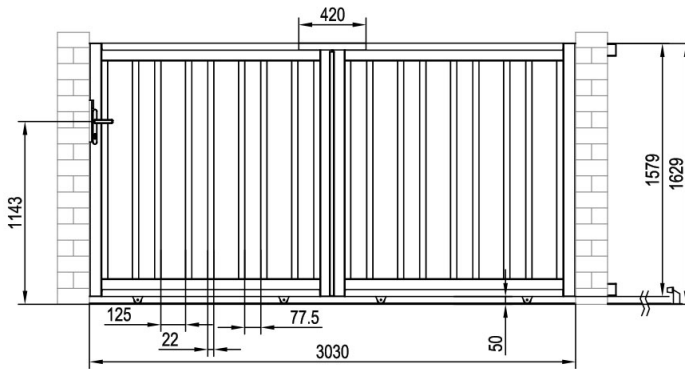

**Int.**

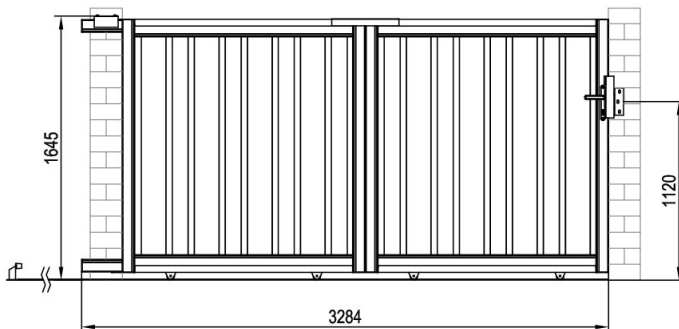

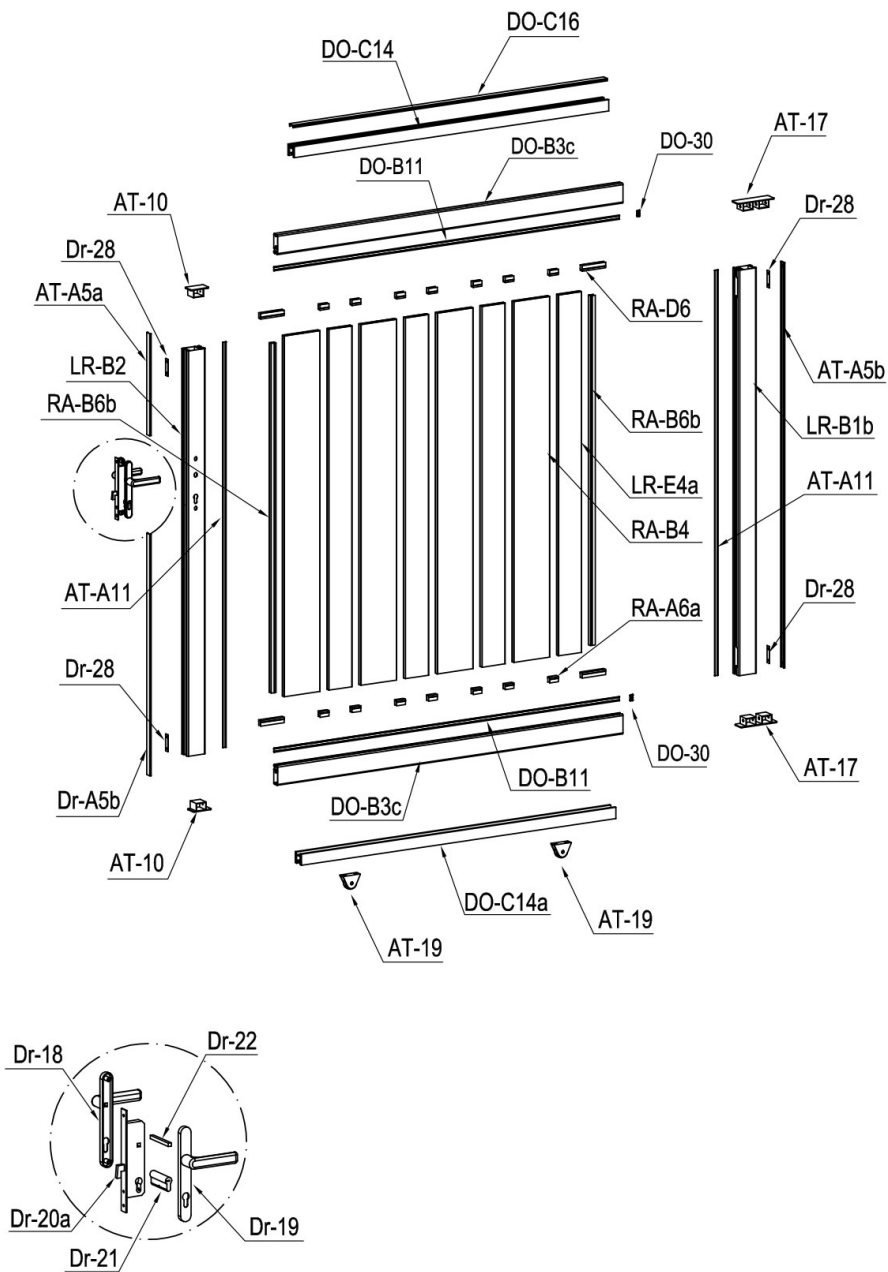

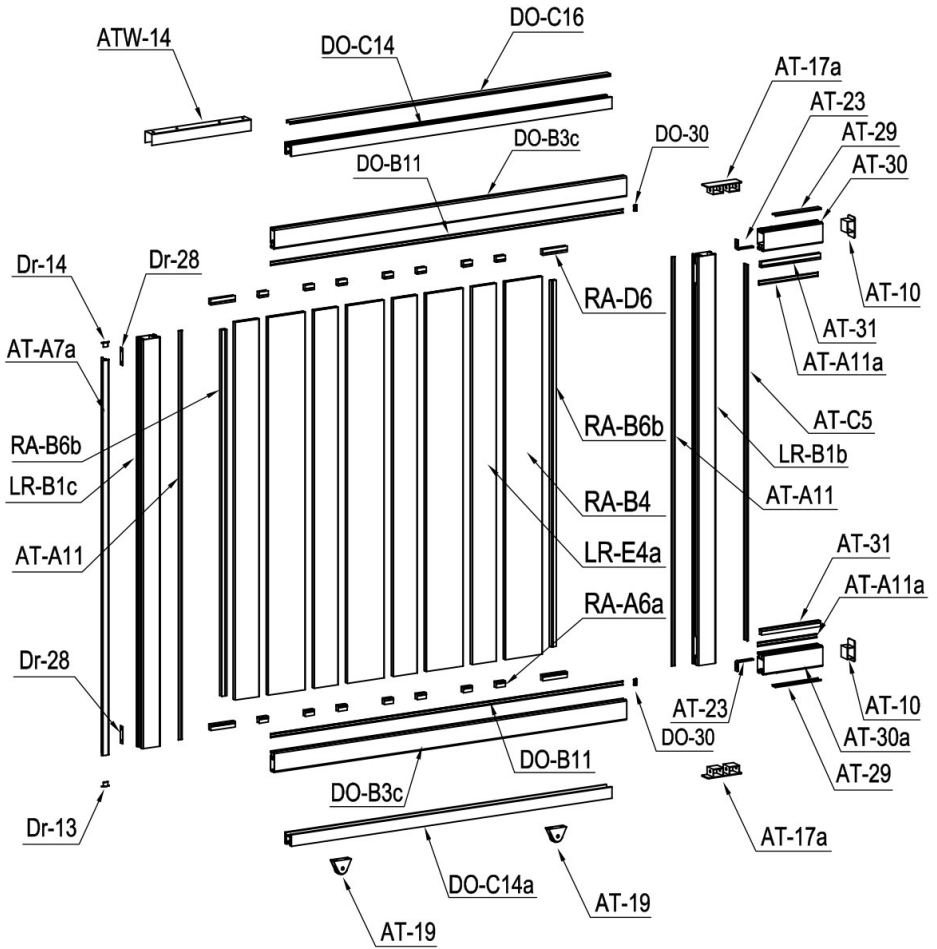

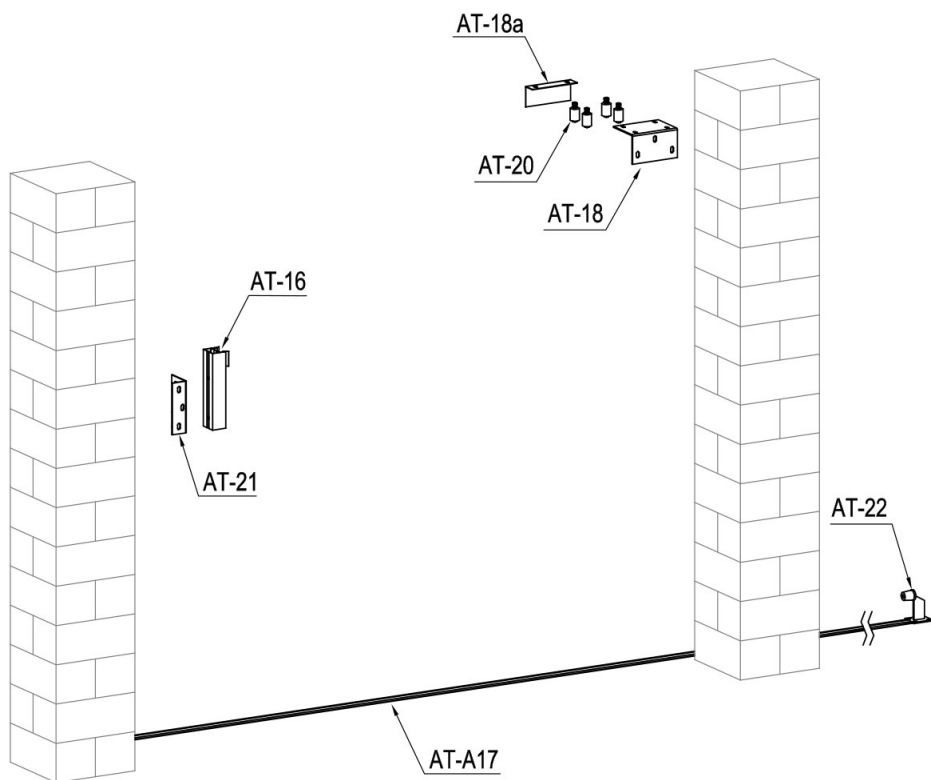















































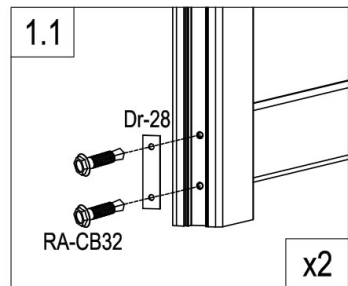
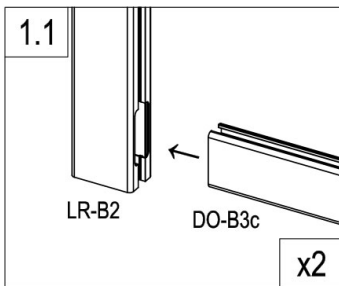
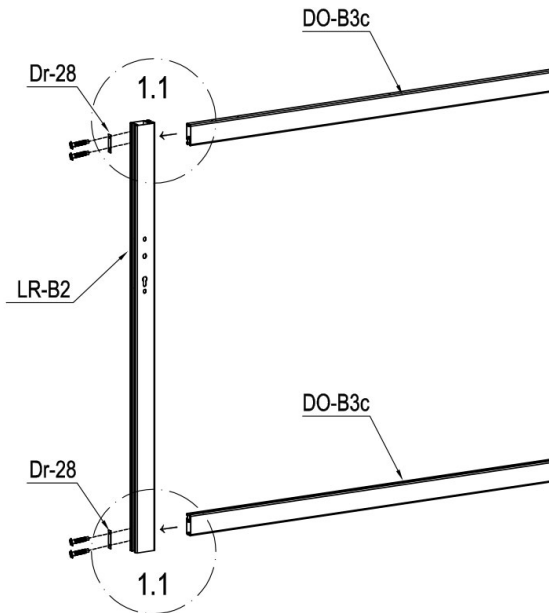

## PART LIST

IMAGE	NO.	L.(mm)	QTY	IMAGE	NO.	L.(mm)	QTY
	LR-B1b	1573	2		Dr-14		1
	LR-B1c	1573	1		DO-30		4
	LR-B2	1573	1		AT-18	150	1
	AT-30	250	1		AT-18a	150	1
	AT-30a	250	1		ATW-14	420	1
	DO-B3c	1492	4		AT-19		4
	RA-B4	1400	8		AT-20		4
	LR-E4a	1400	8		AT-21		1
	AT-A5b	1573	1		AT-22		1
	AT-C5	1448	1		AT-23		2
	AT-A5a	395.5	1		Dr-18		1
	Dr-A5b	937	1		Dr-19		1
	AT-29	193	2		Dr-20a		1
	AT-A11	1573	4		Dr-21		1
	AT-A11a	250	2		Dr-22		1
	DO-B11	1492	4		Dr-25	M5x45	1
	AT-31	250	2		Dr-25a	M5x60	2
	RA-A6a	38	28		Dr-27	ST4.2x25	2
	RA-B6b	1357	4		Dr-28		6
	RA-D6	102	8		AT-22J		7
	AT-A7a	1520	1		RA-CB30	ST4x10	4
	DO-C14	1358	2		RA-CB31	M8x60	10
	DO-C14a	1358	2		RA-CB32	ST5.5x38	28
	DO-C16	1357	2		RA-CB33	M8x130	4
	AT-16		1		RA-CB34	ST4.8x38	12
	AT-A17	1212	5		RA-CB35	ST4.2x19	54
	AT-17		2		RA-CB36	M6x20	2
	AT-17a		2		RA-CB37	M8x20	8
	AT-10		4		RA-CB38	M4x25	40
	Dr-13		1				





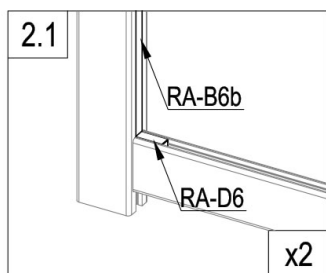
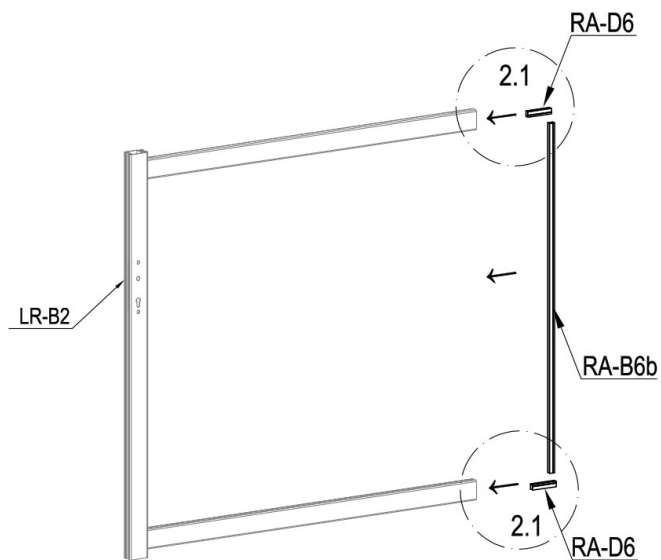

	LR-B2	1
	DO-B3c	2
	Dr-28	2
	RA-CB32	4

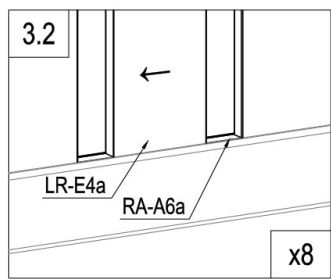
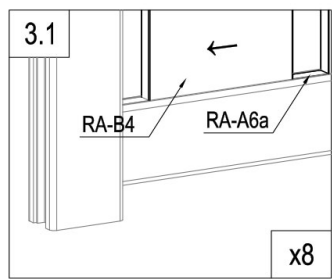
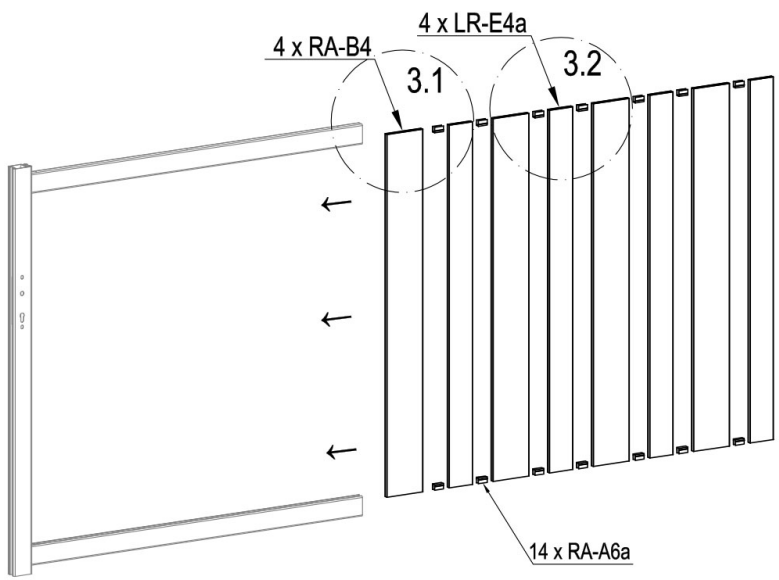

☐	RA-D6	2
	RA-B6b	1







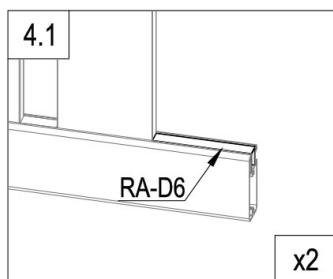
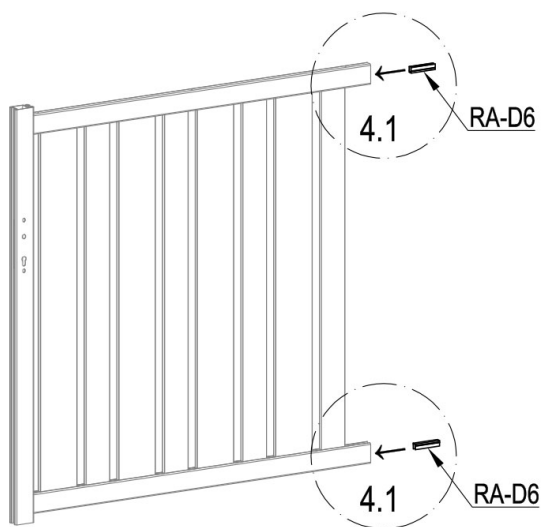

	RA-B4	4
	LR-E4a	4
	RA-A6a	14

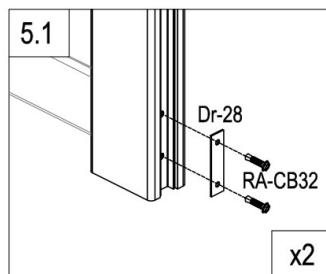
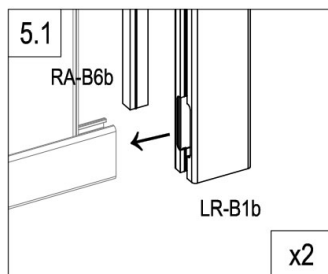
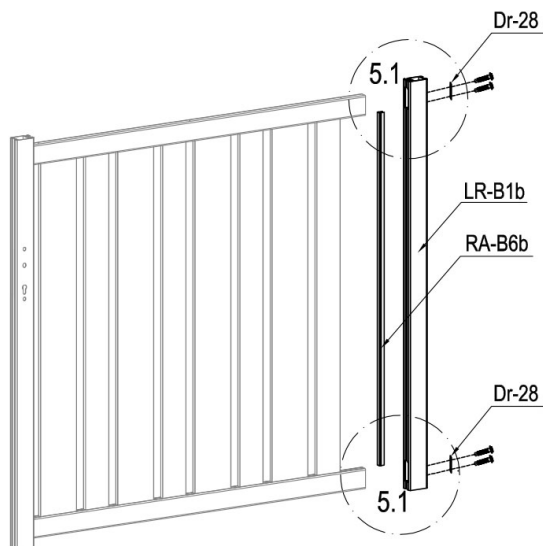



	RA-D6	2
---	-------	---

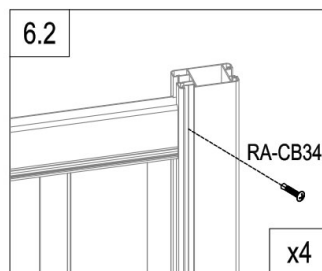
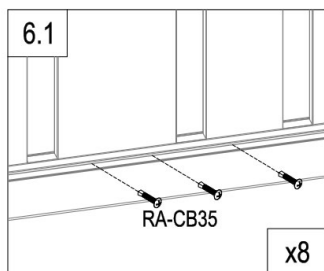
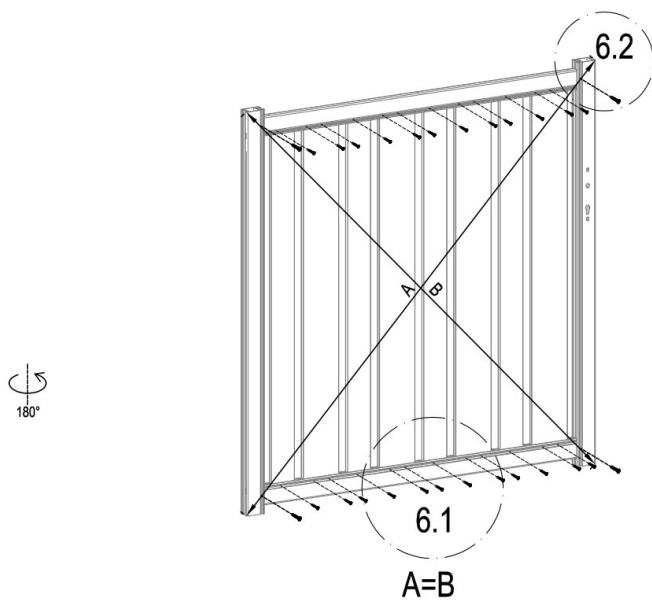

	LR-B1b	1
	RA-B6b	1
	Dr-28	2
	RA-CB32	4



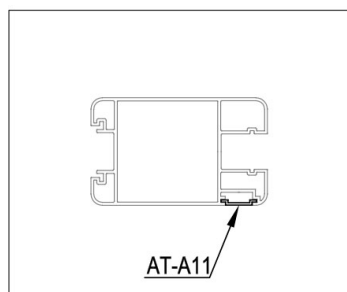
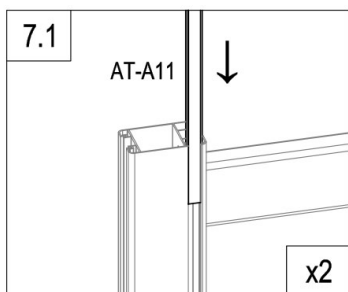
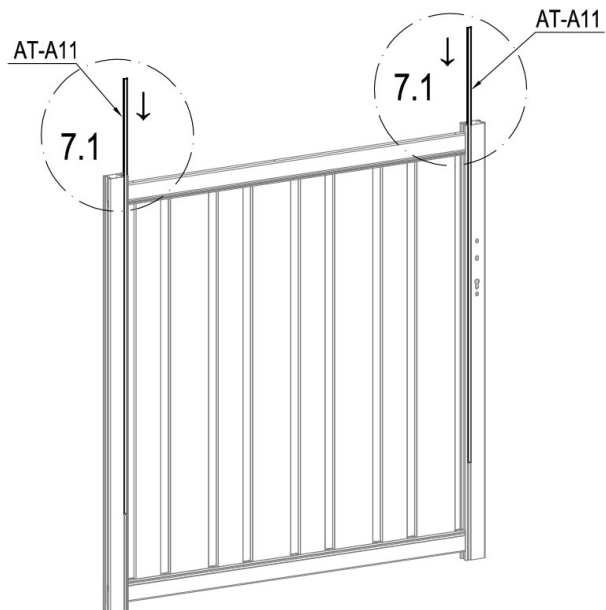

	RA-CB35	24
	RA-CB34	4

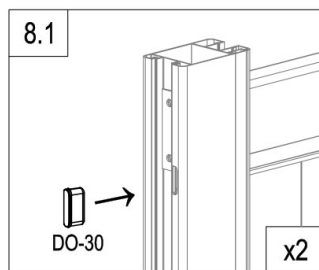
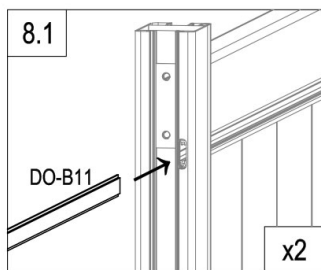
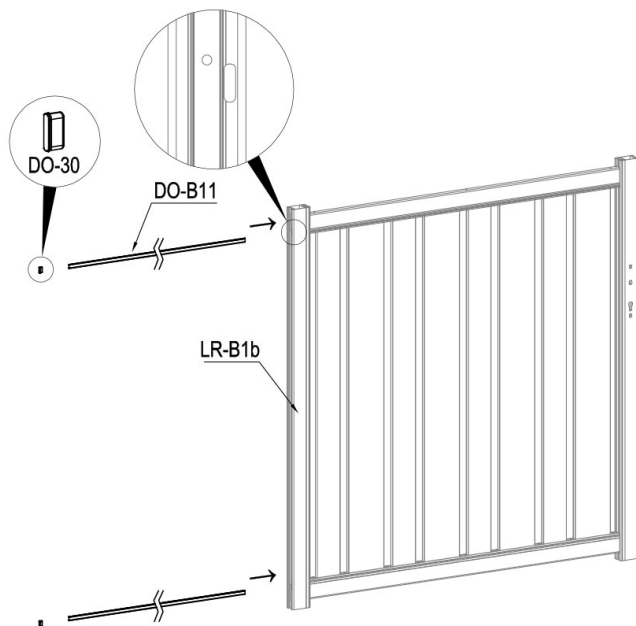

	AT-A11	2
---	--------	---



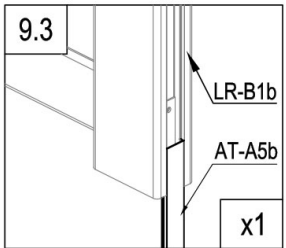
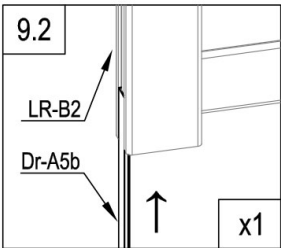
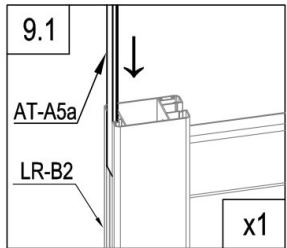
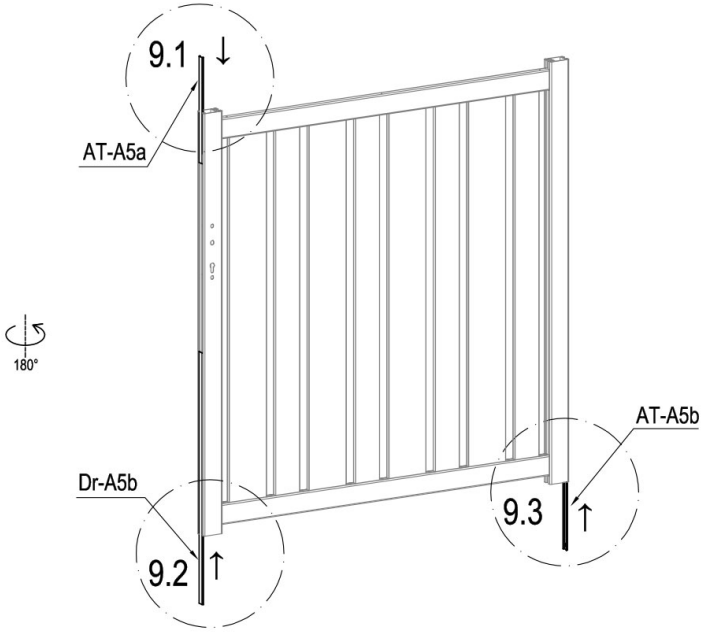

	DO-B11	2
	DO-30	2

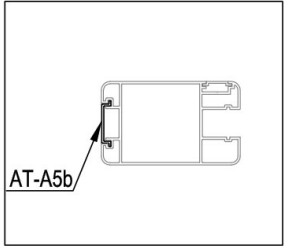

	AT-A5b	1
	AT-A5a	1
	Dr-A5b	1

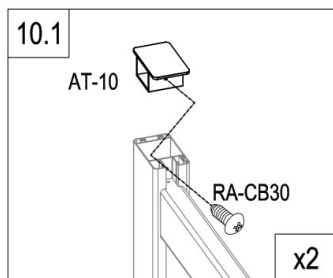
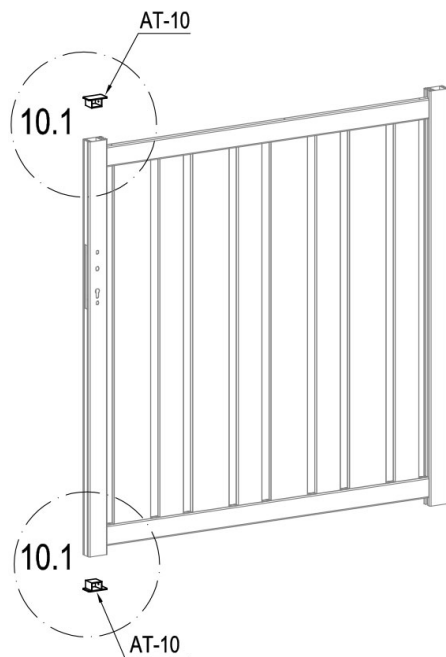





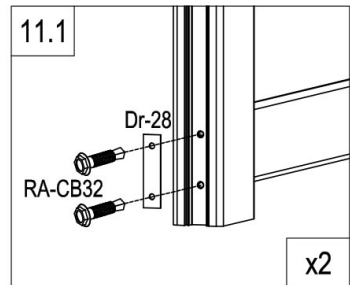
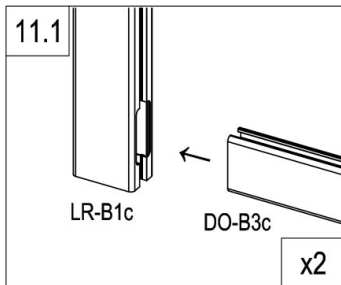
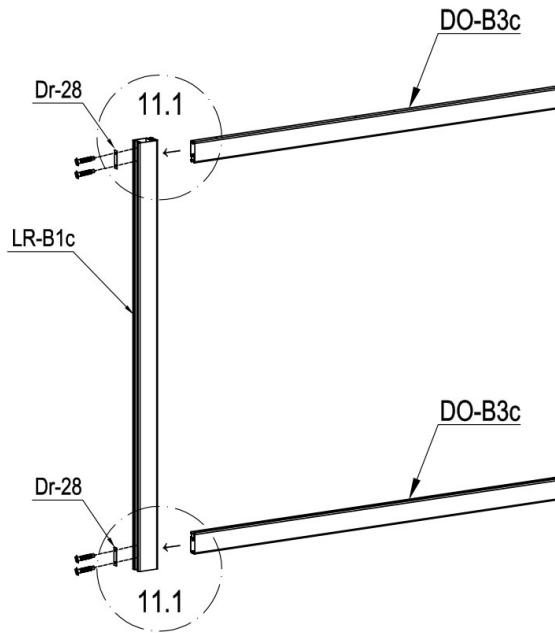

	AT-10	2
	RA-CB30	2







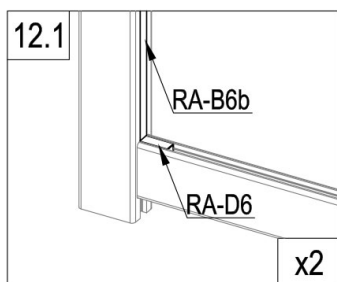
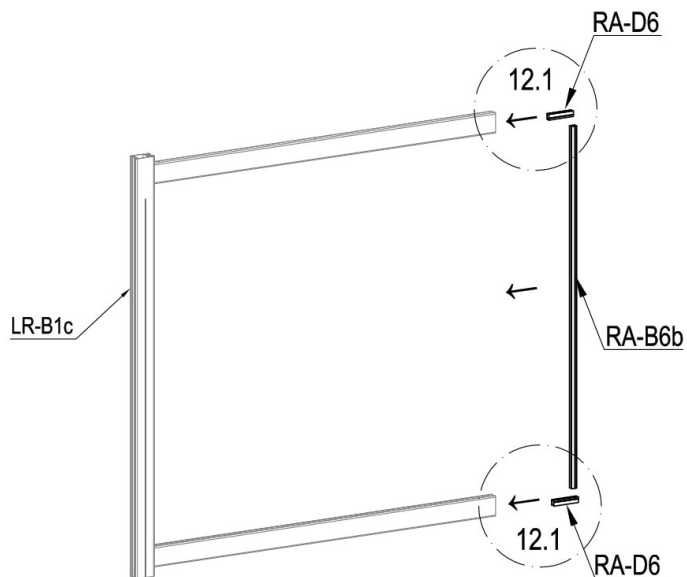

	LR-B1c	1
	DO-B3c	2
	Dr-28	2
	RA-CB33	4

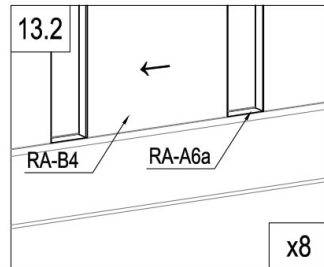
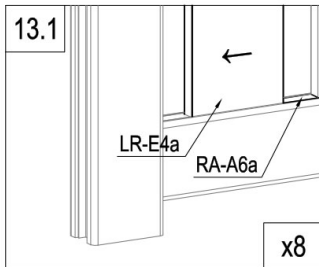
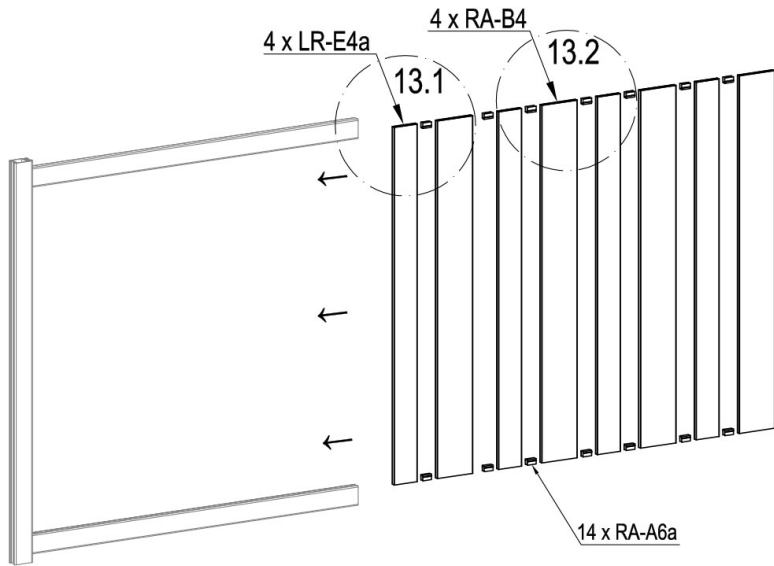

C	RA-D6	2
	RA-B6b	1



	RA-B4	4
	LR-E4a	4
	RA-A6a	14

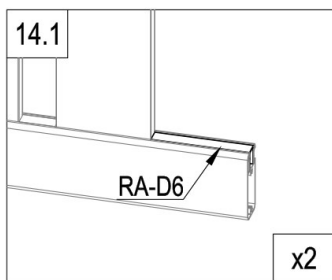
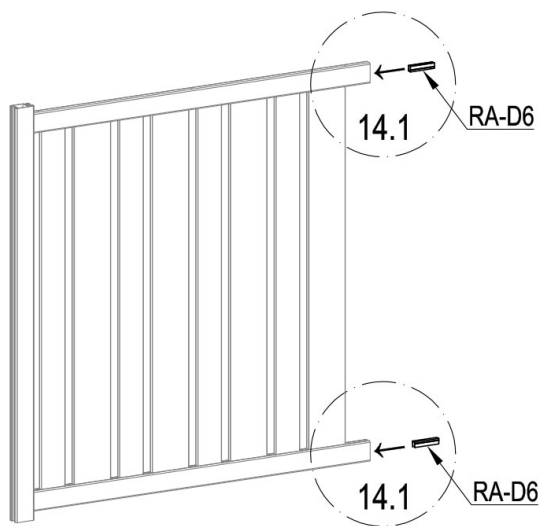

	RA-D6	2
---	-------	---

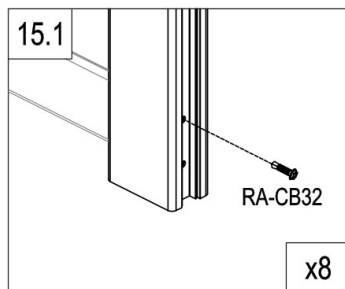
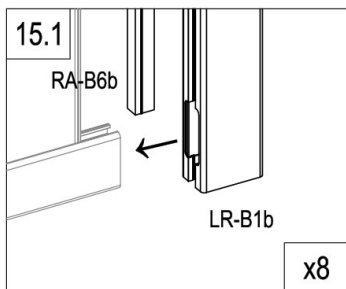
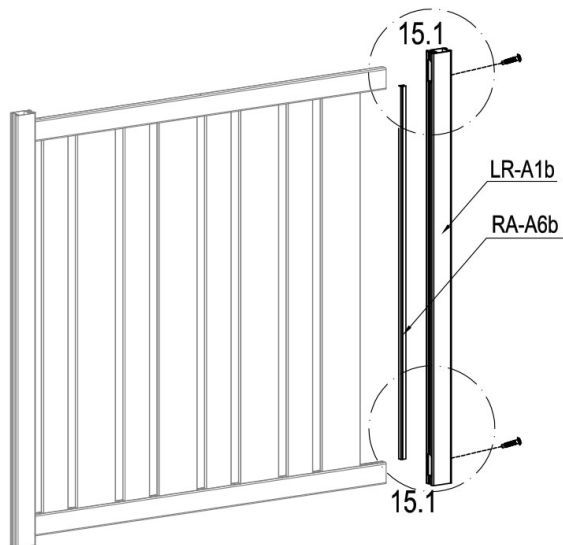

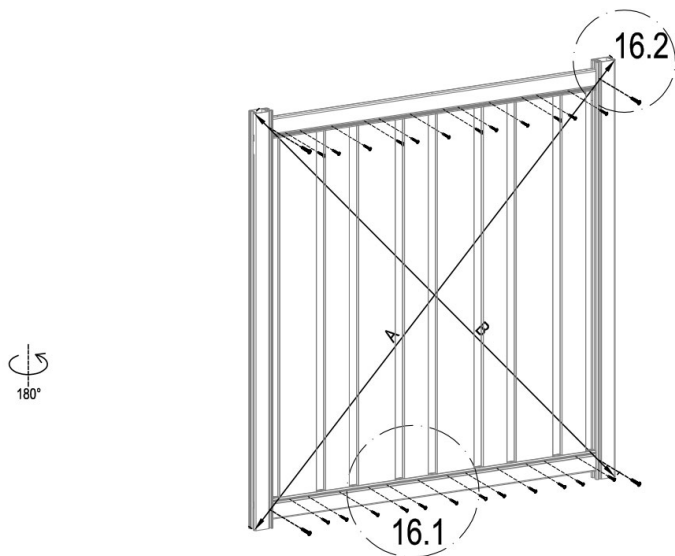

	LR-B1b	1
	RA-B6b	1
	RA-CB32	2

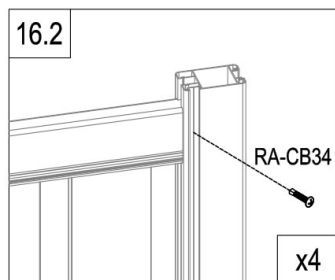
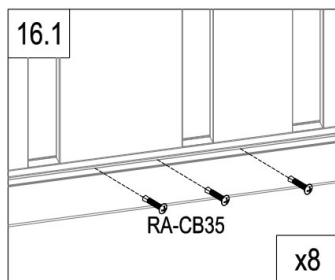

A=B



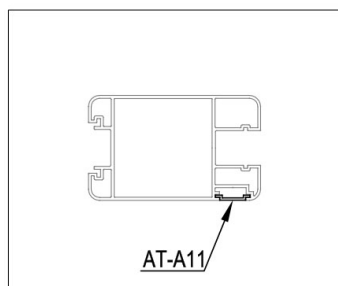
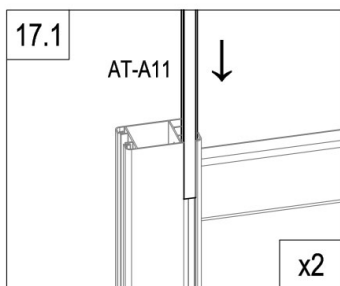
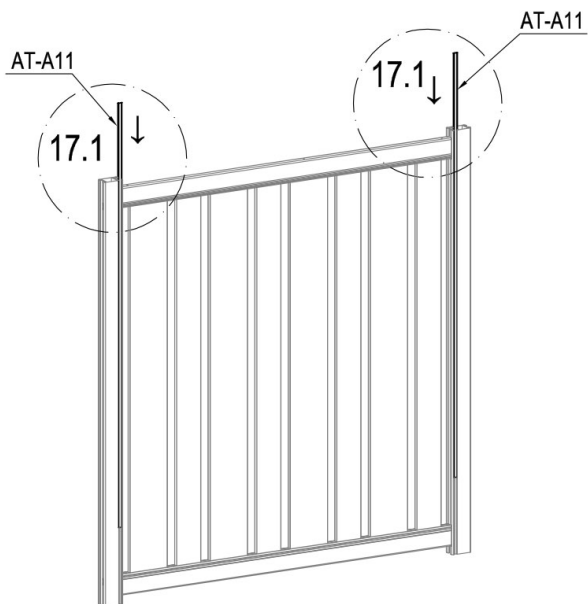

	RA-CB35	24
	RA-CB34	4



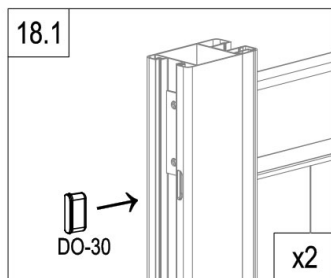
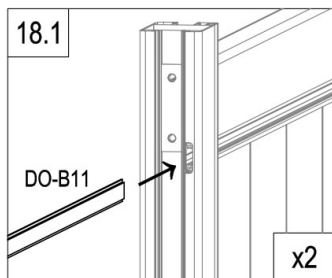
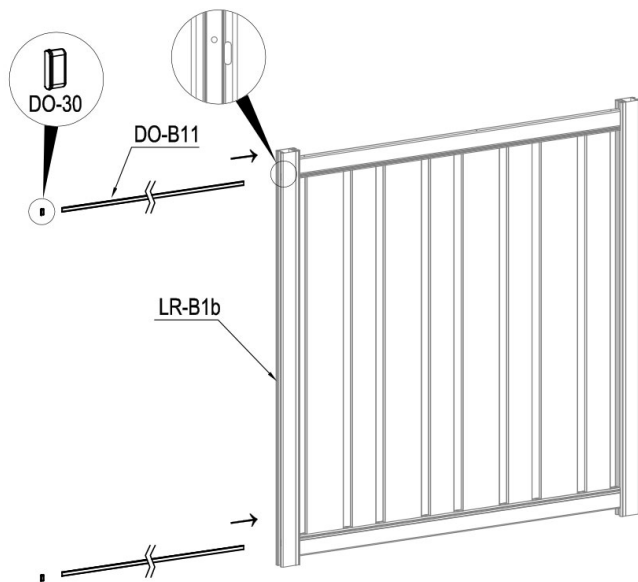



	<b>AT-A11</b>	<b>2</b>
---	---------------	----------

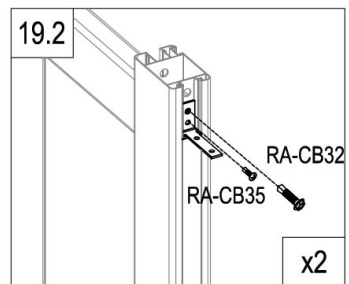
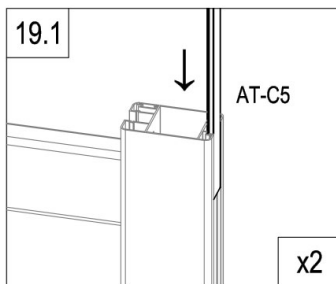
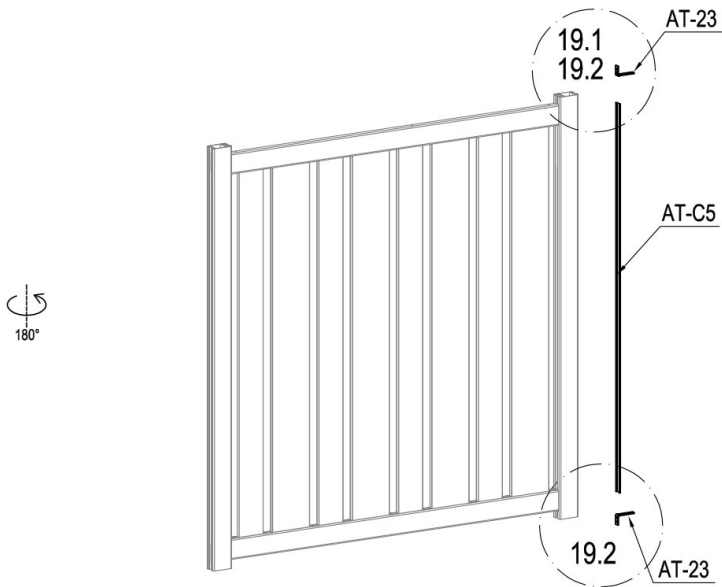

	DO-B11	2
	DO-30	2





	AT-C5	1
	AT-23	2
	RA-CB32	2
	RA-CB35	2

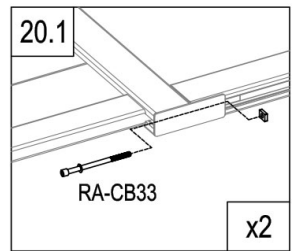
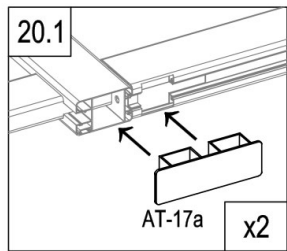
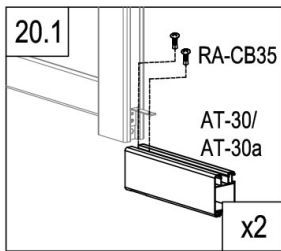
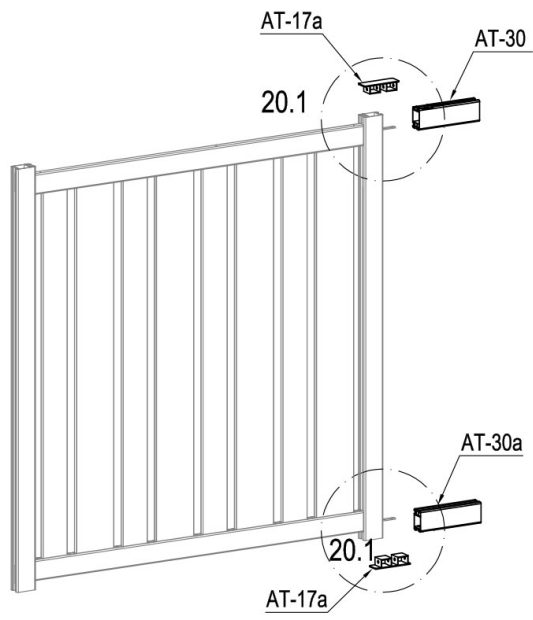

	AT-30	1
	AT-30a	1
	AT-17a	2

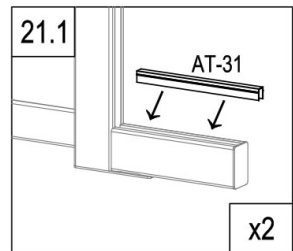
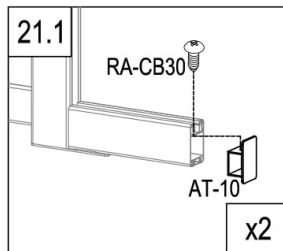
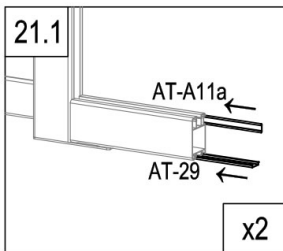
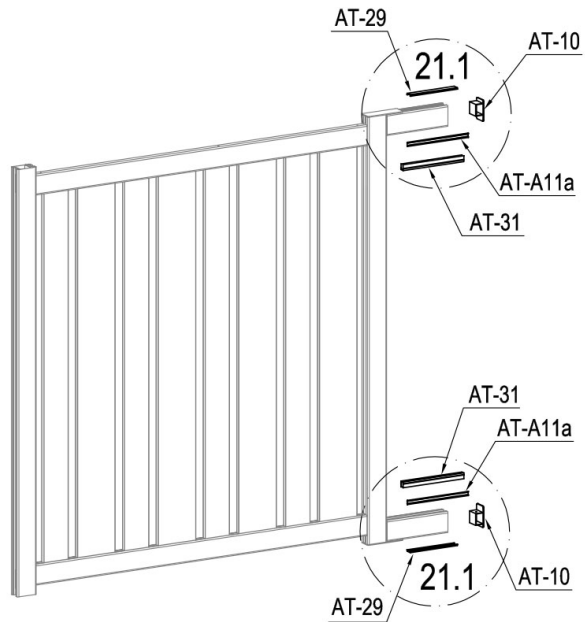

	RA-CB33	2
	RA-CB35	4



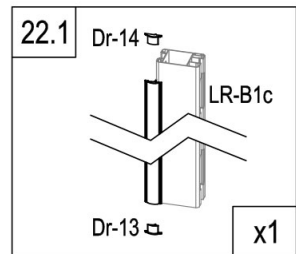
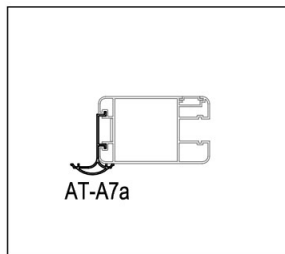
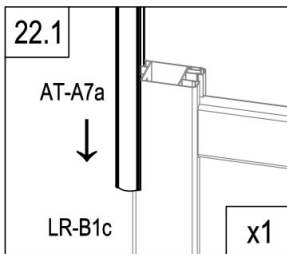
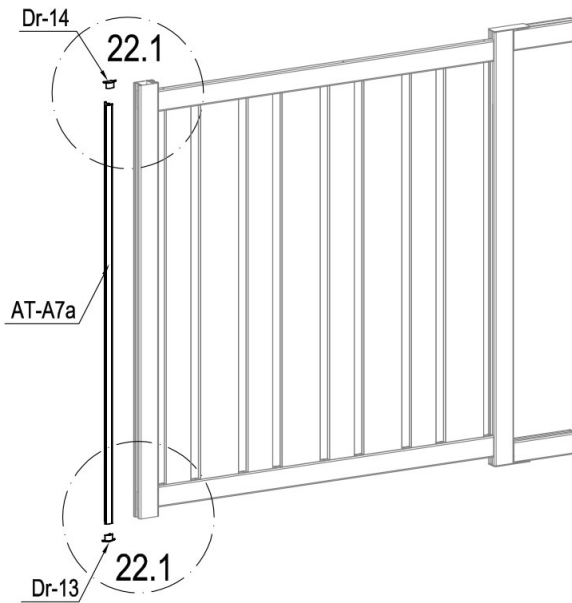

	AT-29	2
	AT-A11a	2
	AT-31	2

	AT-10	2
	RA-CB30	2

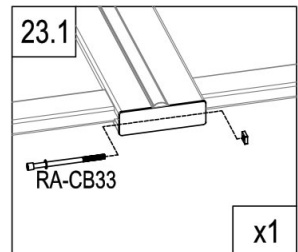
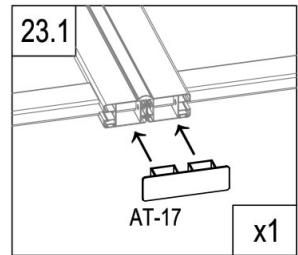
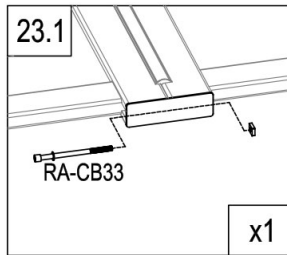
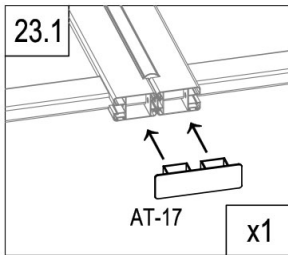
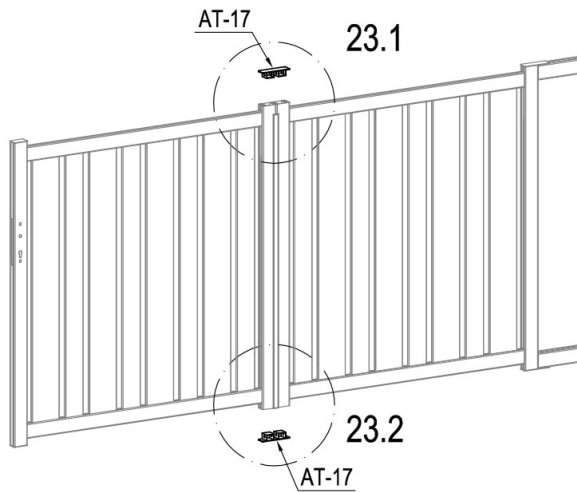

	AT-A7a	1
	Dr-13	1
	Dr-14	1



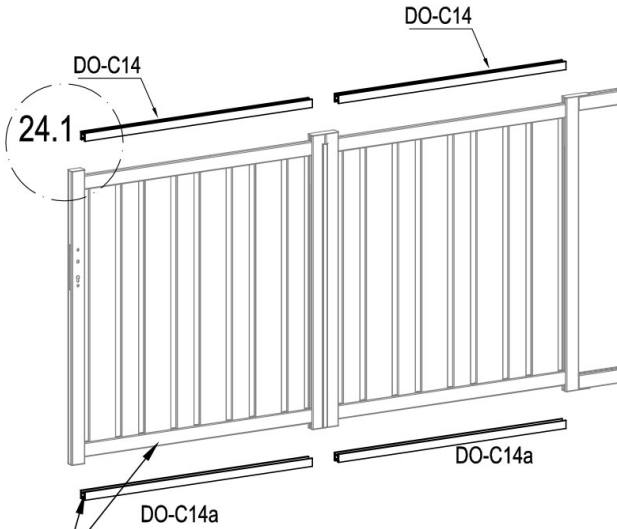

	AT-17	2
	RA-CB33	2



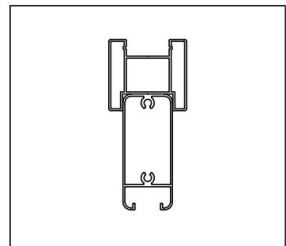
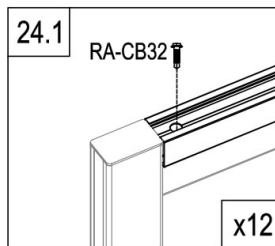
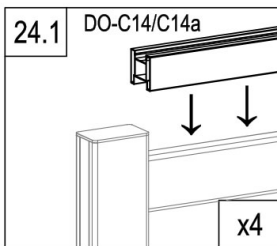

EN: These parts are made for connecting your gate's automation  
 FR: Ces pièces sont faites pour relier l'automatisation de votre portail  
 DE: Diese Teile sind für den Anschluss der Automatisierung Ihres Tores vorgesehen  
 ES: Estas piezas están hechas para conectar la automatización de su puerta  
 PT: Estas peças são feitas para ligar a automatização do seu portão  
 IT: Queste parti sono realizzate per collegare l'automazione del vostro cancello  
 NL: Deze onderdelen zijn gemaakt voor het aansluiten van de automatisering van uw poort.  
 PL: Te części są wykonane do podłączenia automatyki bramy.



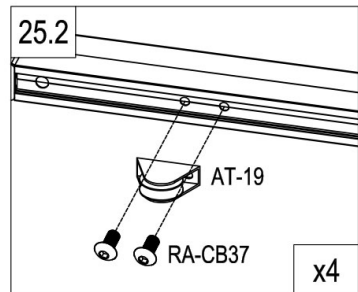
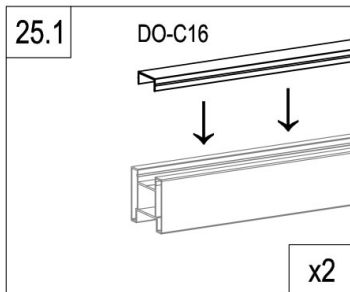
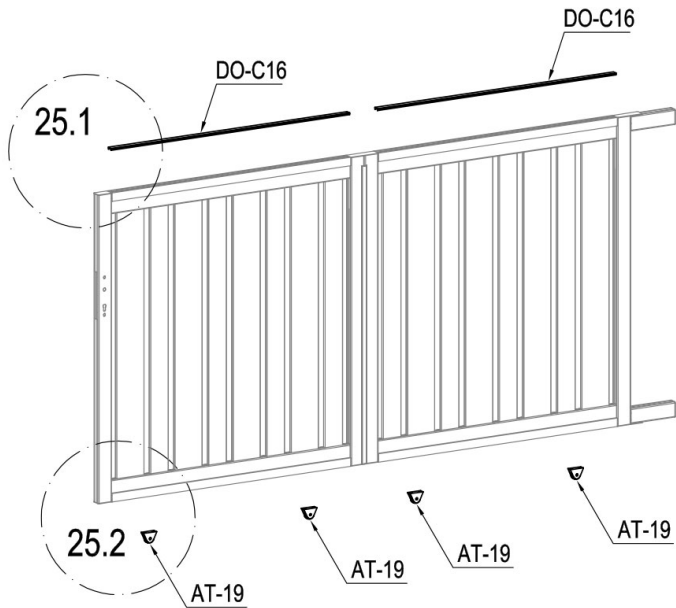

	DO-C14	2
	DO-C14a	2
	RA-CB32	12

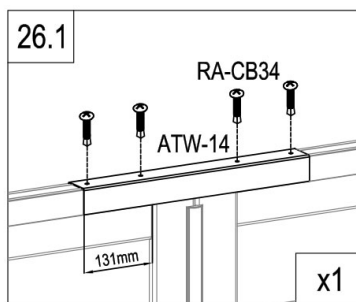
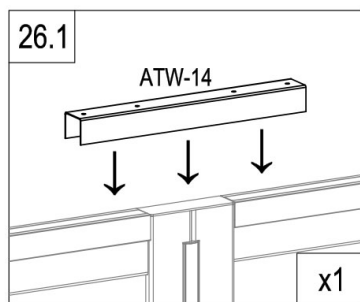
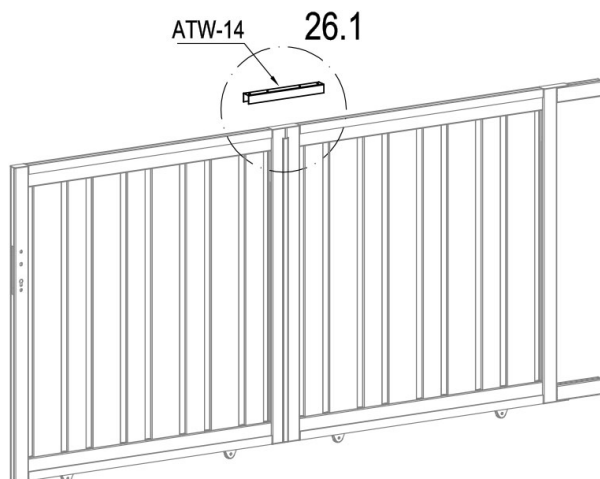

	DO-C16	2
	AT-19	4
	RA-CB37	8



	ATW-14	1
	RA-CB34	4



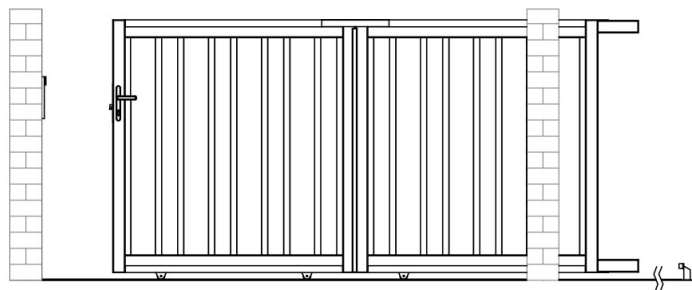

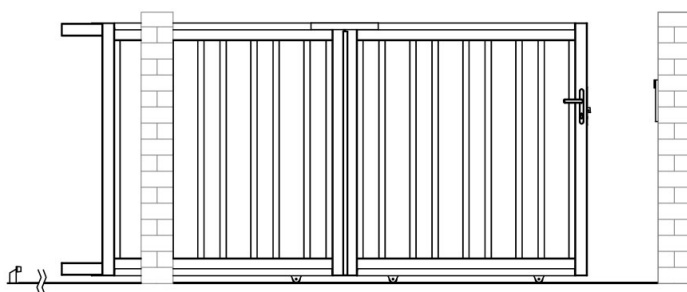

**L** : P27~32

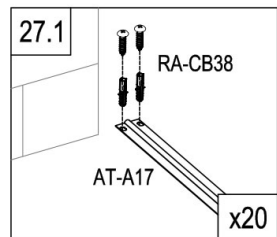
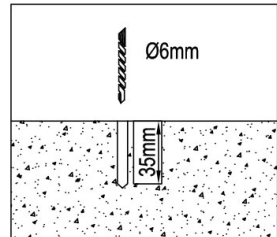
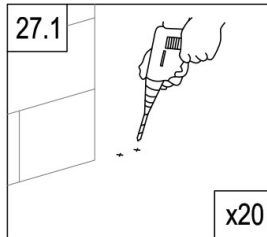
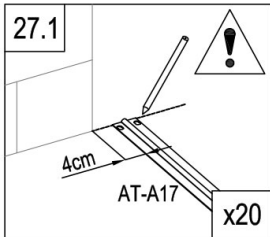
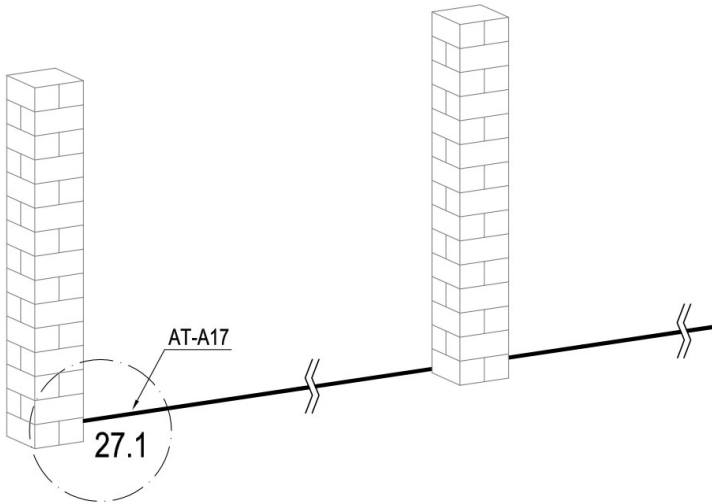

**R** : P33~38

L



	AT-A17	5
	RA-CB38	40

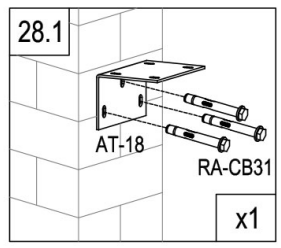
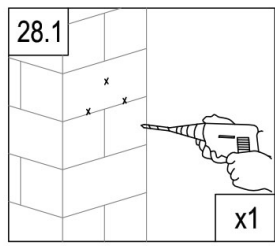
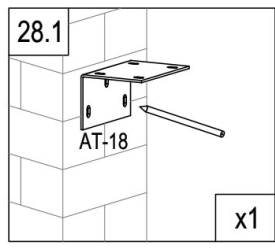
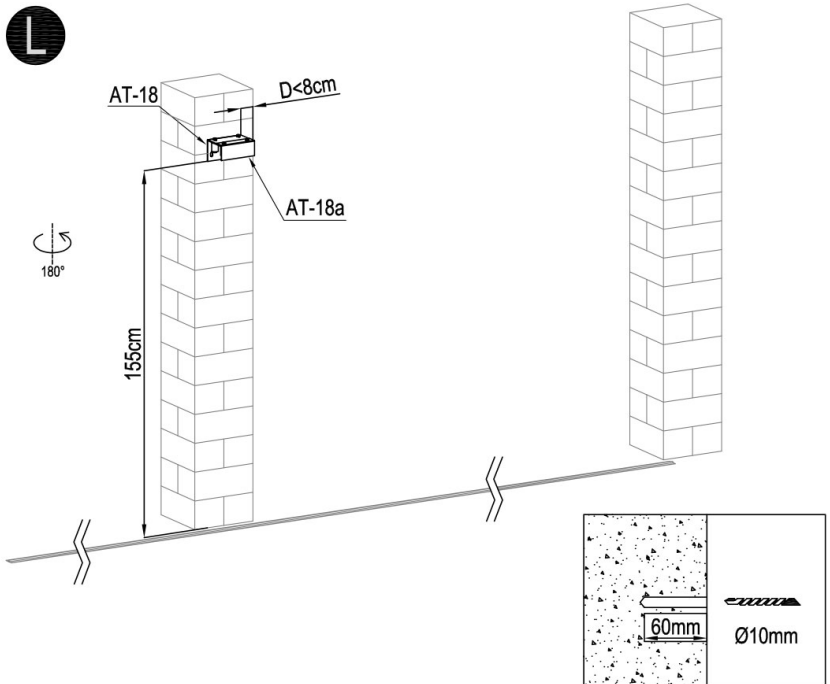

	AT-18	1
	AT-18a	1
	AT-20	4
	RA-CB31	3

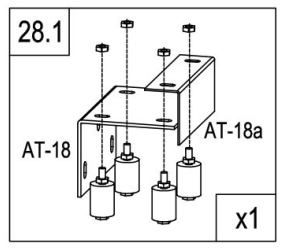
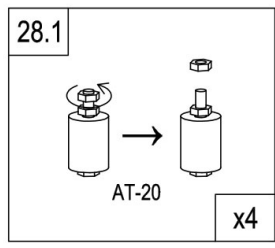

L

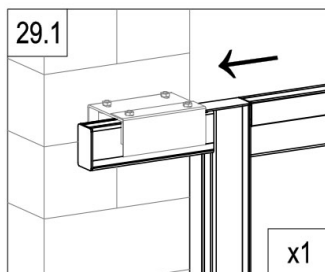
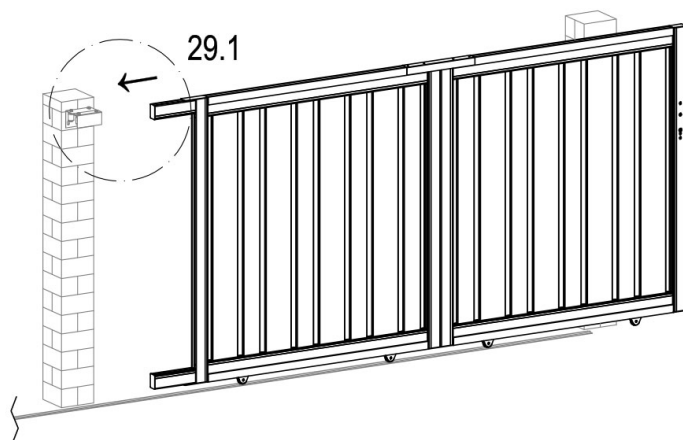

L

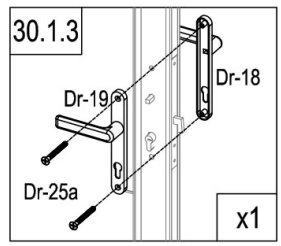
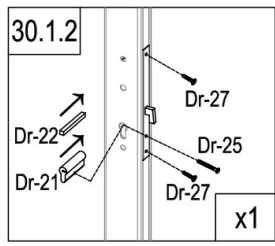
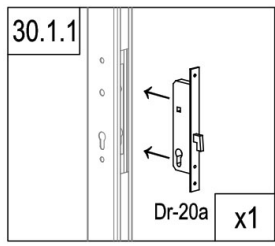
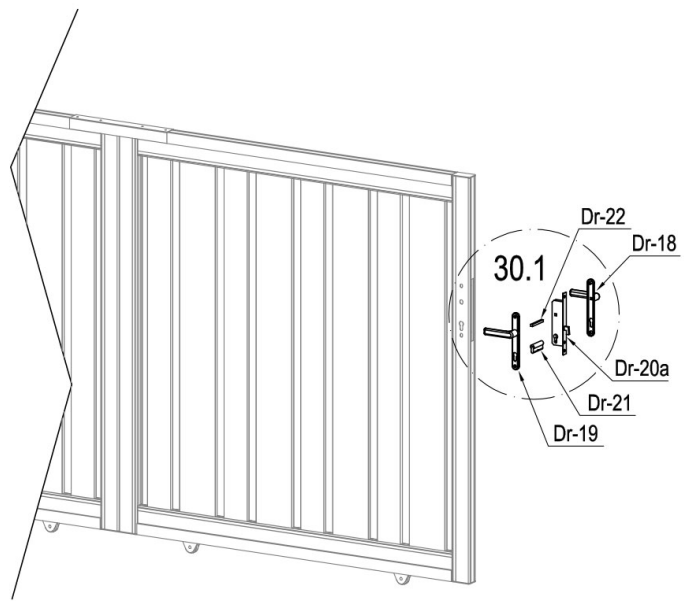

	Dr-20a	1
	Dr-21	1
	Dr-22	1
	Dr-25	1

	Dr-18	1
	Dr-19	1
	Dr-25a	2
	Dr-27	2

L

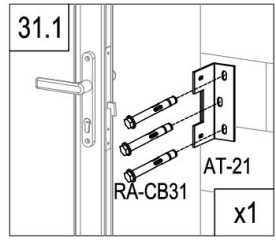
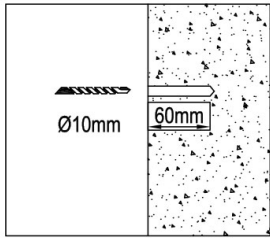
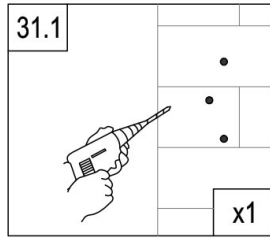
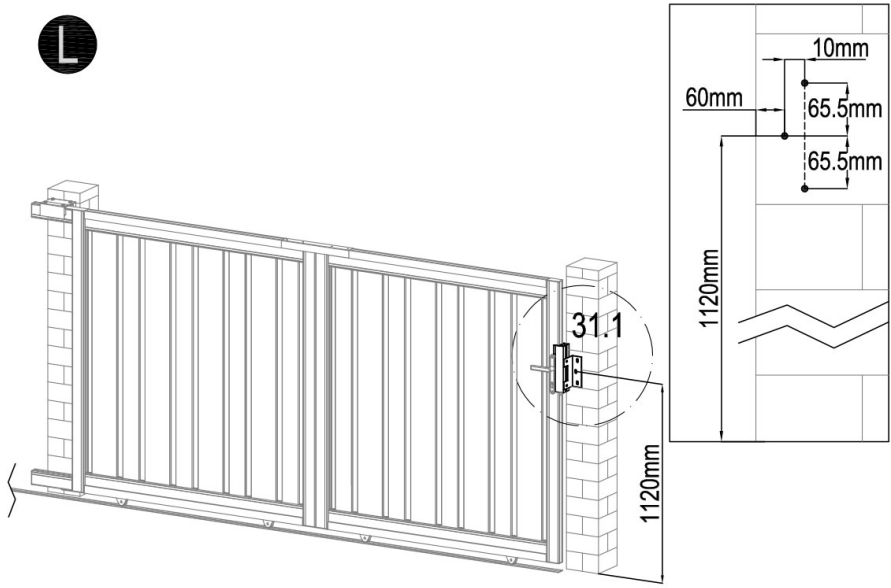

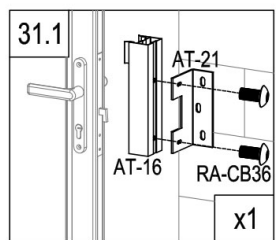
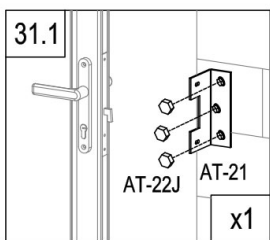

	AT-16	1
	AT-21	1
	RA-CB36	2
	RA-CB31	3
	AT-22J	3

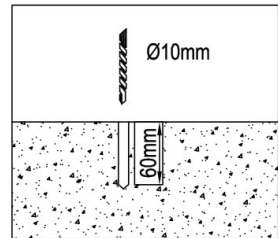
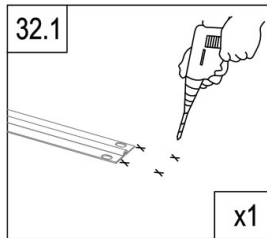
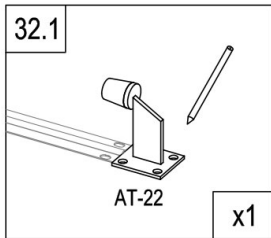
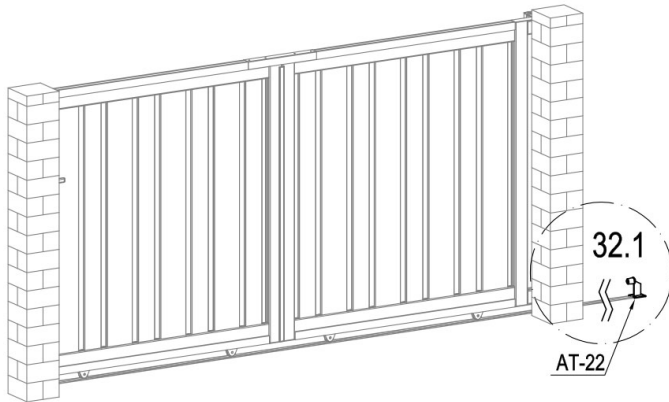

L



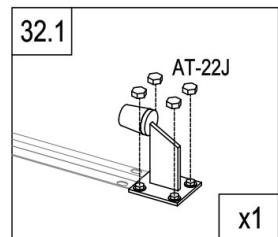
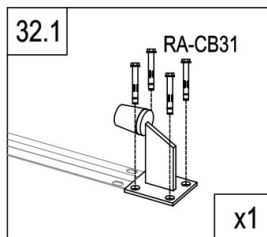

	AT-22	1
	RA-CB31	4
	AT-22J	4

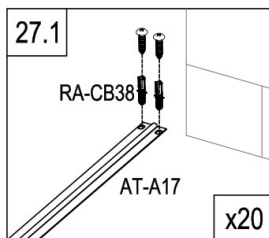
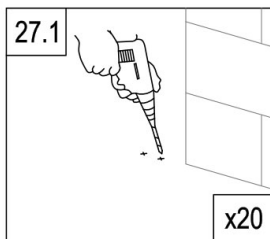
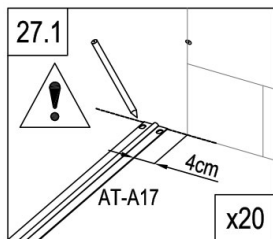
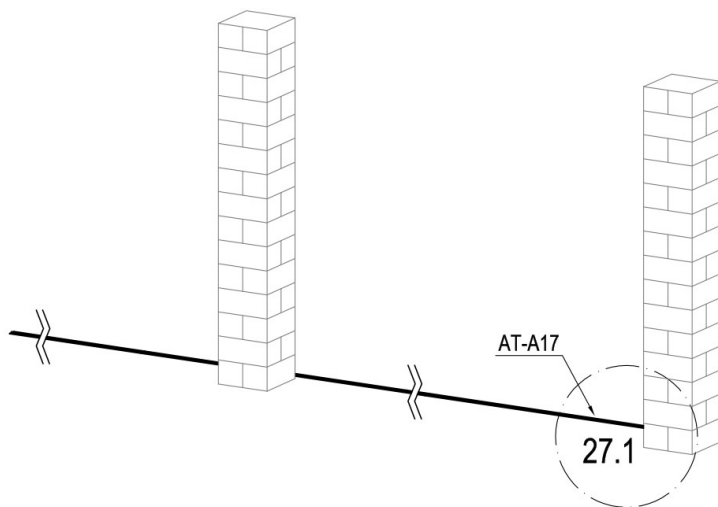

R



	AT-A17	5
	RA-CB38	40



**R**

180°

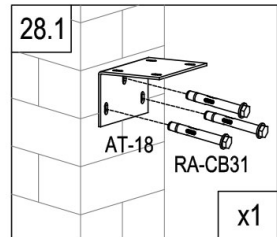
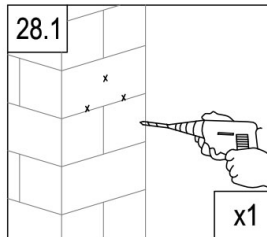
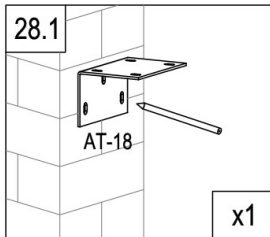
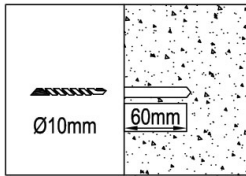
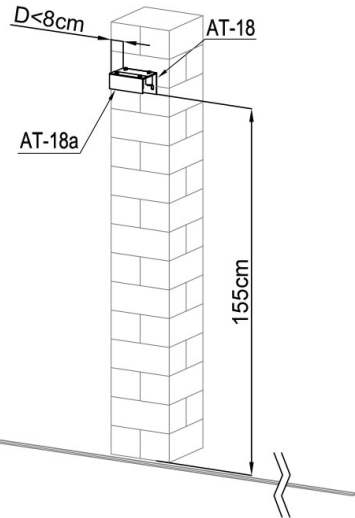

	AT-18	1
	AT-18a	1
	AT-20	4
	RA-CB31	3

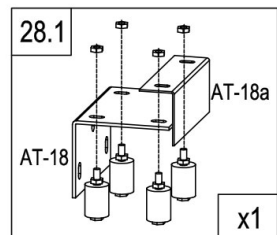
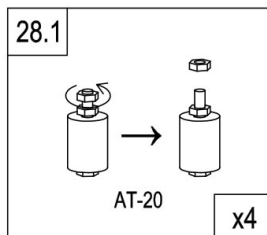

R

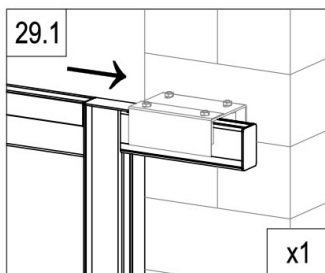
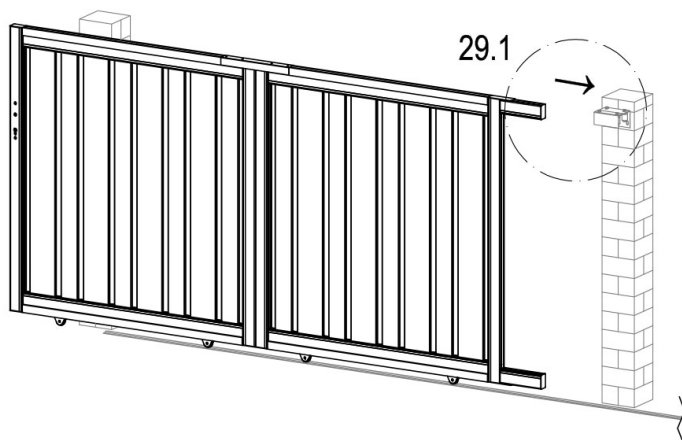

**R**

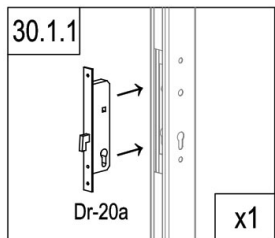
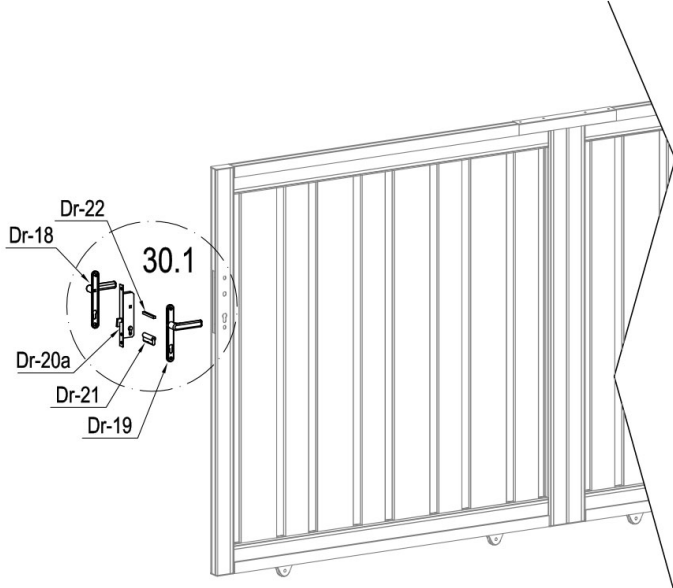

	Dr-20a	1
	Dr-21	1
	Dr-22	1
	Dr-25	1

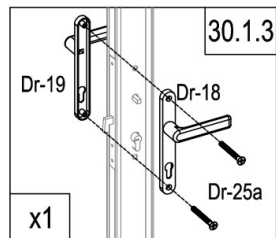
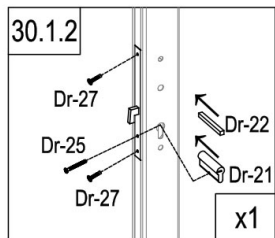

	Dr-18	1
	Dr-19	1
	Dr-25a	2
	Dr-27	2

R

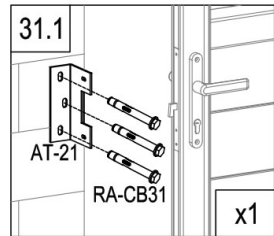
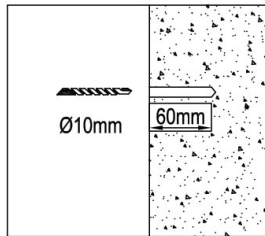
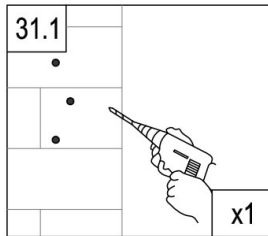
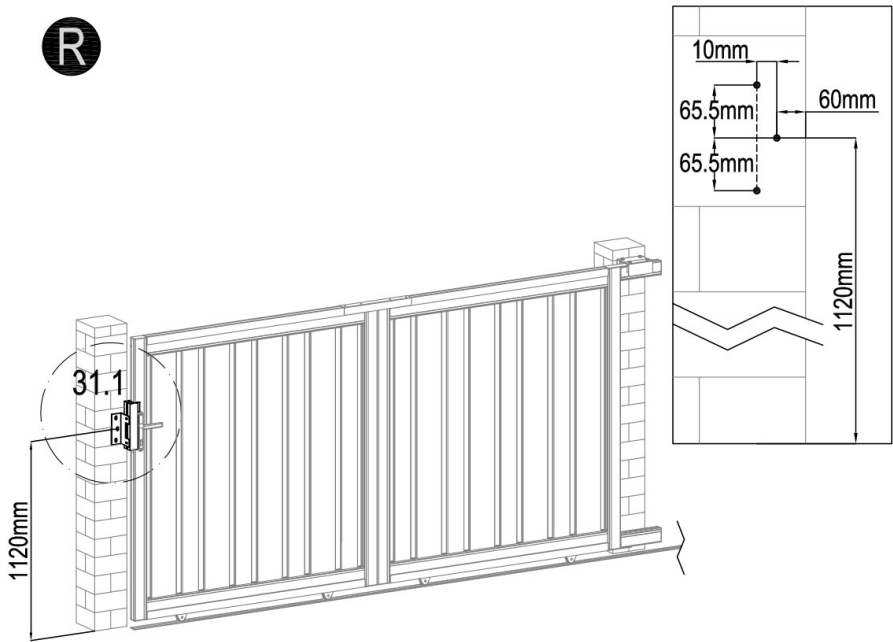

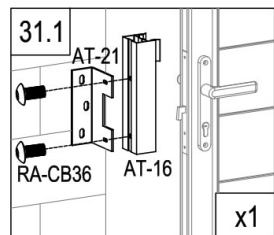
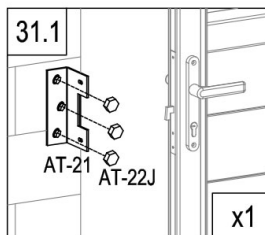

	AT-16	1
	AT-21	1
	RA-CB36	2
	RA-CB31	3
	AT-22J	3

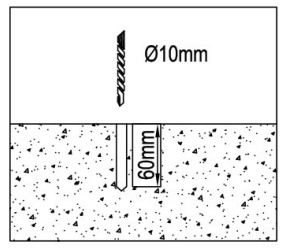
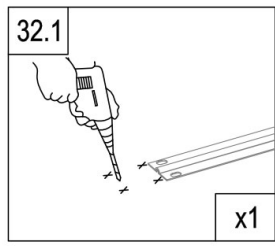
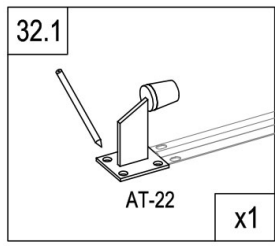
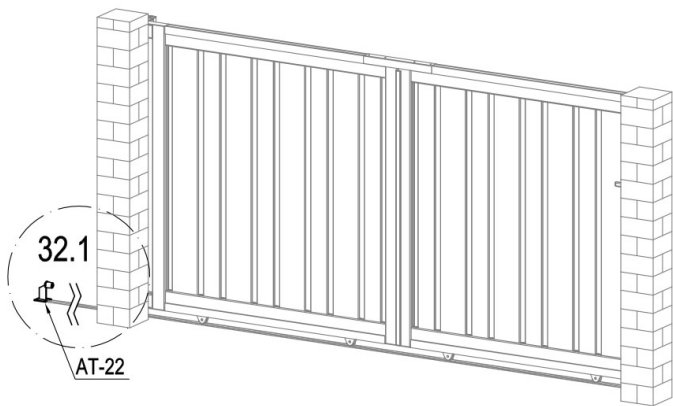

R



	AT-22	1
	RA-CB31	4
	AT-22J	4

