

# CASANOVO

## CIMONE 350C160

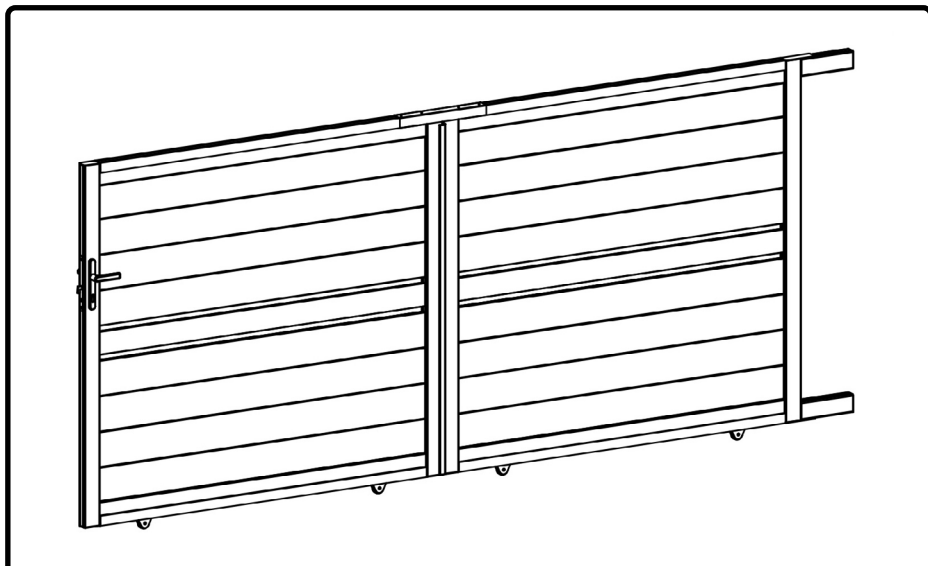

COM-001202 [x1]

COM-001203 [x1]

COM-001204 [x1]



6-7H



X 2



INSTRUCTION MANUAL / NOTICE DE MONTAGE / MONTAGEANLEITUNG / MANUAL DE MONTAJE / MANUAL DE MONTAGEM / MANUALE DI MONTAGGIO /  
MONTAGEHANDLEIDING / INSTRUKCJA MONTAŻU / KÄYTTÖOHJEET / BRUKSANVISNING / BRUGSANVISNING / INSTRUCȚIUNI DE ASAMBLARE /  
NAVODILA ZA SESTAVLJANJE / NÁVOD NA MONTÁŽ / ÖSSZESZERELÉSI ÚTMUTATÓ / NÁVOD K MONTÁŽI / UPUTE ZA INSTALACIJU /  
ΟΔΗΓΙΕΣ ΣΥΝΑΡΜΟΛΟΓΗΣΗΣ / SURINKIMO INSTRUKCIJOS / MONTĀŽAS INSTRUKCIJAS

**Ext.**

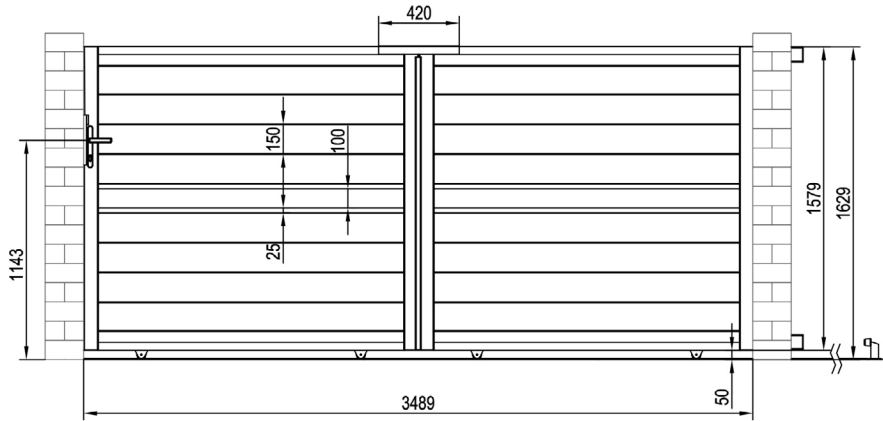

**Int.**

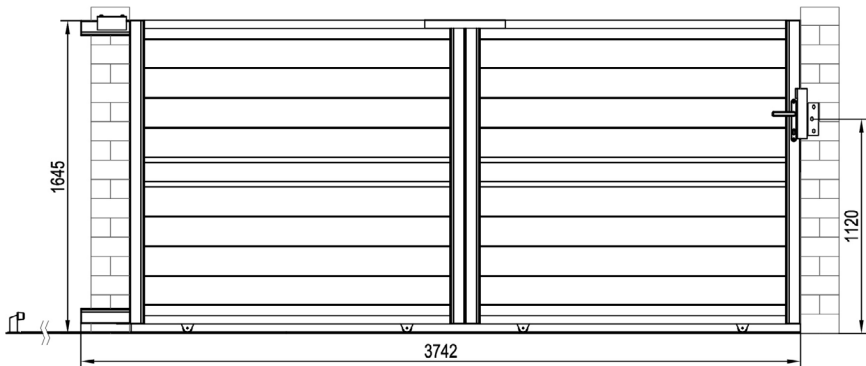

# CASANOVO

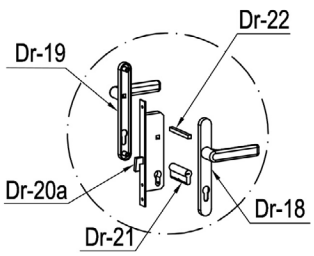
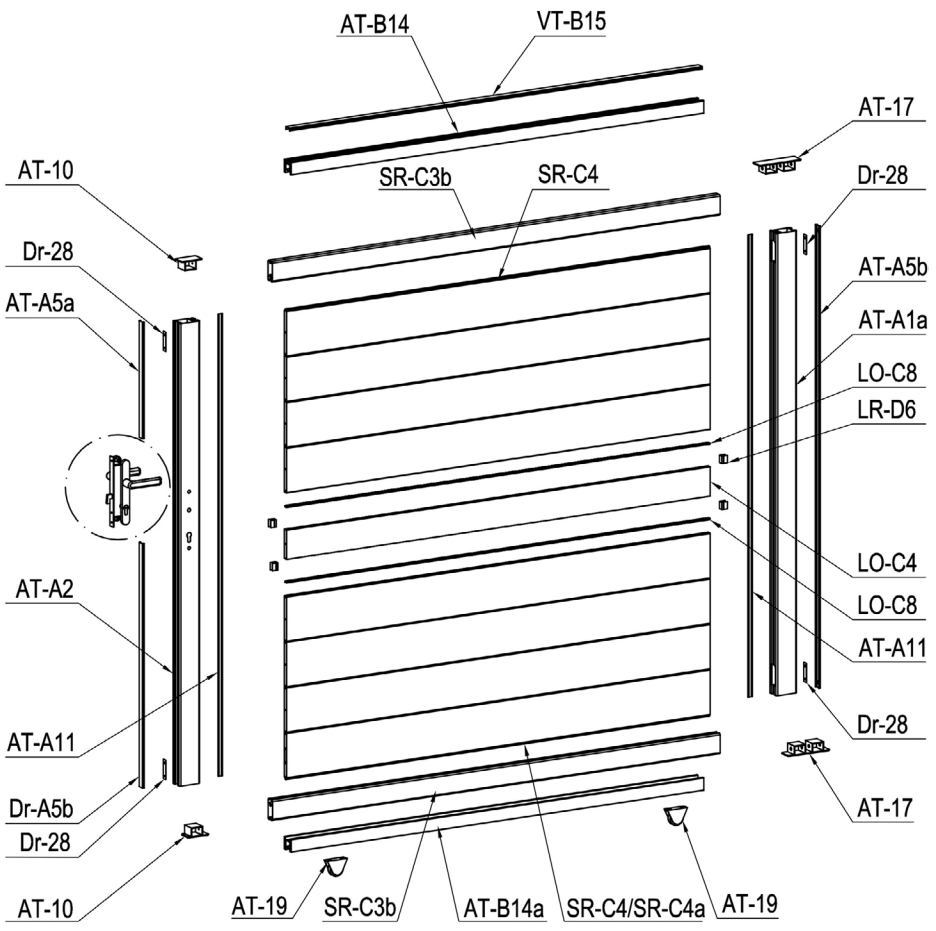



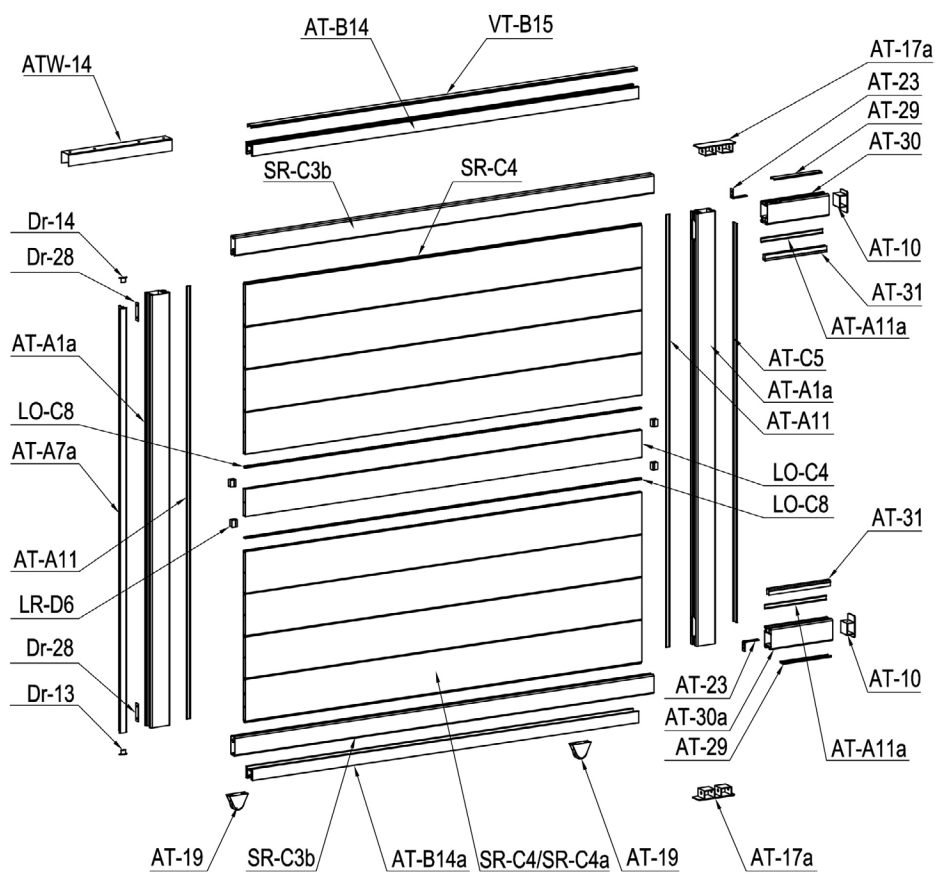

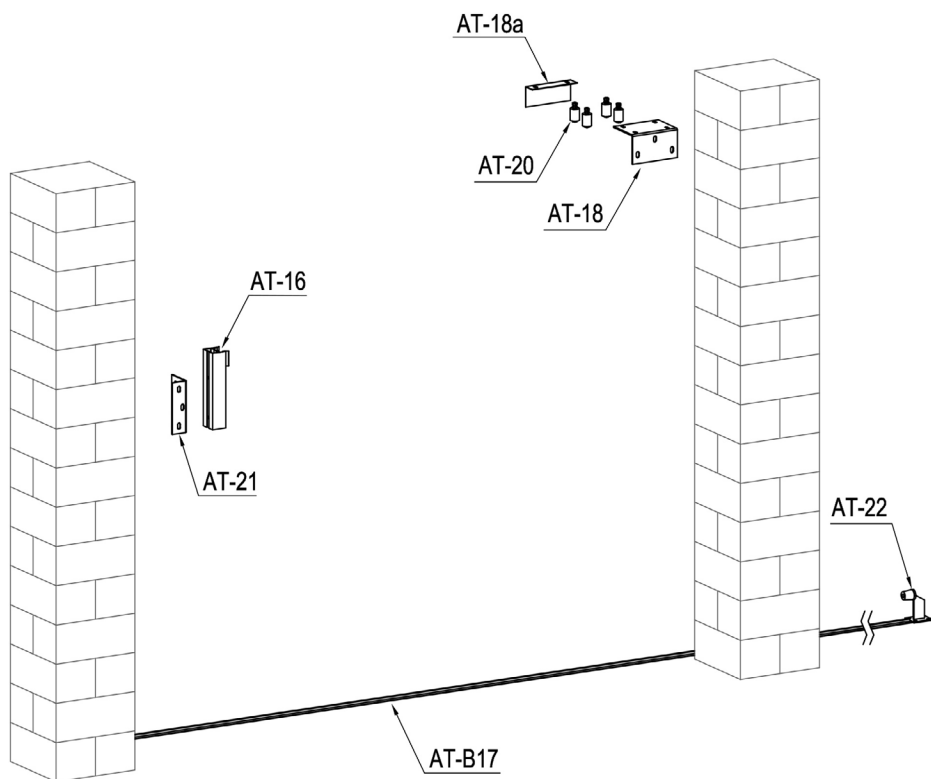









































# CASANOVO







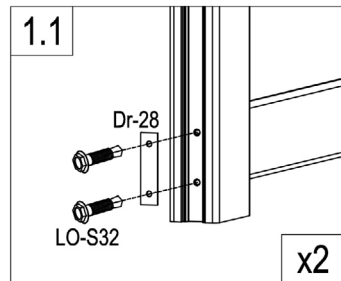
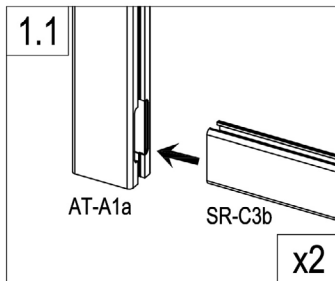
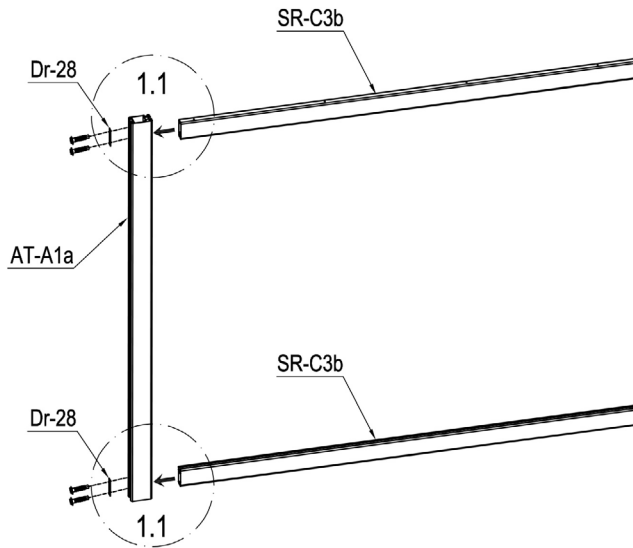

# CASANOVO

IMAGE	NO.	L.(mm)	QTY	IMAGE	NO.	L.(mm)	QTY
	AT-A1a	1573	3		Dr-14		1
	AT-A2	1573	1		AT-18		1
	AT-30	250	1		AT-18a		1
	AT-30a	250	1		ATW-14	420	1
	SR-C3b	1721	4		AT-19		4
	SR-C4a	1630	2		AT-20		4
	SR-C4	1630	14		AT-21		1
	LO-C4	1630	2		AT-22		1
	AT-A5b	1573	1		AT-23		2
	AT-C5	1448	1		Dr-18		1
	AT-A5a	395.5	1		Dr-19		1
	Dr-A5b	937	1		Dr-20a		1
	AT-29	193	2		Dr-21		1
	AT-A11	1573	4		Dr-22		1
	AT-A11a	250	2		Dr-25		1
	AT-31	250	2		Dr-25a		2
	LR-D6	25	8		Dr-27		2
	LO-C8	1629	4		Dr-28		6
	AT-A7a	1520	1		AT-22J		7
	AT-B14	1588	2		LO-S30	ST4x10	4
	AT-B14a	1588	2		LO-S31	M8x60	10
	VT-B15	1587	2		LO-S32	ST5.5x38	32
	AT-16	260	1		LO-S33	M8x130	4
	AT-B17	1412	5		LO-S34	ST4.8x38	72
	AT-17		2		LO-S35	ST4.2x19	6
	AT-17a		2		LO-S36	M6x20	2
	AT-10		4		LO-S37	M8x20	8
	Dr-13		1		LO-S38	ST4x25	50



	AT-A1a	1
	SR-C3b	2
	Dr-28	2
	LO-S32	4

# CASANOVO

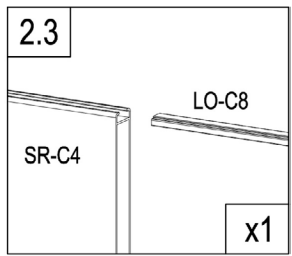
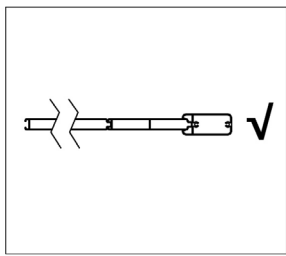
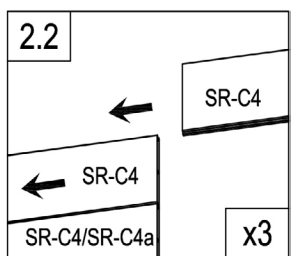
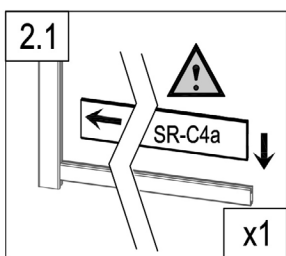
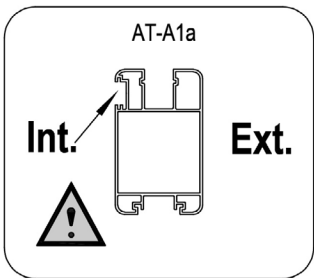
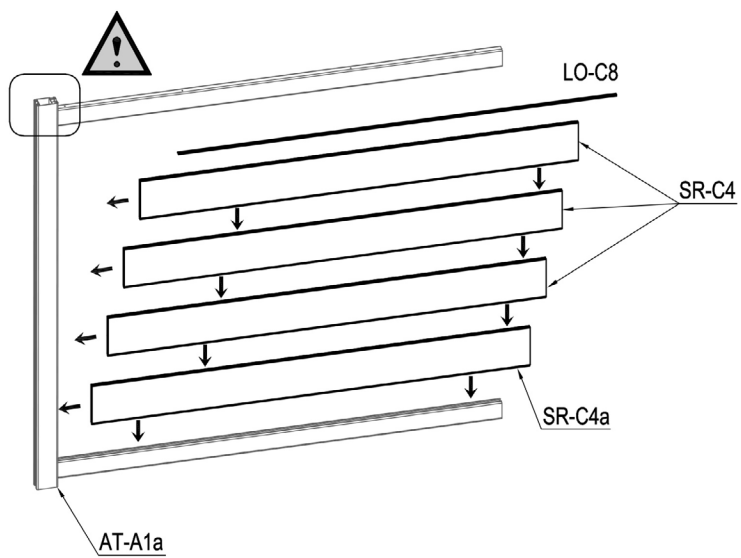

	LO-C8	1
	SR-C4	3
	SR-C4a	1



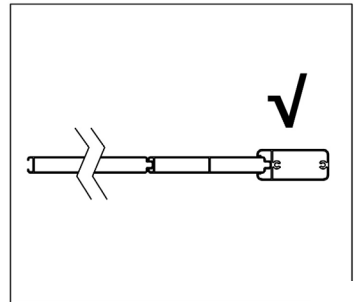
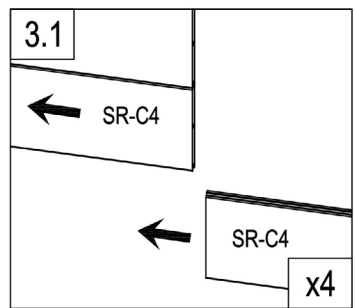
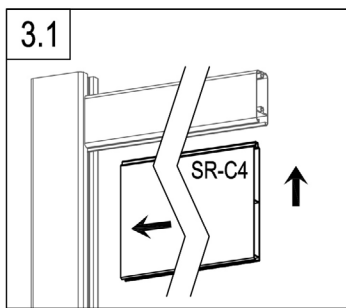
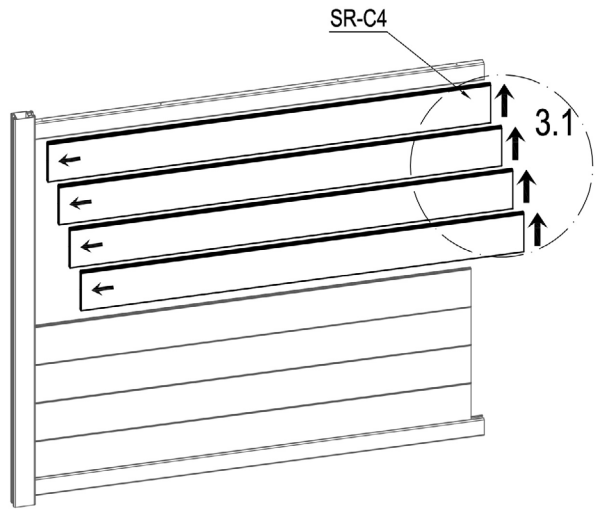

# CASANOVA



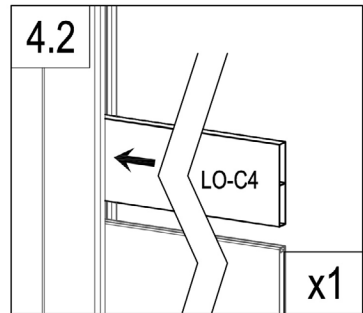
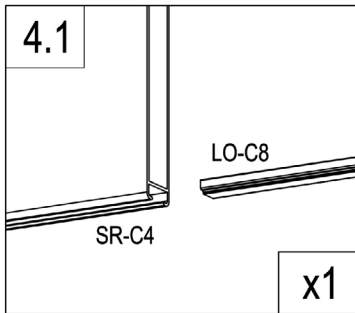
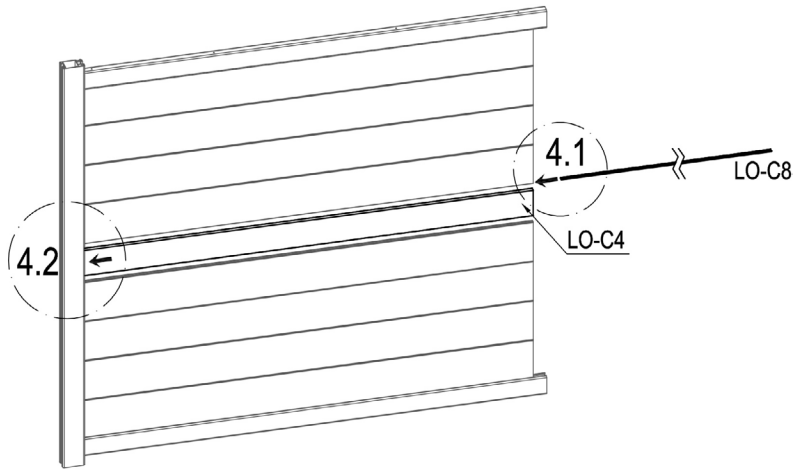

	SR-C4	4
---	-------	---

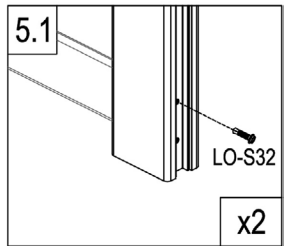
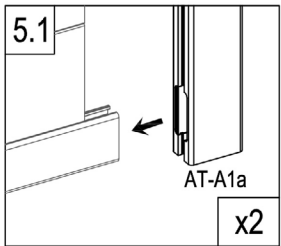
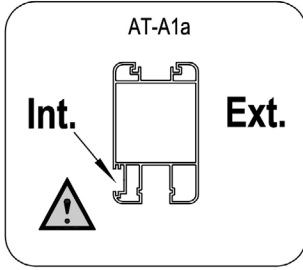
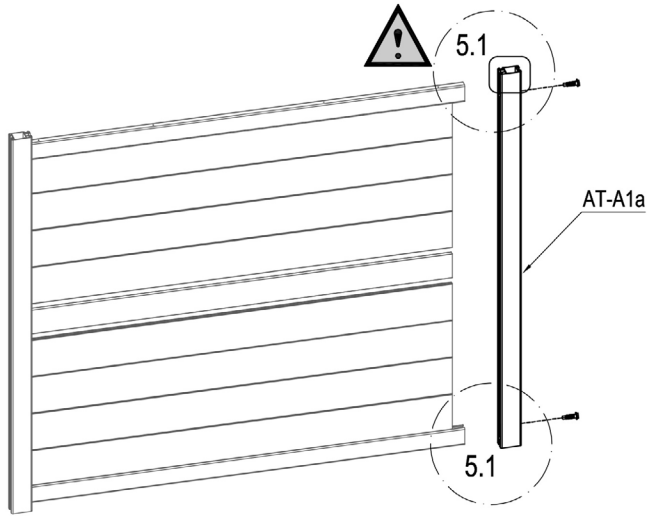

	LO-C4	1
	LO-C8	1



	AT-A1a	1
	LO-S32	2

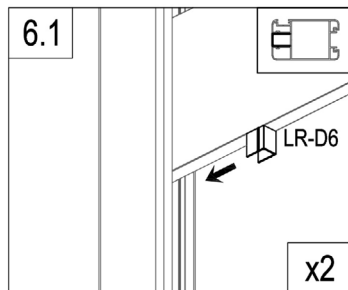
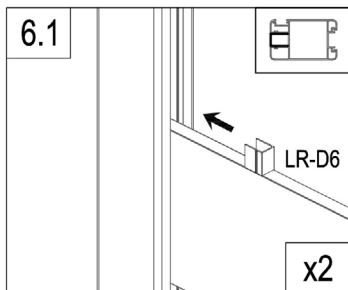
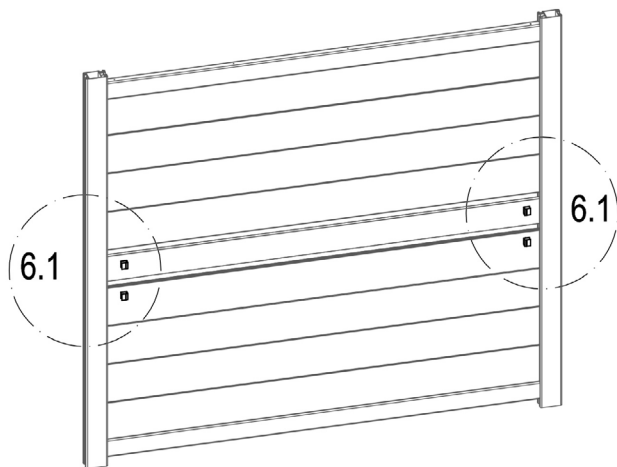

	LR-D6	4
---	-------	---

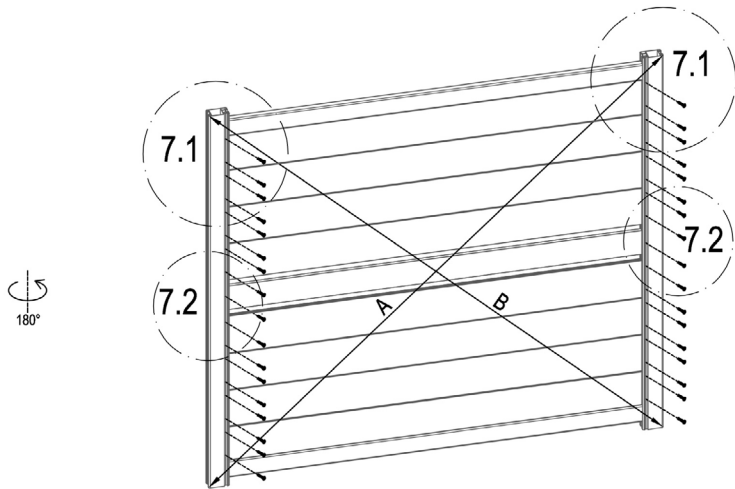

A=B

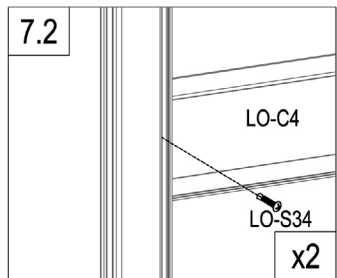
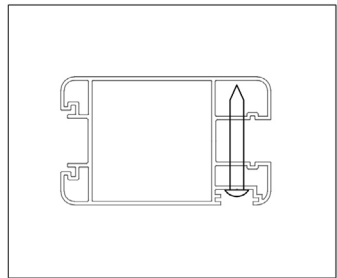
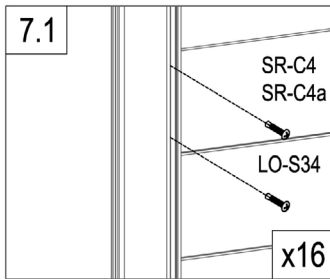



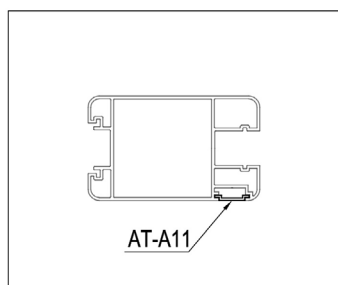
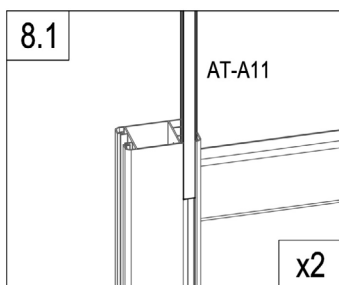
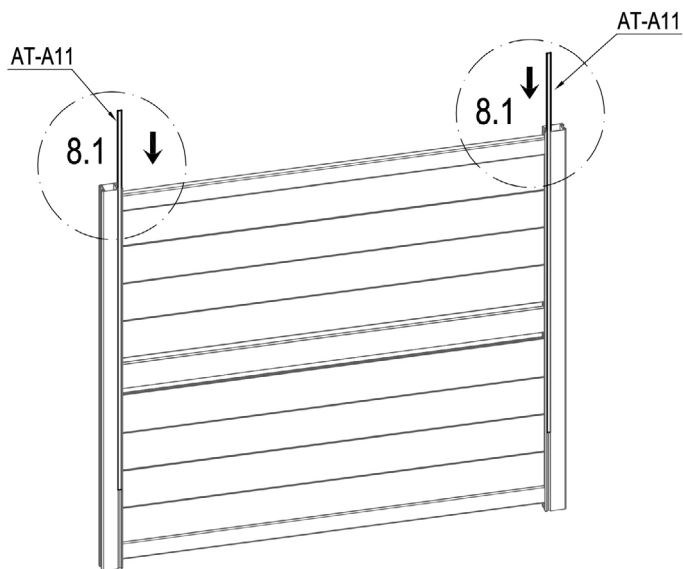

	LO-S34	34
---	--------	----

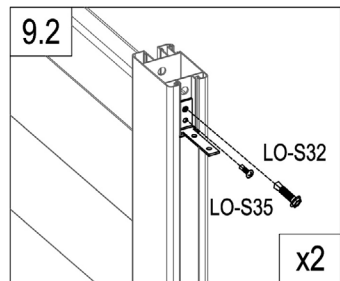
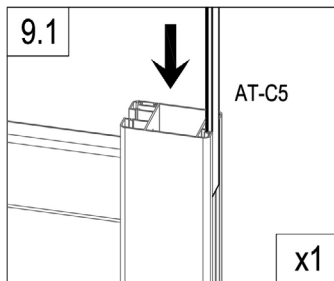
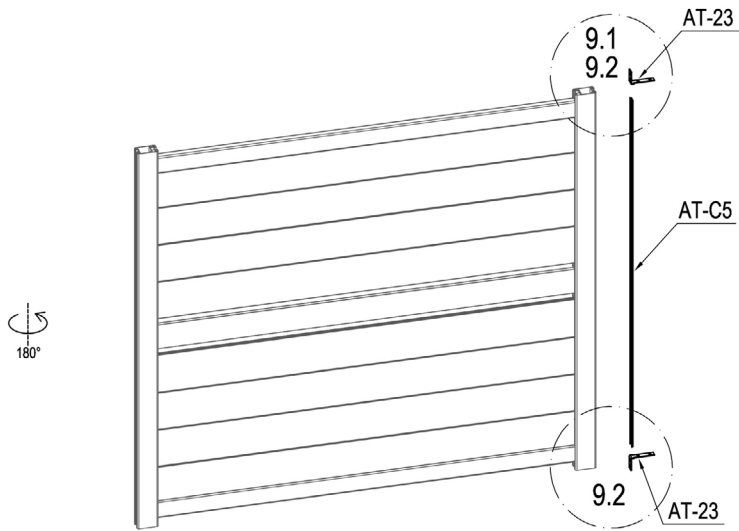





	AT-A11	2
---	--------	---

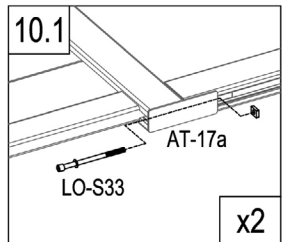
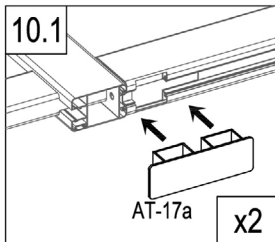
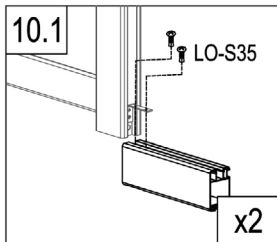
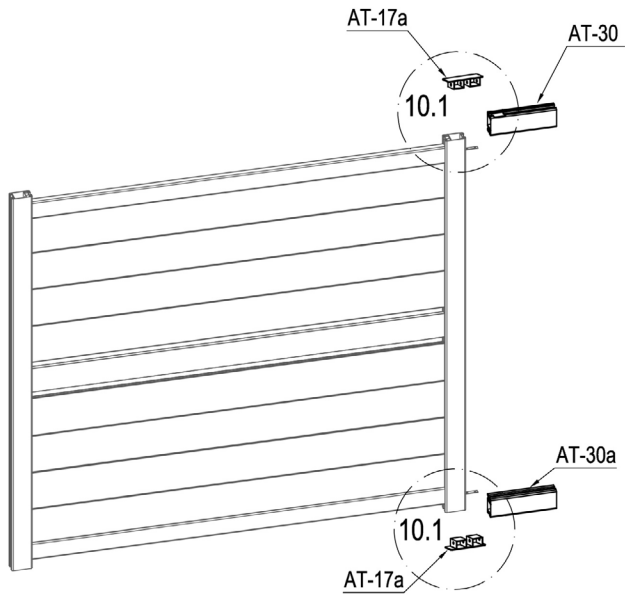

	AT-C5	1
	AT-23	2
	LO-S32	2
	LO-S35	2



	AT-30	1
	AT-30a	1
	AT-17a	2

	LO-S33	2
	LO-S35	4



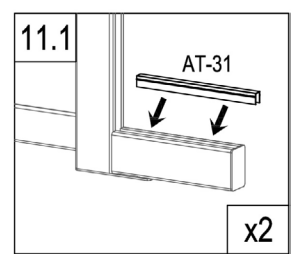
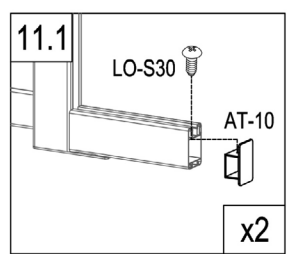
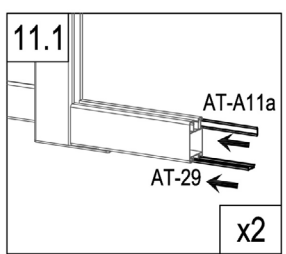
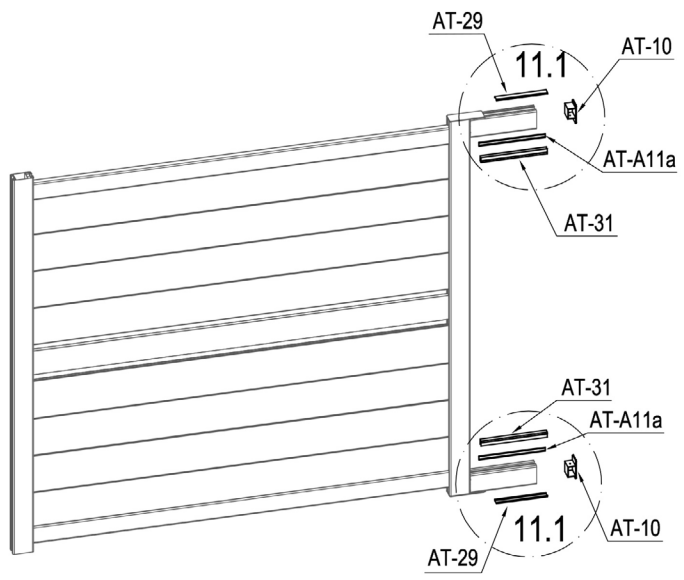





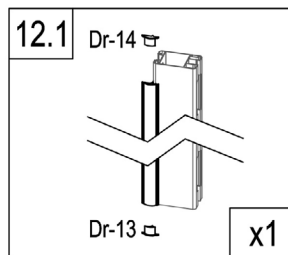
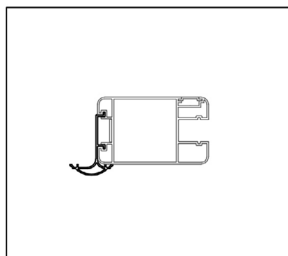
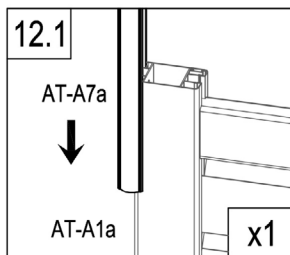
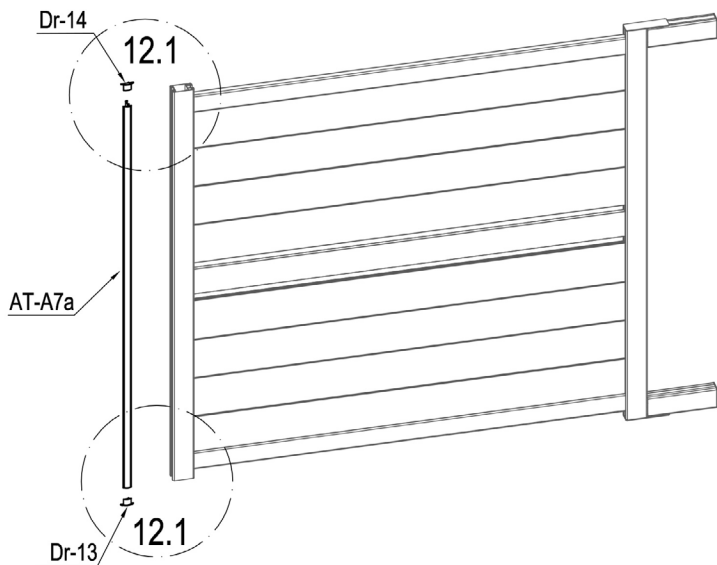

	AT-29	2
	AT-A11a	2
	AT-31	2

	AT-10	2
	LO-S30	2

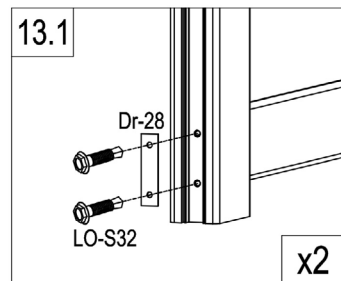
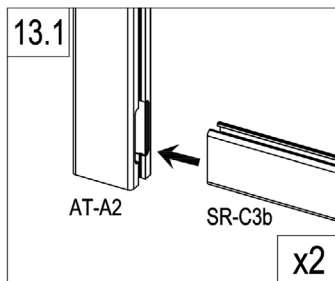
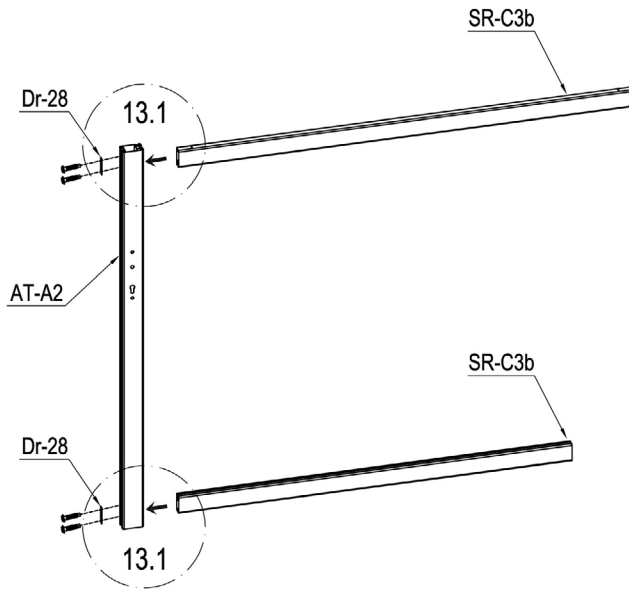

	AT-A7a	1
	Dr-13	1
	Dr-14	1



	AT-A2	1
	SR-C3b	2
	Dr-28	2
	LO-S32	4

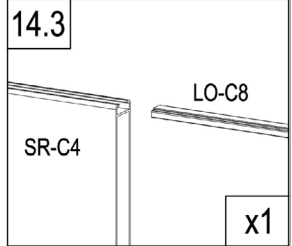
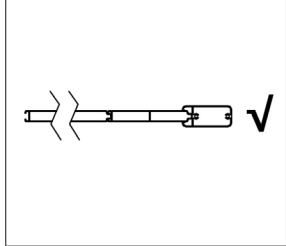
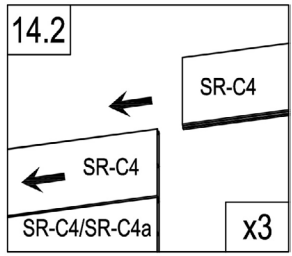
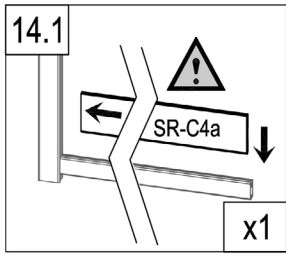
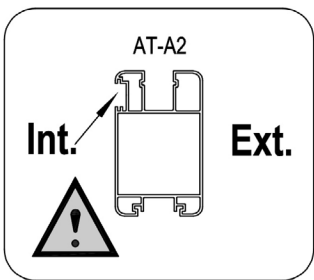
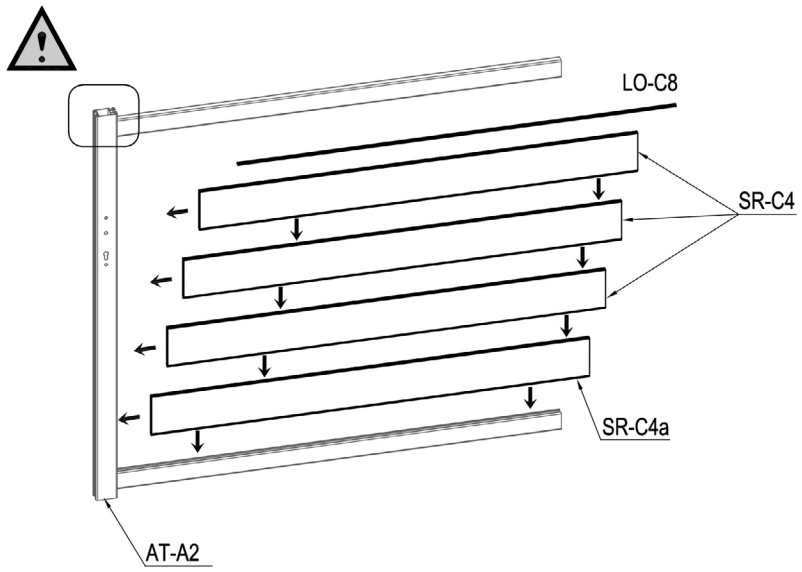

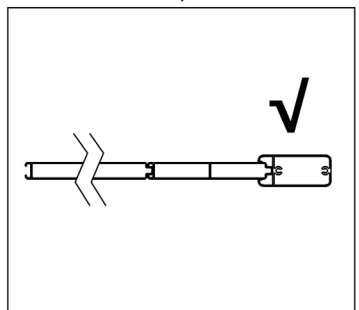
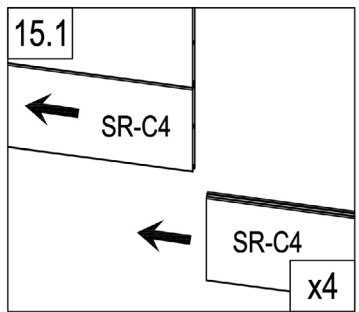
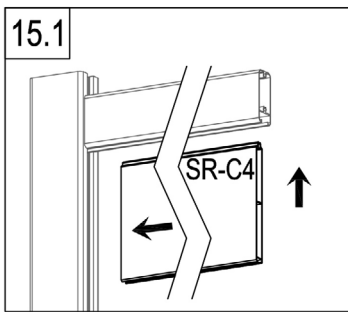
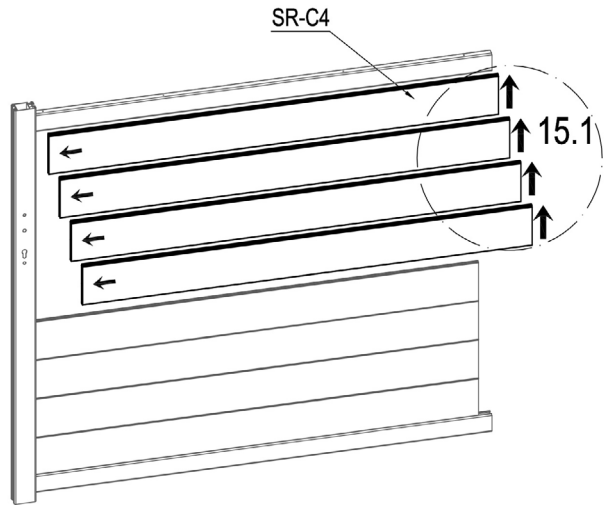

	LO-C8	1
	SR-C4	3
	SR-C4a	1



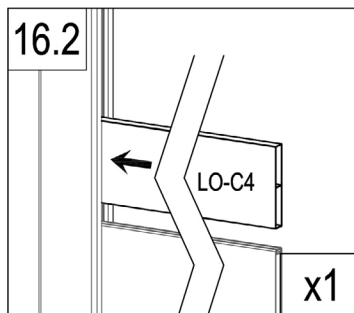
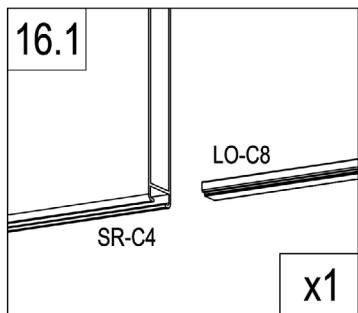
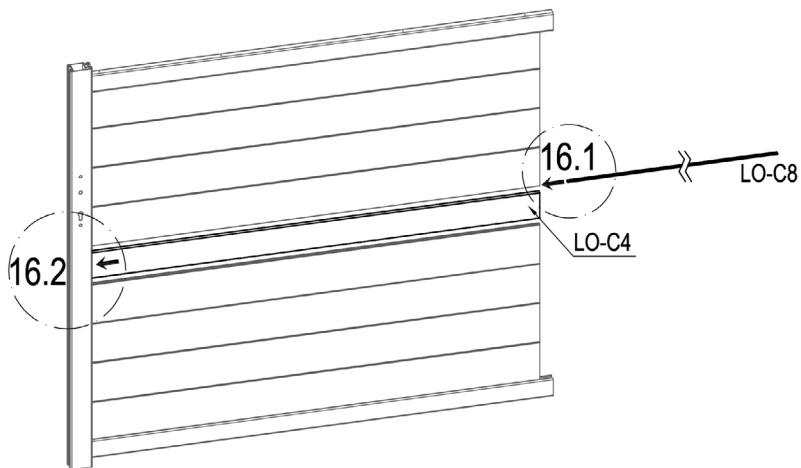

	SR-C4	4
---	-------	---

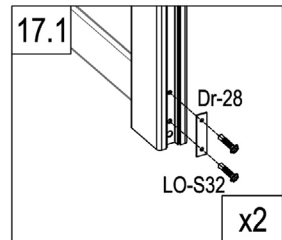
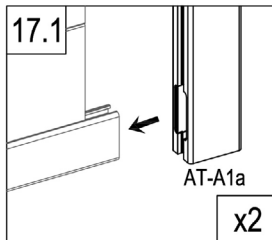
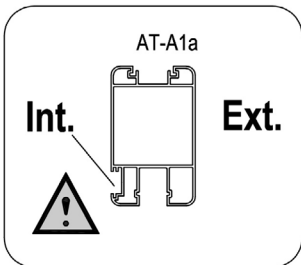
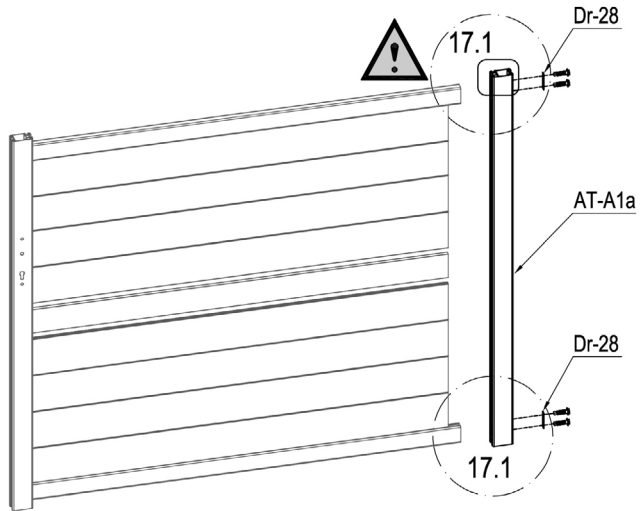

	LO-C4	1
	LO-C8	1



	AT-A1a	1
	Dr-28	2
	LO-S32	4

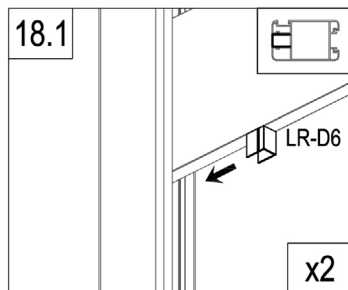
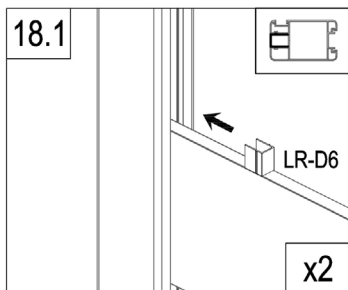
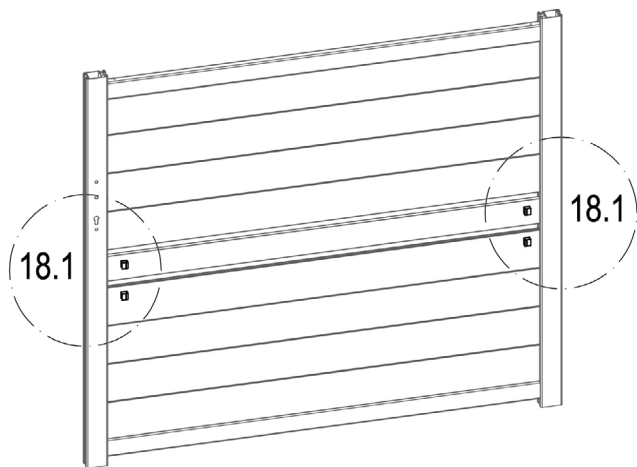



	LR-D6	4
---	-------	---

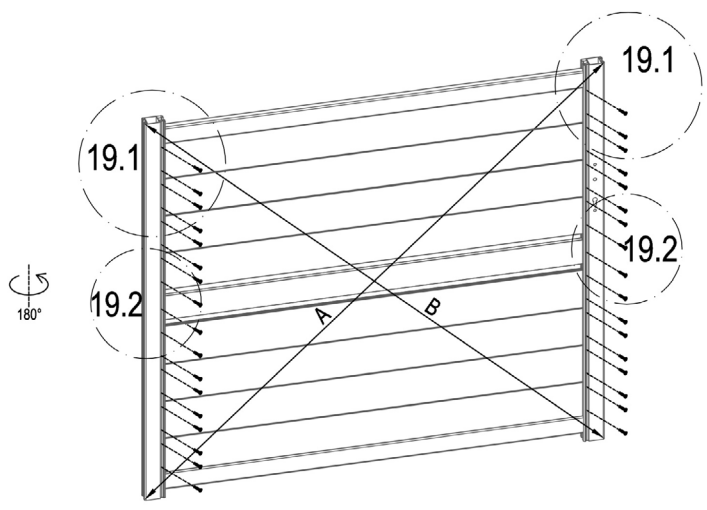



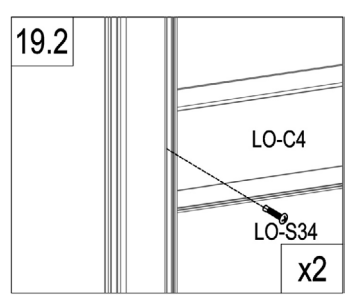
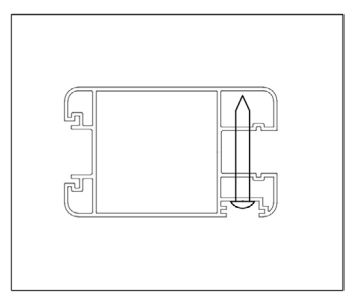
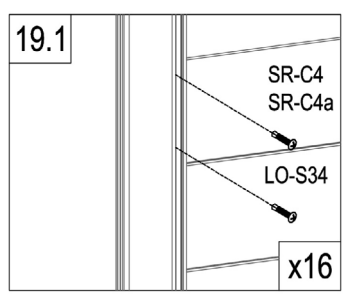

A=B

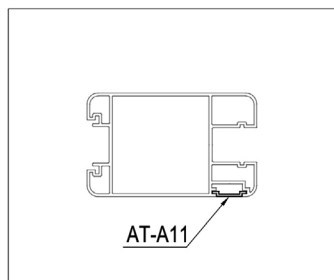
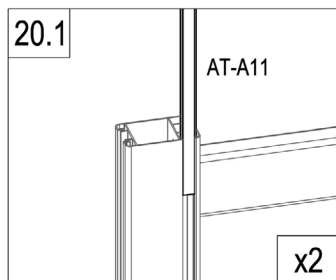
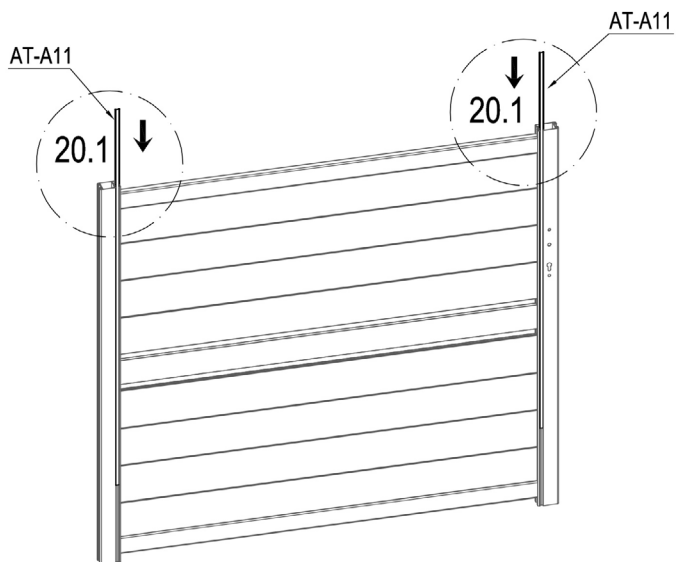

	LO-S34	34
---	--------	----



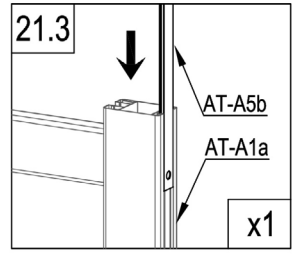
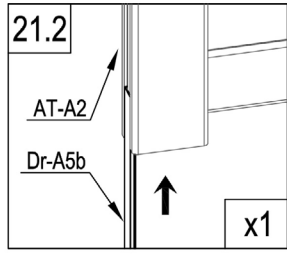
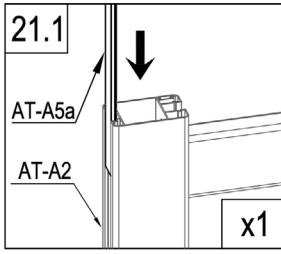
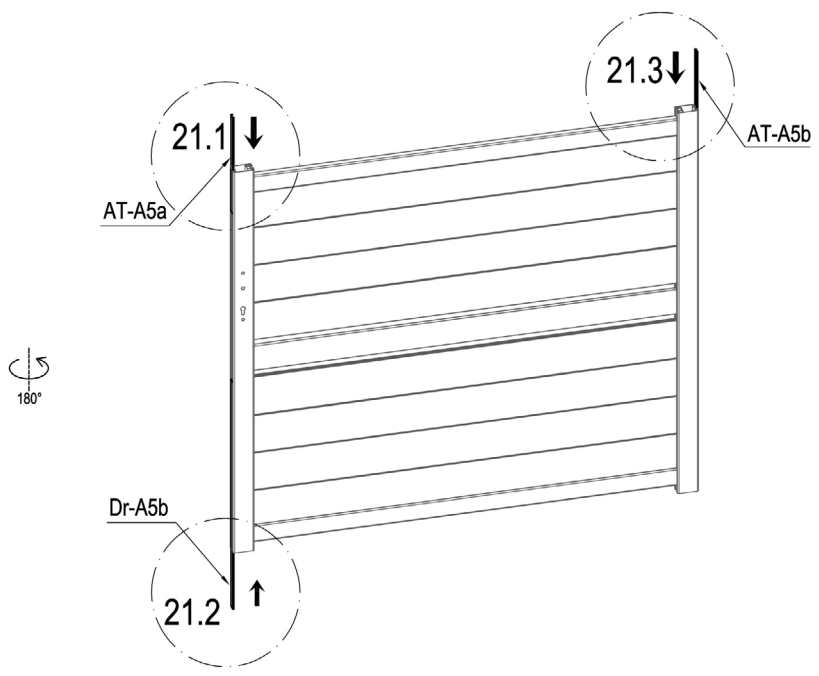

	AT-A11	2
---	--------	---

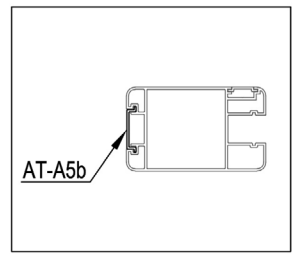

	AT-A5b	1
	AT-A5a	1
	Dr-A5b	1

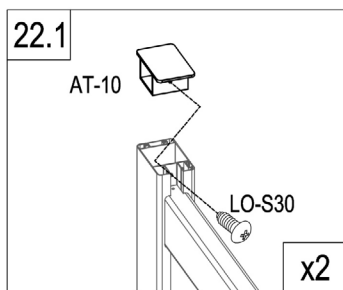
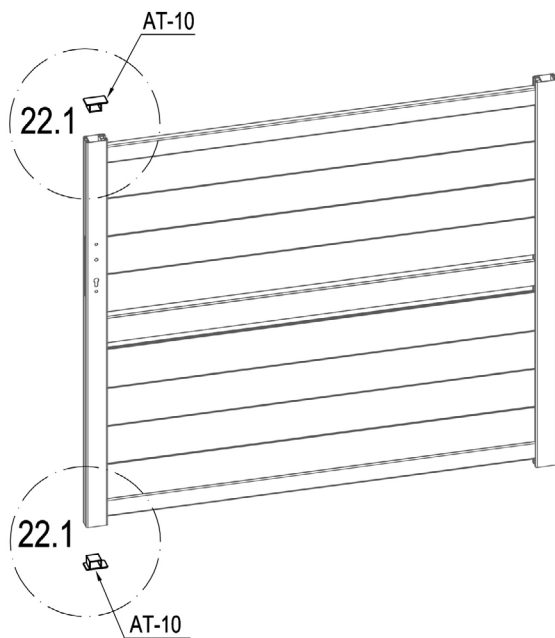



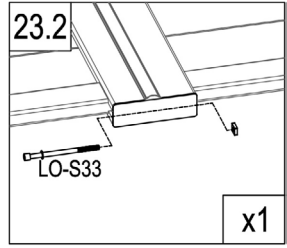
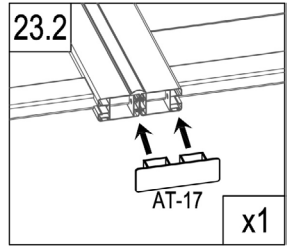
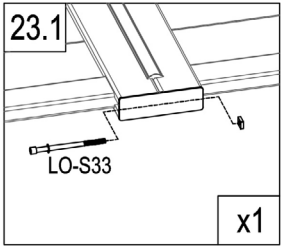
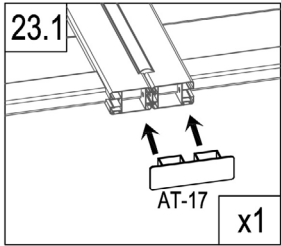
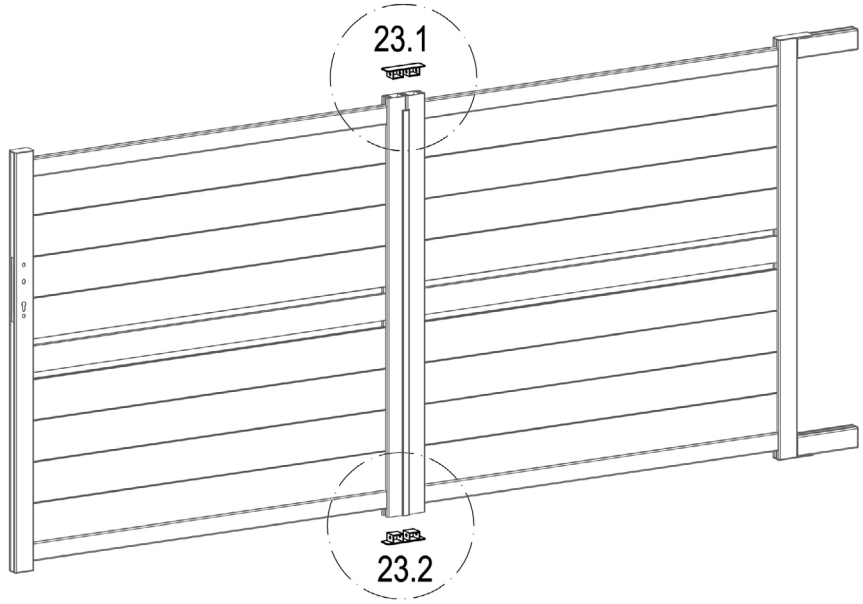

	AT-10	2
	LO-S30	2

# CASANOVA



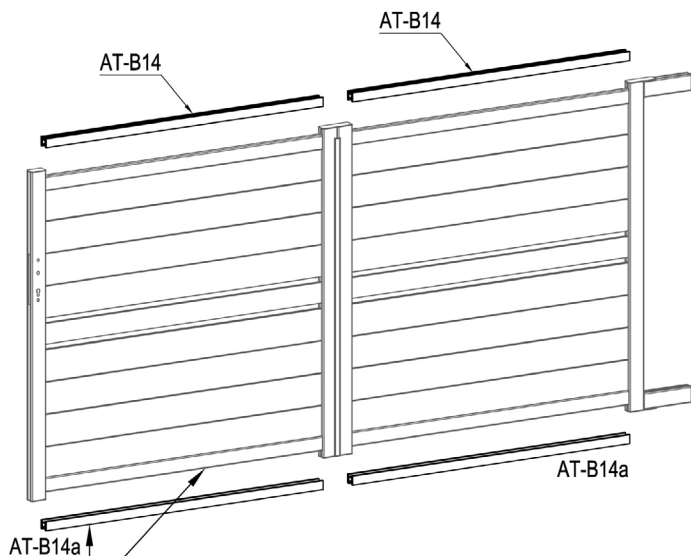

	AT-17	2
	LO-S33	2

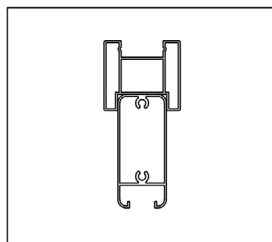
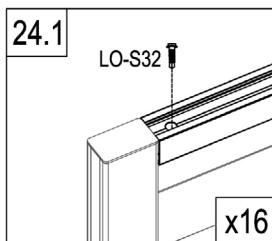
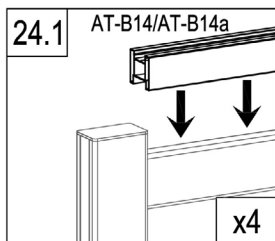

EN: These parts are made for connecting your gate's automation  
 FR: Ces pièces sont faites pour relier l'automatisation de votre portail  
 DE: Diese Teile sind für den Anschluss der Automatisierung Ihres Tores vorgesehen  
 ES: Estas piezas están hechas para conectar la automatización de su puerta  
 PT: Estas peças são feitas para ligar a automatização do seu portão  
 IT: Queste parti sono realizzate per collegare l'automazione del vostro cancello  
 NL: Deze onderdelen zijn gemaakt voor het aansluiten van de automatisering van uw poort.  
 PL: Te części są wykonane do podłączenia automatyki bramy.



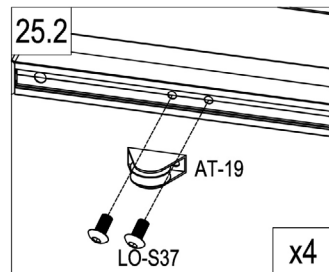
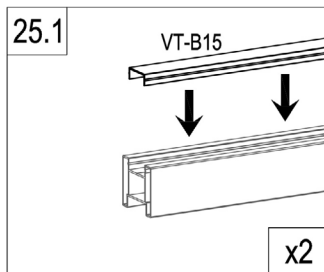
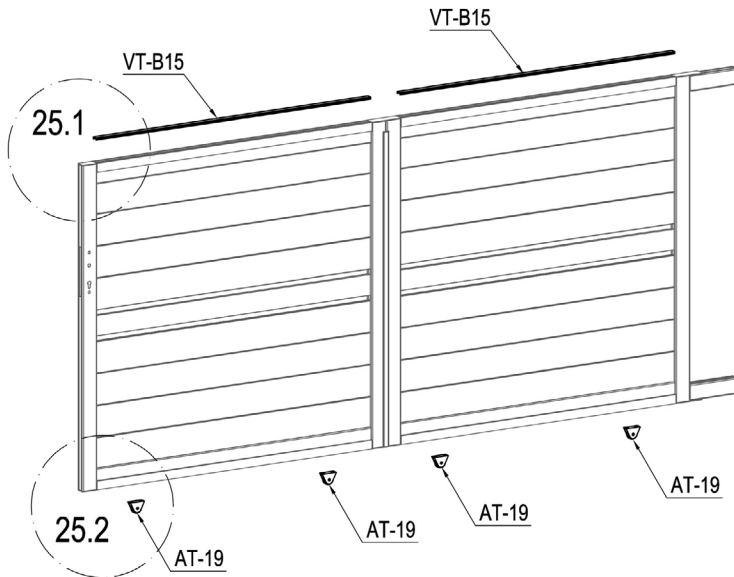

	AT-B14	2
	AT-B14a	2
	LO-S32	16

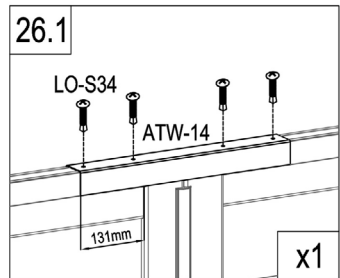
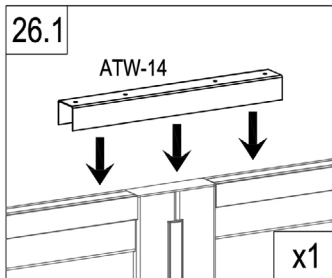
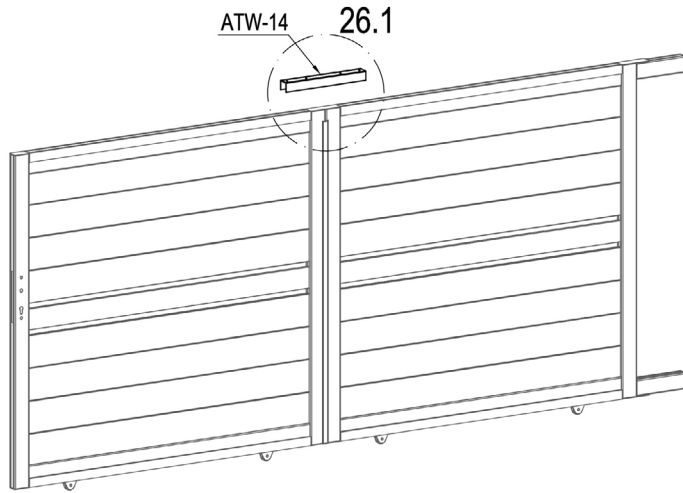

	VT-B15	2
	AT-19	4
	LO-S37	8



	ATW-14	1
	LO-S34	4



# CASANOVO

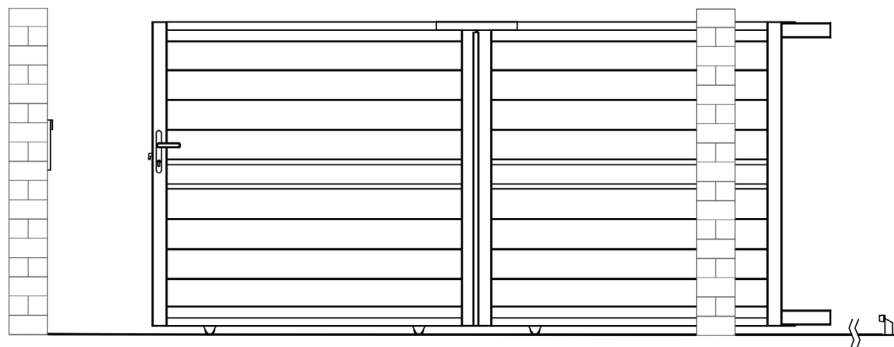

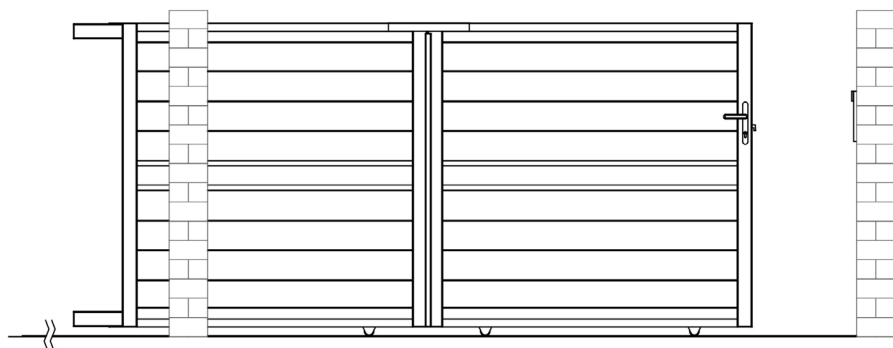

L

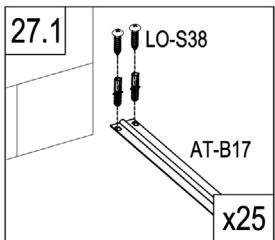
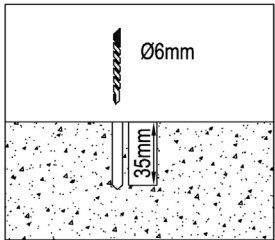
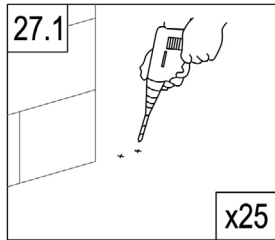
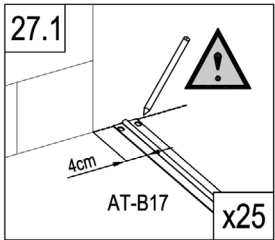
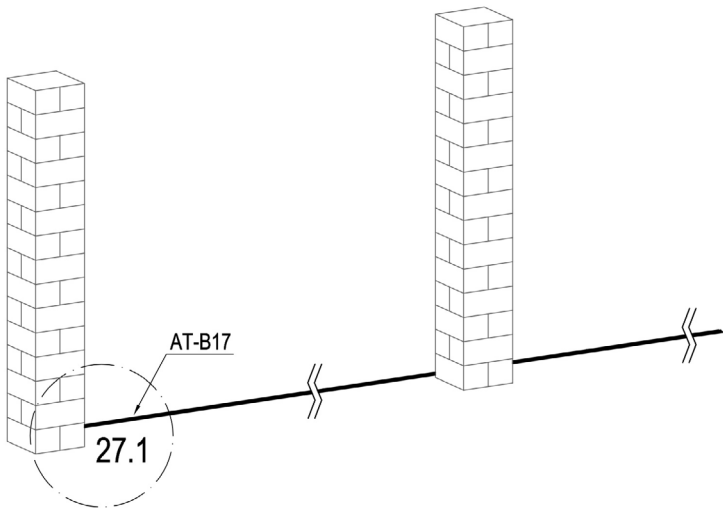

R

L



	AT-B17	5
	LO-S38	50

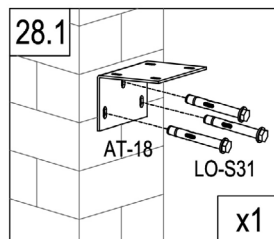
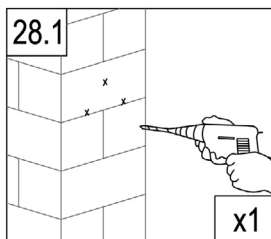
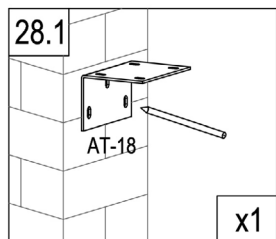
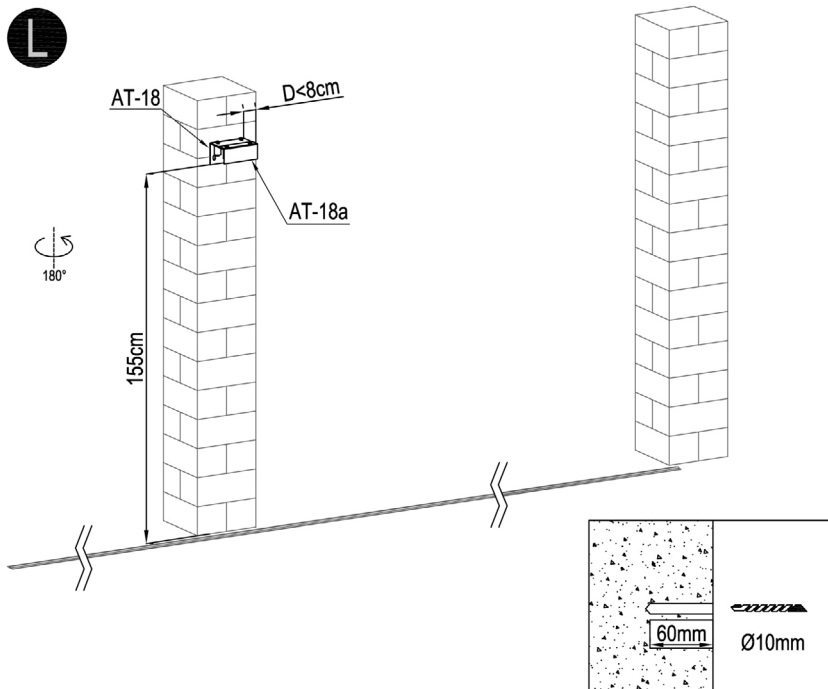

	AT-18	1
	AT-18a	1
	AT-20	4
	LO-S31	3

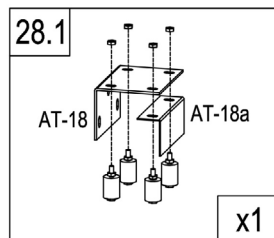
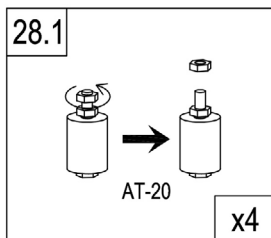

L

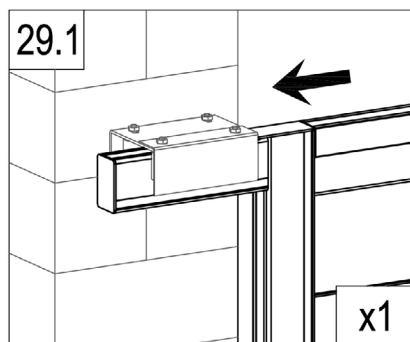
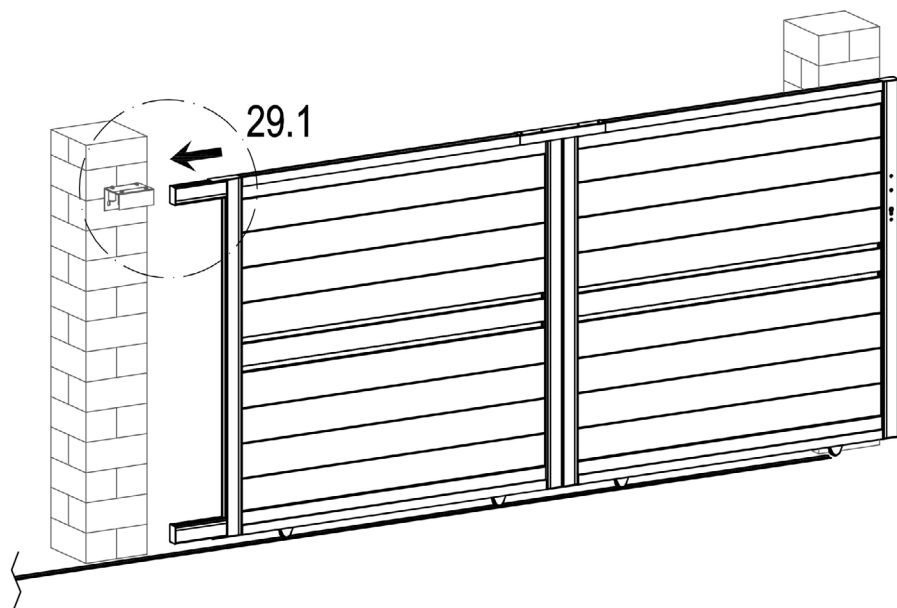

L

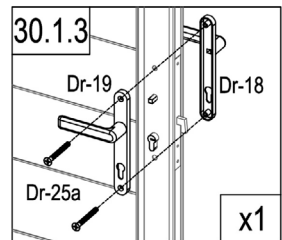
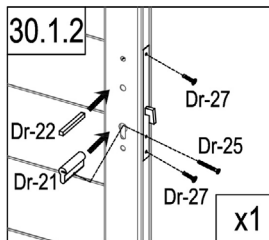
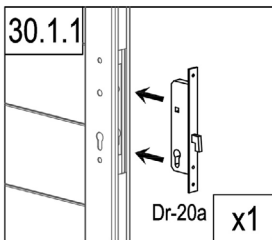
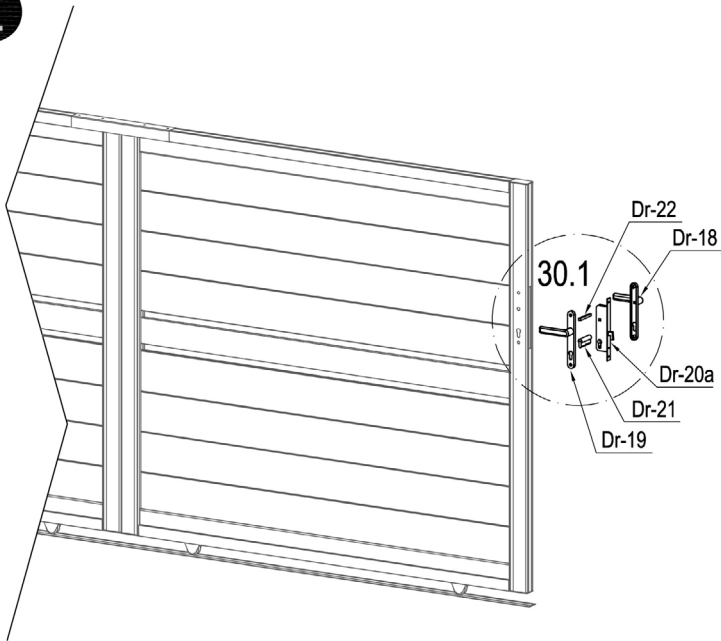

	Dr-20a	1
	Dr-21	1
	Dr-22	1
	Dr-25	1

	Dr-18	1
	Dr-19	1
	Dr-25a	2
	Dr-27	2

L

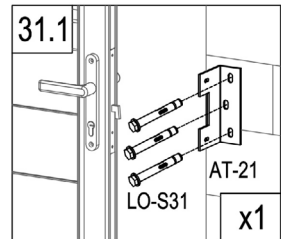
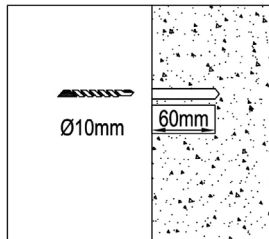
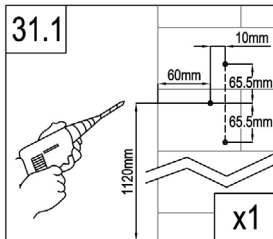
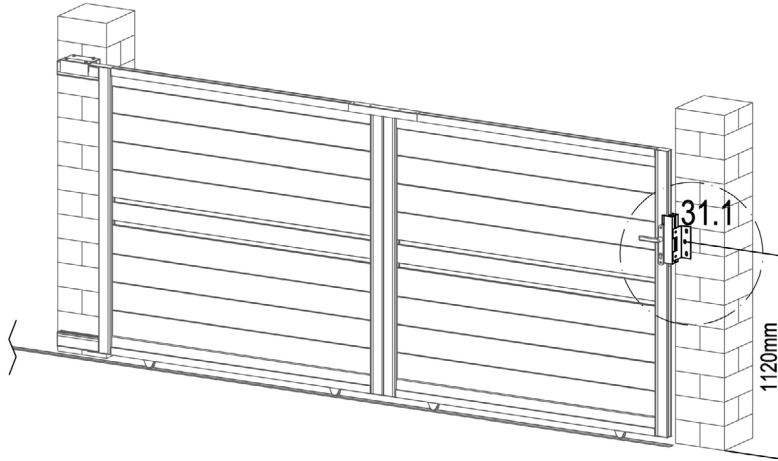

	AT-16	1
	AT-21	1
	LO-S36	2
	LO-S31	3
	AT-22J	3

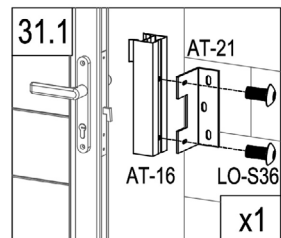
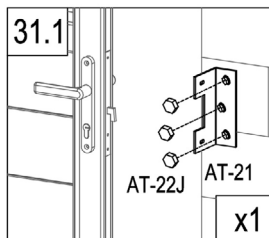

L

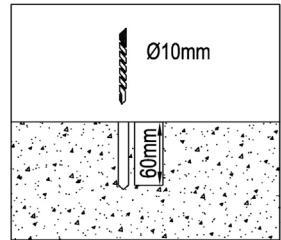
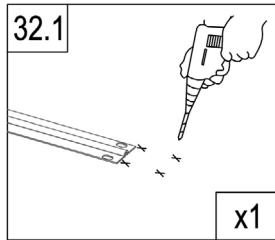
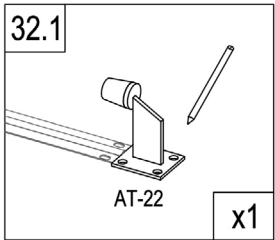
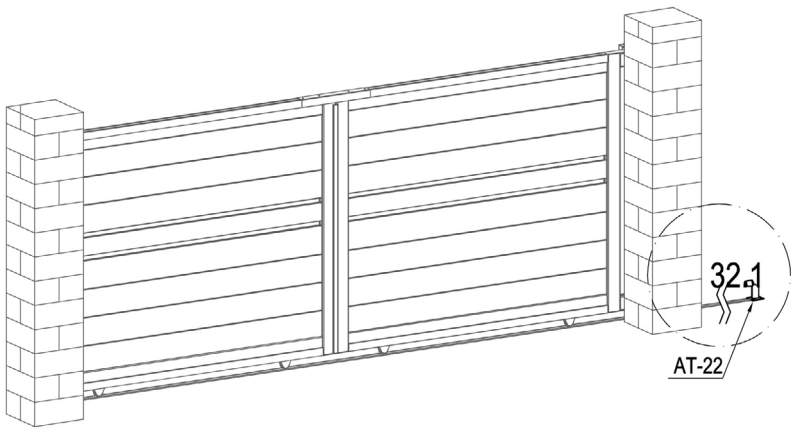

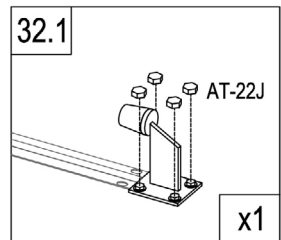
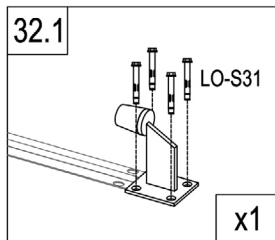

	AT-22	1
	LO-S31	4
	AT-22J	4

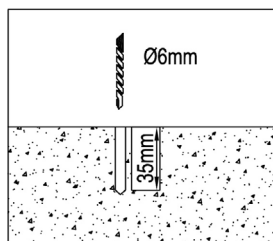
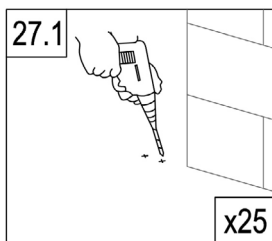
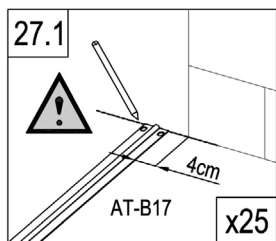
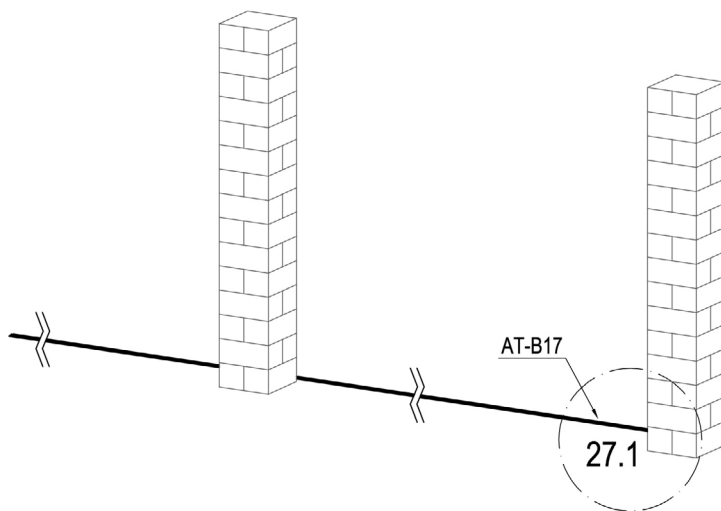

R



	AT-B17	5
	LO-S38	50

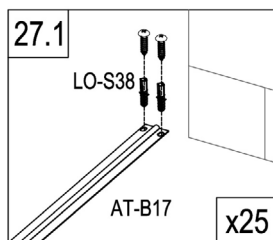



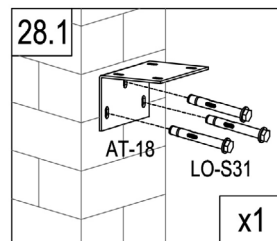
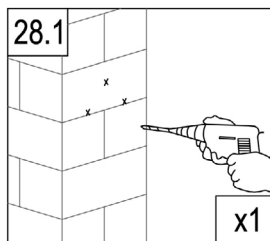
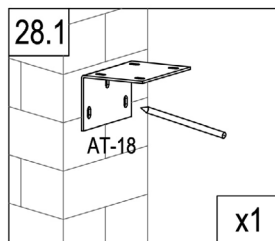
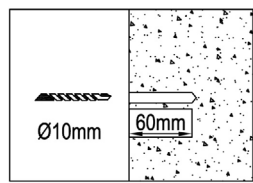
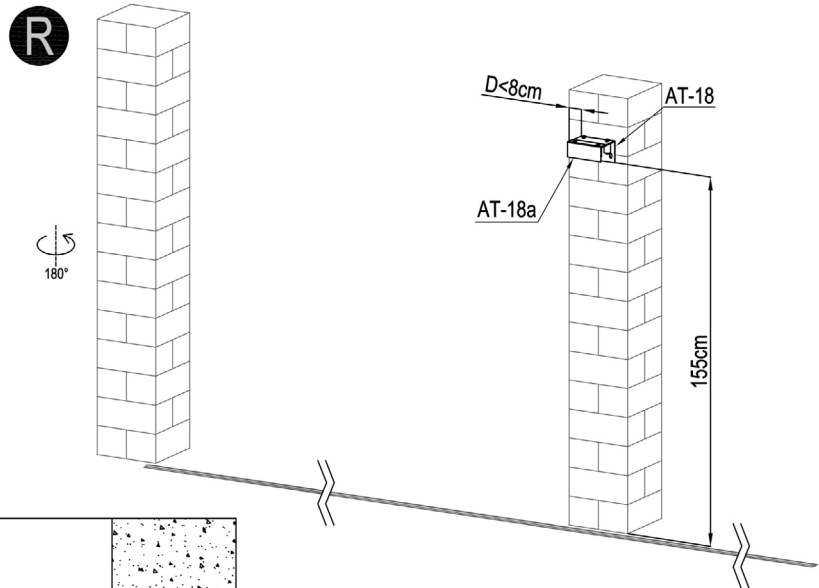

	AT-18	1
	AT-18a	1
	AT-20	4
	LO-S31	3

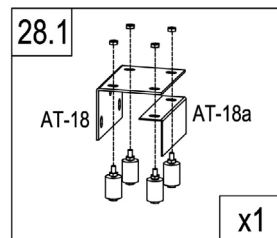
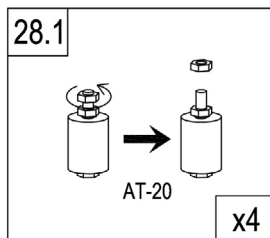

R

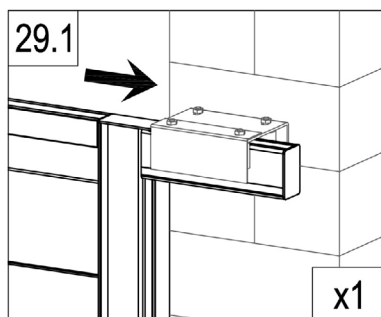
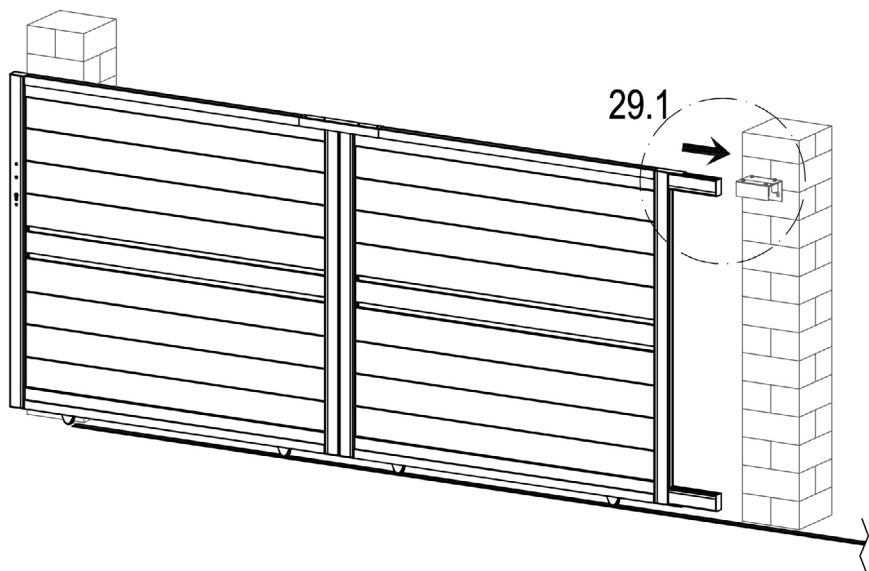

R

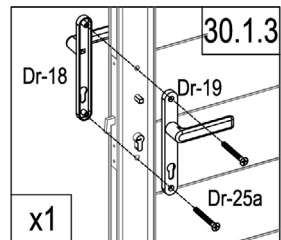
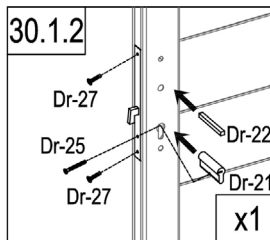
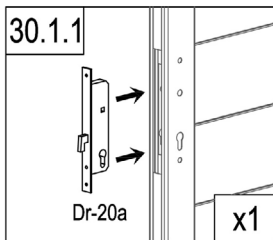
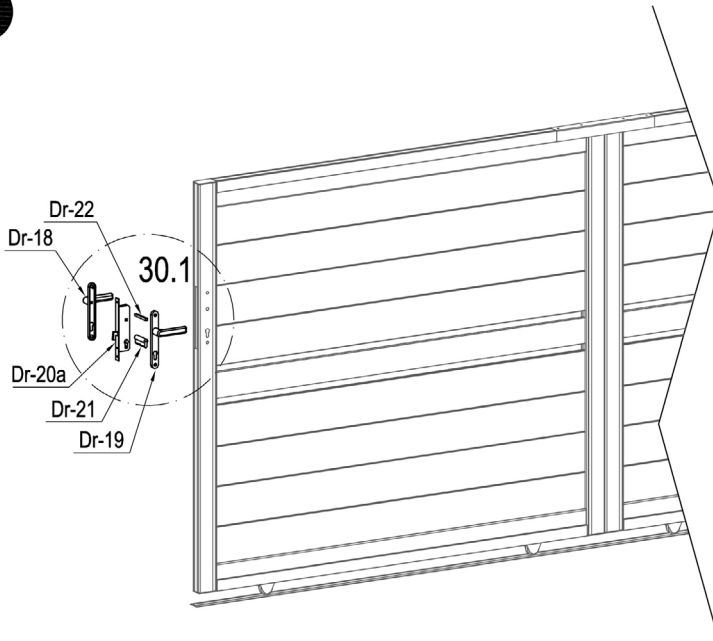

	Dr-20a	1
	Dr-21	1
	Dr-22	1
	Dr-25	1

	Dr-18	1
	Dr-19	1
	Dr-25a	2
	Dr-27	2

R

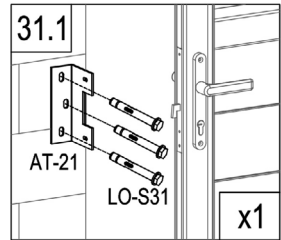
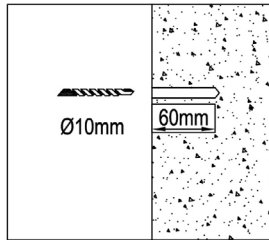
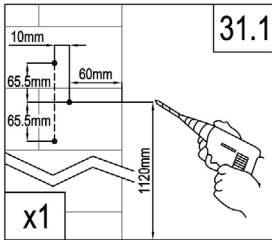
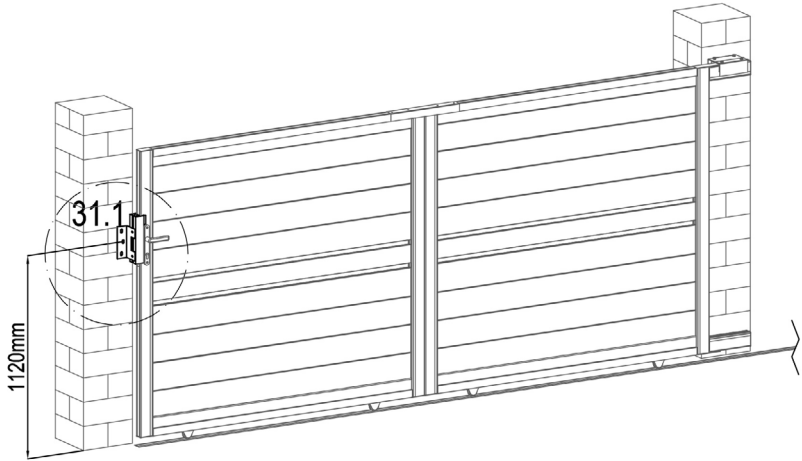

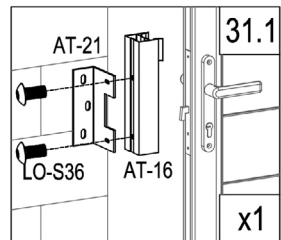
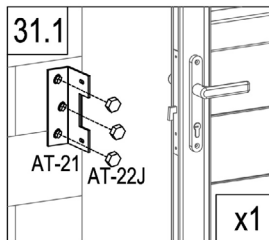

	AT-16	1
	AT-21	1
	LO-S36	2
	LO-S31	3
	AT-22J	3

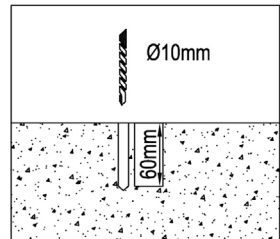
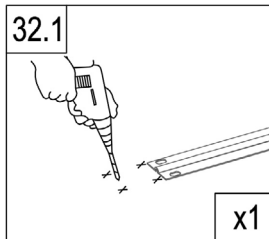
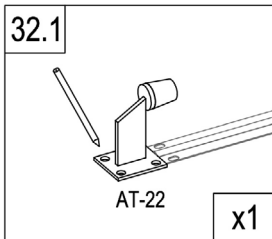
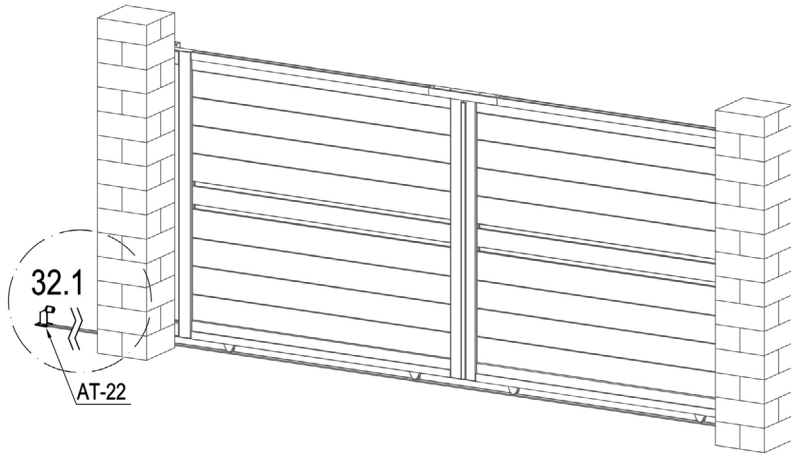

R



	AT-22	1
	LO-S31	4
	AT-22J	4

