

kleanfin

IN220901186V02_GL

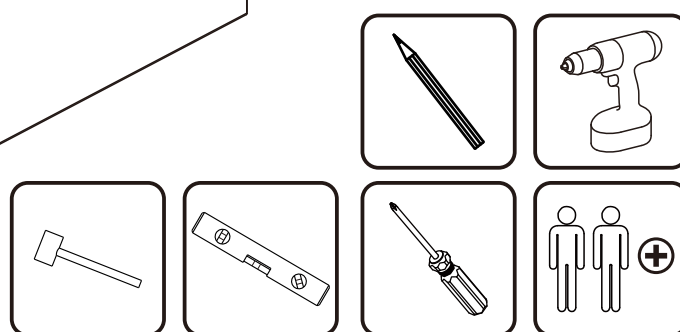
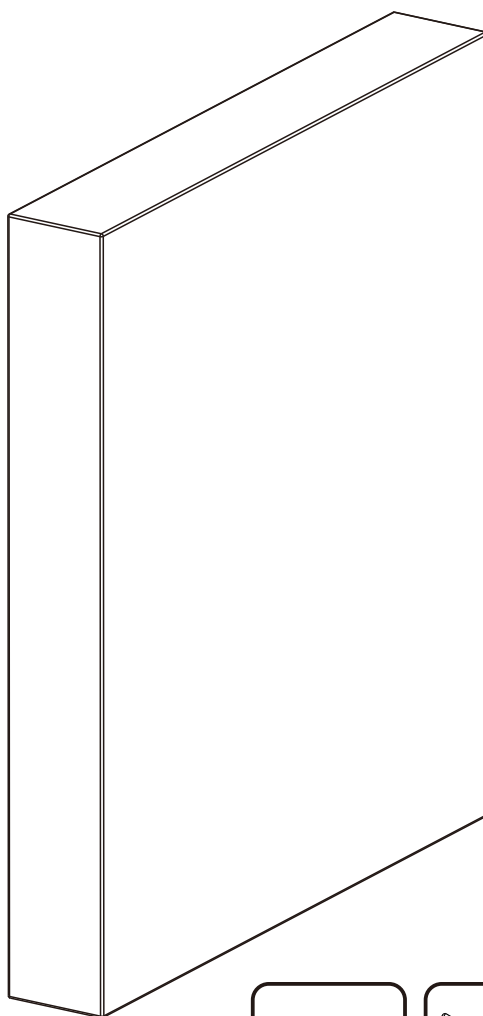

Tools Recommended

EN_ IMPORTANT, RETAIN FOR FUTURE REFERENCE: READ CAREFULLY.

FR_ IMPORTANT: A LIRE ATTENTIVEMENT ET À CONSERVER POUR CONSULTATION ULTÉRIEURE.

ES_ IMPORTANTE, LEA Y GUARDE PARA FUTURAS REFERENCIAS.

PT_ IMPORTANTE, REter PARA REFERÊNCIA FUTURA: LEIA ATENTAMENTE.

DE_ WICHTIG! SORGFÄLTIG LESEN UND FÜR SPÄTER NACHSCHLAGEN AUFBEWAHREN.

IT_ IMPORTANTE! CONSERVARE IL PRESENTE MANUALE PER FUTURO RIFERIMENTO E LEGGERLO ATTENTAMENTE.

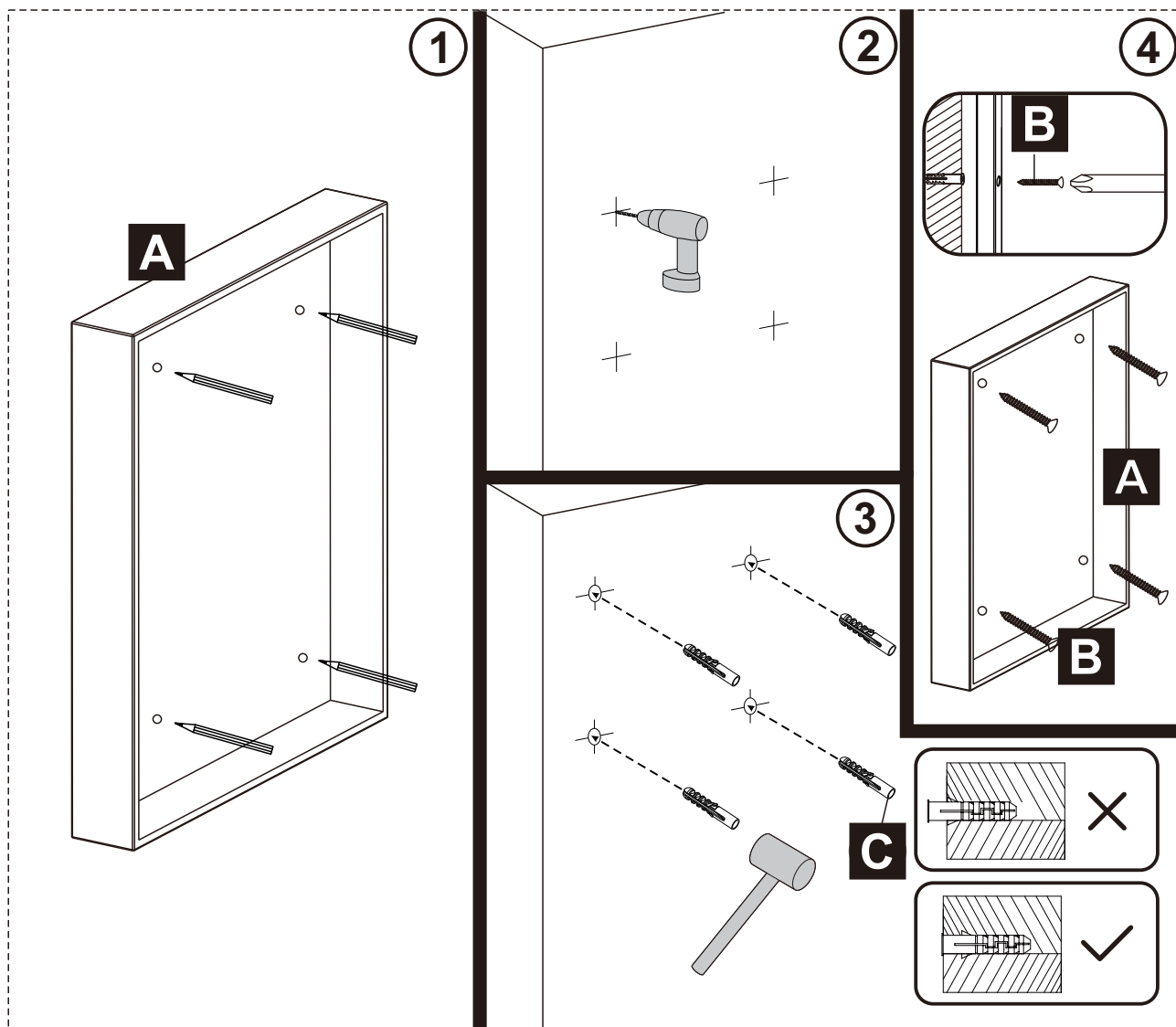
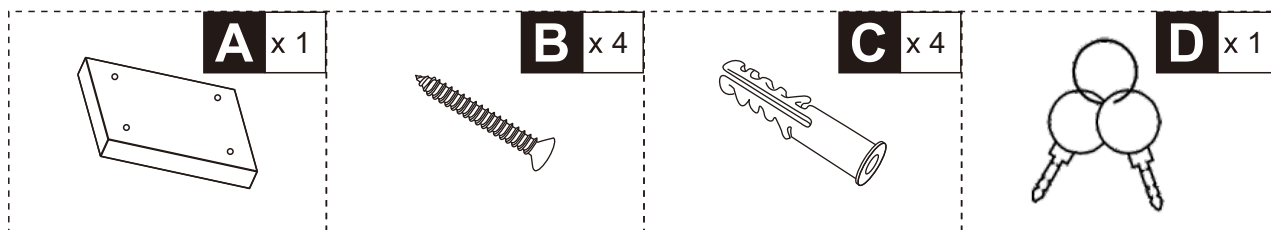

EN If it is a solid wall, please use expansion and self-tapping screws, if it is a wooden wall, only use self-tapping screws, please do not overtighten the screws

FR Si le mur est massif, veuillez utiliser des chevilles à expansion et des vis autotaraudeuses, mais s'il s'agit d'un mur en bois, utilisez uniquement des vis autotaraudeuses et ne serrez pas trop les vis.

ES Para una pared sólida, utilice los tornillos de expansión y autorroscantes. Para una pared de madera, utilice exclusivamente los tornillos autorroscantes, no los apriete demasiado.

PT Se for uma parede sólida, utilizar parafusos de expansão e auto-roscantes; se for uma parede de madeira, utilizar apenas parafusos auto-roscantes, não apertar demasiado os parafusos

DE Wenn es sich um eine Massivwand handelt, verwenden Sie bitte Dehnungs- und selbstschneidende Schrauben. Wenn es sich um eine Holzwand handelt, verwenden Sie nur selbstschneidende Schrauben, bitte ziehen Sie die Schrauben nicht zu fest an.

IT Se si tratta di un muro solido, utilizzare sia viti ad espansione che autofilettanti. Se si tratta di una parete in legno, utilizzare solo viti autofilettanti, non stringere eccessivamente le viti.

If you have any questions, please contact our customer care center, Our contact details are below:

US

 001-877-644-9366

 customerservice@aosom.com

Imported by Aosom LLC
27150 SW Kinsman Rd Wilsonville, OR 97070 USA
MADE IN CHINA

If you have any questions, please contact our customer care center, Our contact details are below:

CA

 416-792-6088

 customerservice@aosom.ca

Imported by Aosom Canada Inc.
7270 Woodbine Avenue, Unit 307, Markham,
Ontario Canada L3R 4B9
MADE IN CHINA

Si vous avez la moindre question, veuillez contacter notre centre d'assistance à la clientèle, Nos coordonnées sont les suivantes:

 416-792-6088

 customerservice@aosom.ca

Importé par Aosom Canada Inc.
7270 Woodbine Avenue, unité 307,
Markham, Ontario Canada L3R 4B9
FABRIQUÉ EN CHINE

In caso di dubbio, si prega di contattare il nostro centro assistenza clienti, I nostri dettagli di contatto sono di seguito:

IT

 0039-0249471447

 clienti@aosom.it

IMPORTATO DA/Produttore/REP:
AOSOM Italy srl
Centro Direzionale Milanofiori
Strada 1 Palazzo F1
20057 Assago (MI)
P.I.: 08567220960
FATTO IN CINA

Si tiene alguna pregunta, comuníquese con nuestro Centro de Atención al Cliente, Nuestros datos de contacto son los siguientes:

ES

 0034-931294512

 atencioncliente@aosom.es

IMPORTADOR/Fabricante/REP:
SPANISH AOSOM, S.L.
C/ROC GROS, N°15.08550, ELS HOSTALET DE
BALENYÀ, SPAIN.
B66295775
HECHO EN CHINA

Se tiver alguma dúvida, por favor contacte o nosso Centro de Atendimento ao Cliente, Os nossos dados de contacto são os seguintes:

 0034-931294512

 info@aosom.pt.

IMPORTADOR/Fabricante/REP:
SPANISH AOSOM, S.L.
C.ROC GROS N.15, 08550. ELS HOSTALET DE
BALENYÀ
FEITO NA CHINA

If you have any questions, please contact our customer care center, Our contact details are below:

UK

 0044-800-240-4004

 enquiries@mhstar.co.uk

IMPORTER ADDRESS:
MH STAR UK Ltd
1 Northampton Cross Logistics Park
Northampton Cross Road
Northampton
NN4 9FH
MADE IN CHINA

Wenn Sie Fragen haben, wenden Sie sich bitte an unser Kundendienstzentrum, Unsere Kontaktdaten stehen unten:

DE

 0049-0(40)-87408465

 service@aosom.de

ADRESSE DES IMPORTEUR/Hersteller/REP:
MH Handel GmbH
Wendenstraße 309
D-20537 Hamburg
Germany
IN CHINA HERGESTELLT

Si vous avez la moindre question, veuillez contacter notre centre d'assistance à la clientèle, Nos coordonnées sont les suivantes:

FR

 0033-1-84166106

 aosom@mhfrance.fr

Importé par/Fabricant/REP:
MH FRANCE
2 Rue Maurice Hartmann
92130 Issy Les Moulineaux
France
FABRIQUÉ EN CHINE



FR

**DONNEZ
OU
RECYCLEZ**



OU



OU



ASSOCIATION

LIVRAISON

DÉCHÈTERIE

Adresses sur quefairedemesdechets.fr