

ASSEMBLY INSTRUCTIONS

FIXED PANEL 1M

PFBSODB / PFBSODGB
PFBSODGS / PFBSODNS

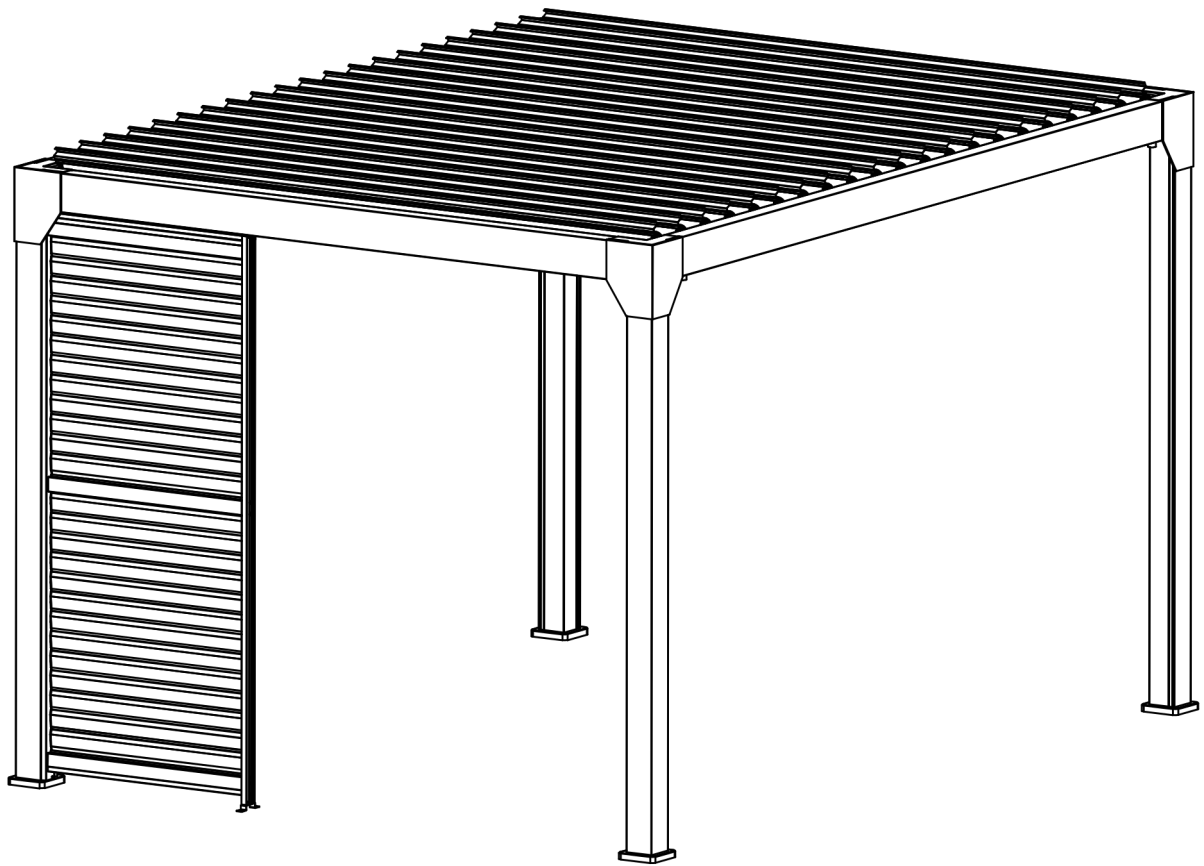

Before starting assembly of your product, make sure you wear the necessary personal protective equipment and consult the assembly instructions.



sav@green-outside.com

Photos are for illustrative purposes only. Do not litter.

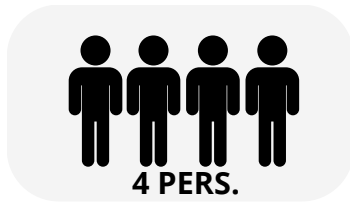



TABLE OF CONTENTS

1. SAFETY INFORMATION AND INSTRUCTIONS	-----	P.3
1.1 Tools needed	-----	p.3 p.3
1.2 Safety instructions	-----	p.3
1.3 Unpacking and checking the contents	-----	p.3
1.4 Maintenance Tips	-----	
3. LIST OF COMPONENTS	-----	P.5
4. PANEL ASSEMBLY	-----	P8
6. TROUBLESHOOTING & FREQUENTLY ASKED QUESTIONS	-----	P.26
7. WARRANTY AND CONTACT	-----	P.28

1. SAFETY INFORMATION AND INSTRUCTIONS



1.1 Tools needed

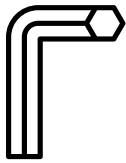

1 Allen key Ø4
(INCLUDED)

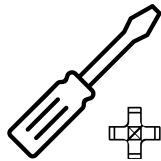

1 Phillips
screwdriver (PH1)

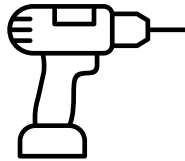

1 hammer drill / rotary
hammer

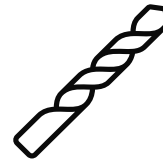

1 concrete
drill bit
Ø10



1 stepladder / person

1.2 Safety instructions

To ensure the safe assembly of your product, certain rules must be followed:

- Wearing personal protective equipment is strongly recommended (gloves, safety shoes, goggles, etc.)
- Keep children away from the construction site
- Choose a suitable location for mounting your product (flat, hard ground allowing for solid anchoring, not subject to strong winds)
- Ensure that the fixing points do not coincide with cable passages, conduits or other pipes.
- In the case of installing a pergola, provide a ground with a 1% slope to allow for the drainage of rainwater.
- Do not attempt assembly in adverse weather conditions (rain, wind, snow, etc.)
- In case of bad weather (wind, rain, snow) it is recommended to keep the blades in a semi-open position to promote airflow and prevent snow accumulation.

1.3 Unpacking the product







When opening the boxes, be careful not to use a box cutter or any blade that could damage the product. The boxes are labeled with the components inside. Make sure you have all the items listed in the components list and that they are correct before you begin assembling your product.

1.4 Maintenance Tips

- We recommend regularly cleaning your product by removing leaves, branches, or other elements that could impair its proper functioning.
- Your product can be cleaned with soapy water.
- Never use a high-pressure cleaner, corrosive products, or solvents.

In the event that a component is missing, damaged, or if you have any doubts, please contact Green Outside customer service:
sav@green-outside.com

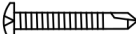
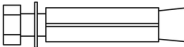
3. List of components

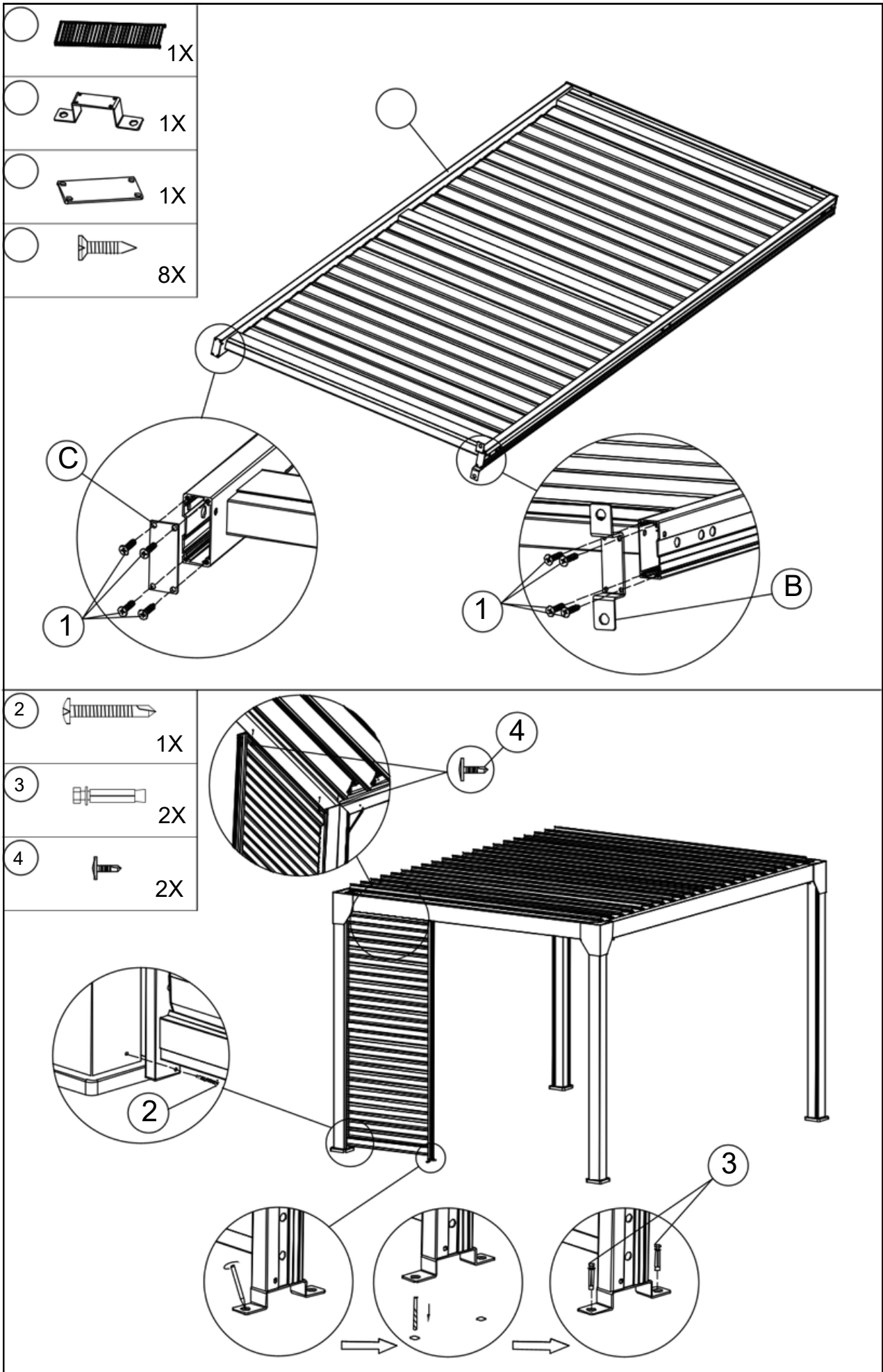

Reference	Component	Quantity	Representation
A	Ventail	1	
B	Mounting bracket	1	
C	Foot finishing plate	1	
D	Foot cover	2	
1		8	
2		1	
3		2	
4		2	
5		4	

left side screen installation method

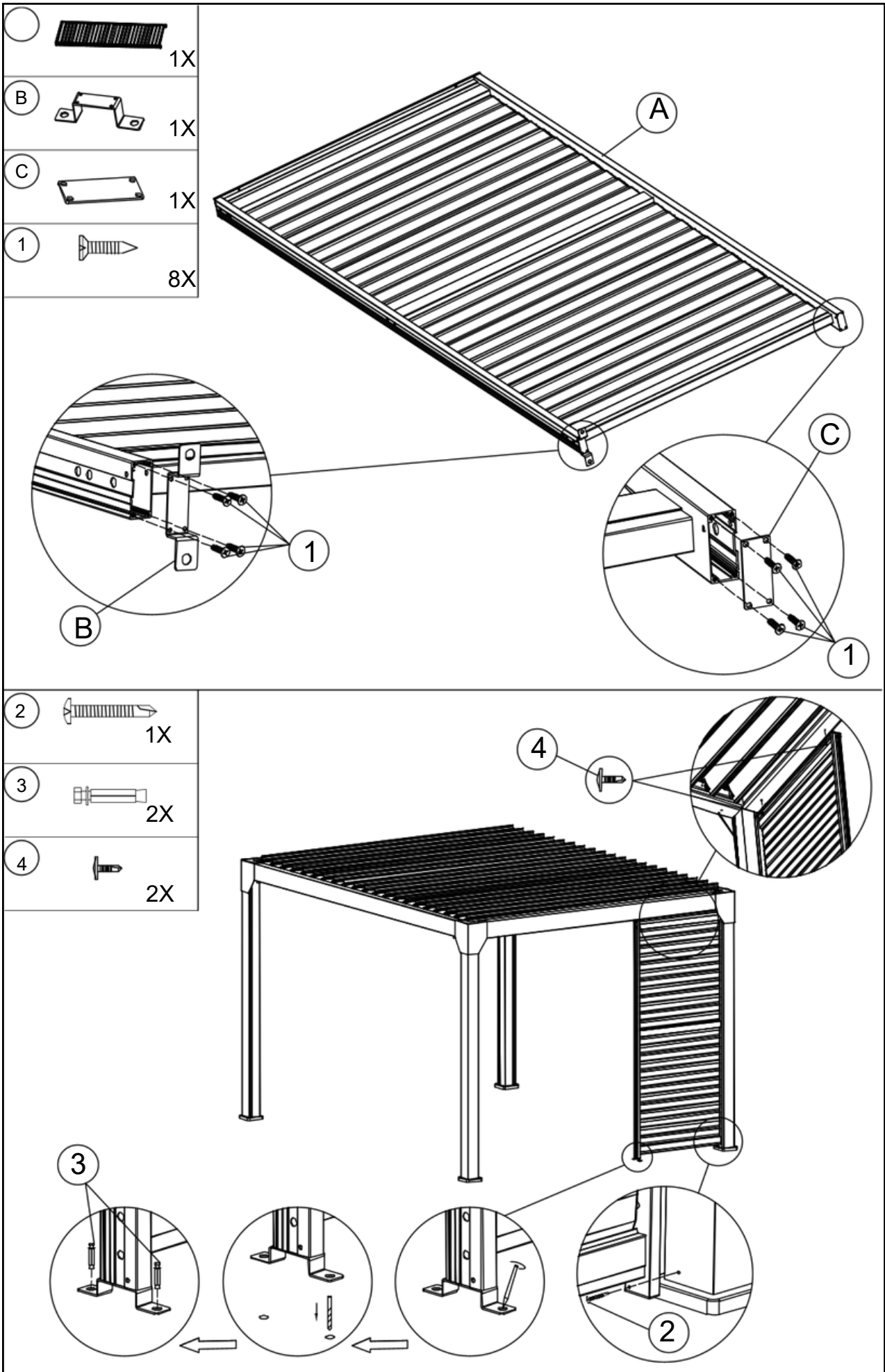

right screen installation method



D		1X
3		4X

