

PawHut

IN251100437V01_GL

D51-435V04

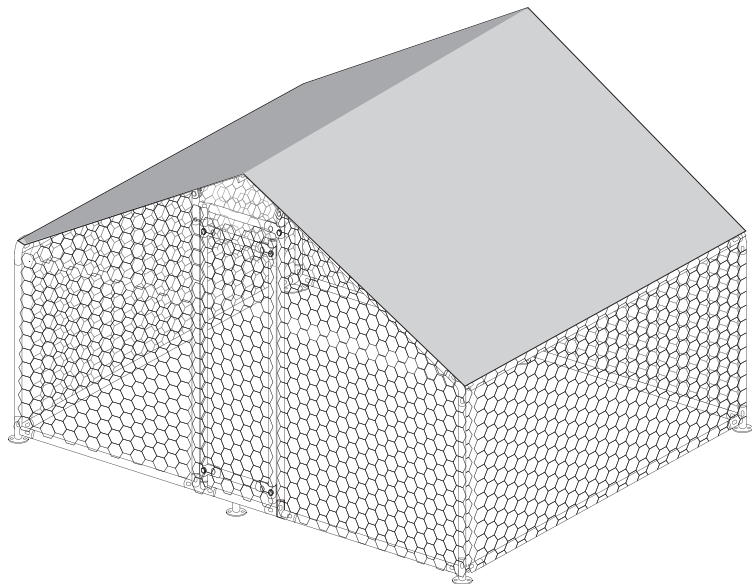

10
STEPS

2 HR



EN_IMPORTANT, RETAIN FOR FUTURE REFERENCE: READ CAREFULLY.

FR_IMPORTANT: A LIRE ATTENTIVEMENT ET À CONSERVER POUR CONSULTATION ULTÉRIEURE.

ES_IMPORTANTE, LEA Y GUARDE PARA FUTURAS REFERENCIAS.

PT_IMPORTANTE, RETER PARA REFERÊNCIA FUTURA: LEIA ATENTAMENTE.

DE_WICHTIG! SORGFÄLTIG LESEN UND FÜR SPÄTER NACHSCHLAGEN AUFBEWAHREN.

IT_IMPORTANTE! CONSERVARE IL PRESENTE MANUALE PER FUTURO RIFERIMENTO E LEGGERLO ATTENTAMENTE.

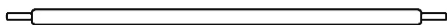
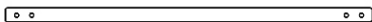
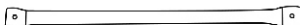
**1** x 4
918**2** x 5
1915**3** x 4
1292**4** x 4
950**5** x 1
1785**5A** x 1
1785**6** x 1
595**7** x 1
1880**A** x 1
1690**1A** x 1
1690**C** x 2
565

D x 5



E1 x 2



E2 x 2



F x 1



G x 1



V x 1



I x 8



J x 2



J1 x 2



K x 18
M6
+1(spare)



M x 2



O x 1

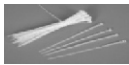

P x 1



Q x 1

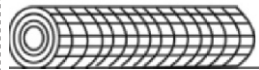

R x 20



S x 1



T x 2



W x 6

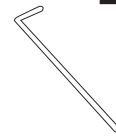



EN_ATTENTION: E1 & E2 shall be placed in strict order, otherwise they cannot be installed

FR_ATTENTION : E1 et E2 doivent être placés dans un ordre strict, sinon ils ne peuvent pas être installés.

ES_ATENCIÓN: E1 y E2 deben colocarse en estricto orden, de lo contrario no podrán instalarse.

PT_ATENÇÃO: E1 e E2 devem ser colocados por ordem rigorosa, caso contrário não podem ser instalados

DE_ACHTUNG: E1 und E2 müssen in strenger Reihenfolge angebracht werden, da sie sonst nicht installiert werden können.

IT_ATTENZIONE: E1 ed E2 devono essere posizionati in ordine rigoroso, altrimenti non possono essere installati.

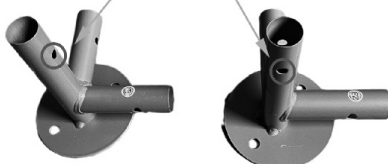

E1

E2

E1

E2

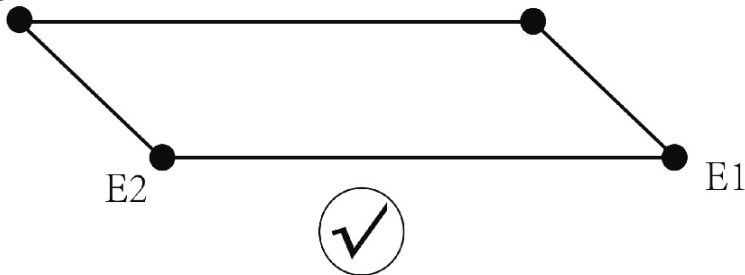





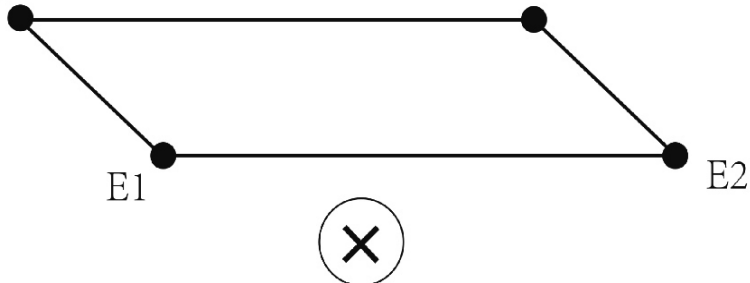

E2

E1



STEP1

Required Tools	 ①*4PCS	 ②*2PCS	 E1*2PCS
 E2*2PCS	 G*1PCS	 F*1PCS	

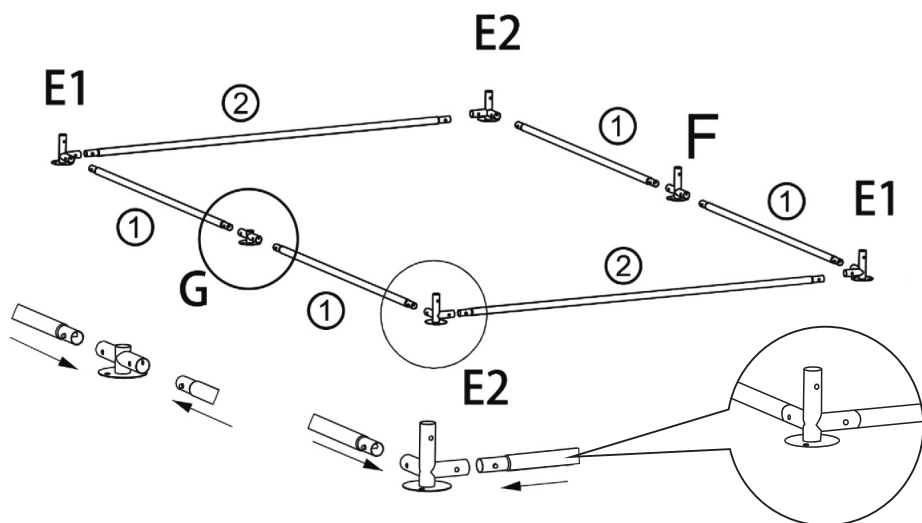

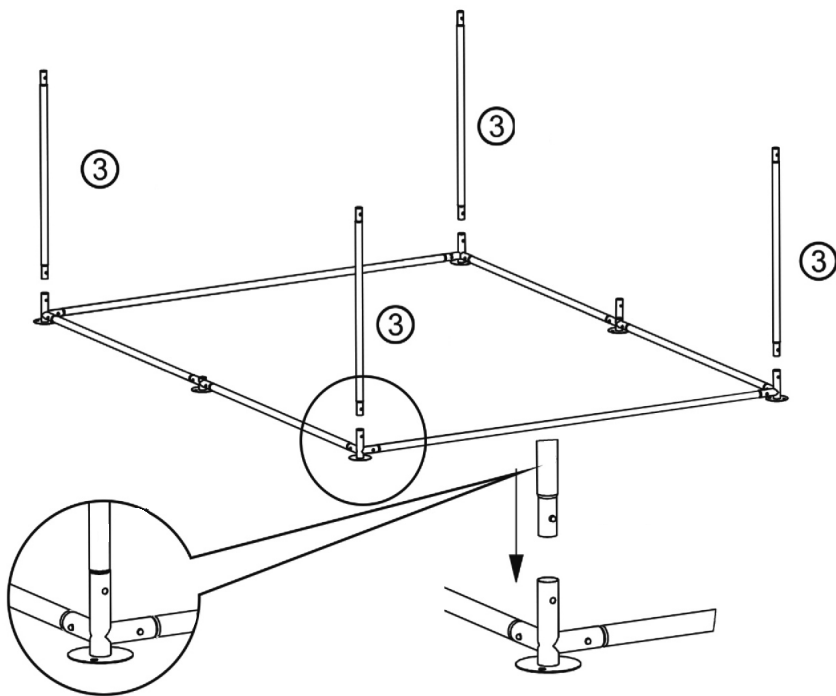

STEP2

Required
Tools



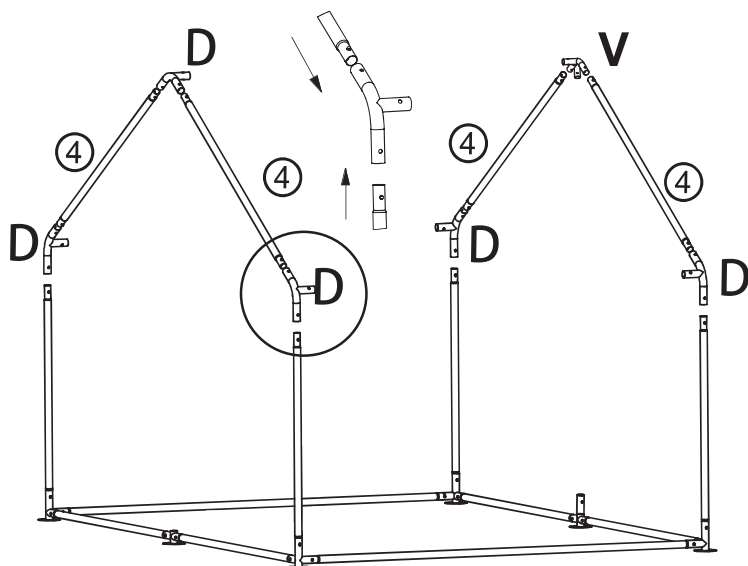

STEP3

Required Tools	 ④*4PCS	 D*5PCS	 V*1PCS
-------------------	---	---	---





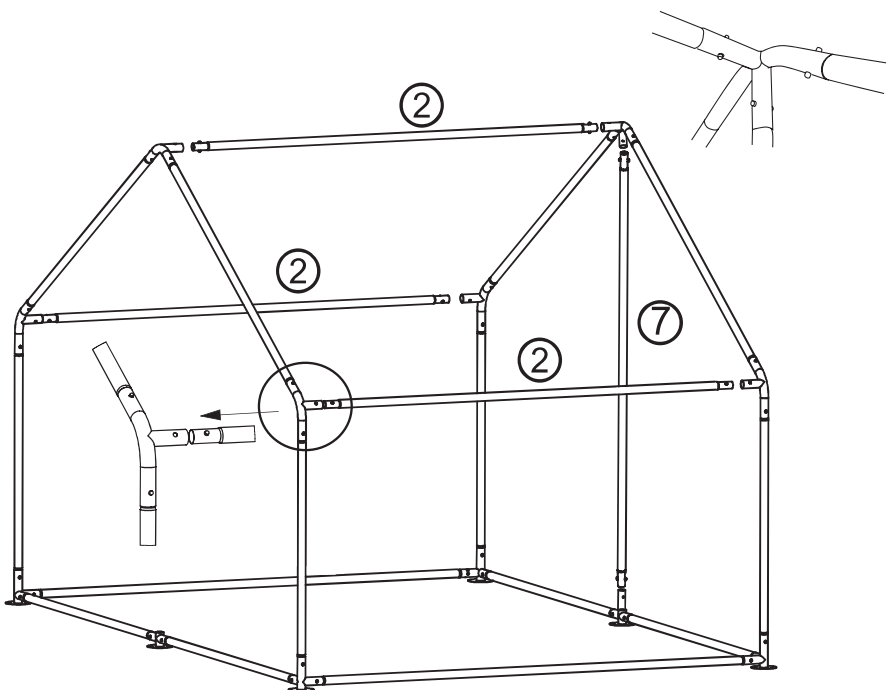

STEP4

Required Tools	 ②*3PCS	 ○*1PCS
-------------------	---	---



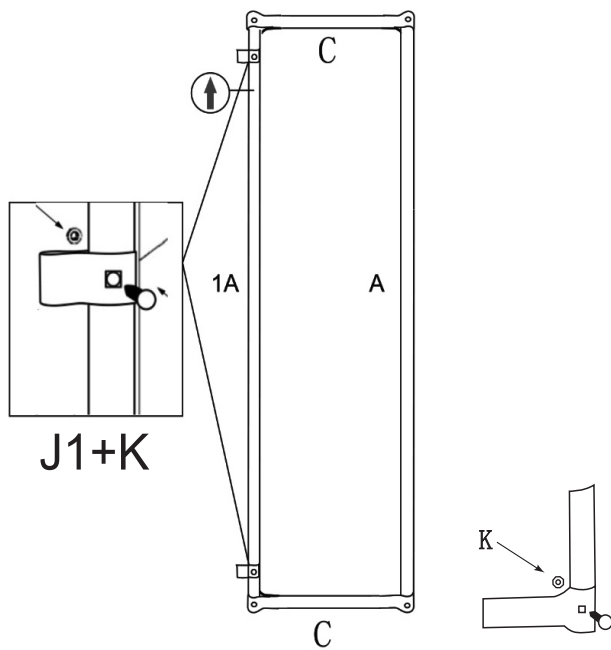

STEP6

Required Tools	 1A*1PCS	 A*1PCS	 C*2PCS	 J1*2PCS	 K*6PCS
-------------------	---	--	--	---	--



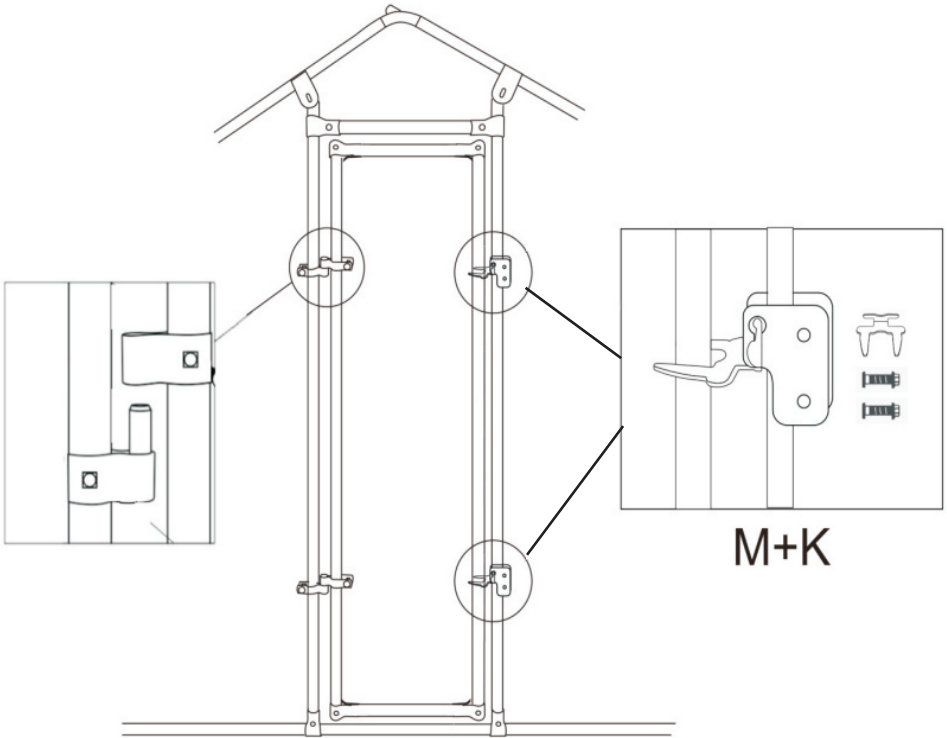

STEP7

Required Tools	 M*2PCS	 K*4PCS
-------------------	---	---



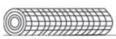

STEP8

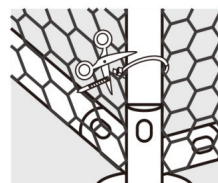
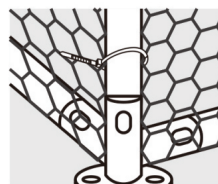
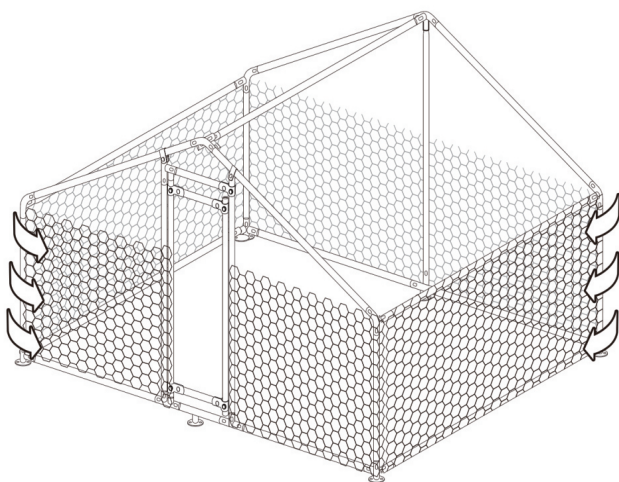
Required Tools	 Q*1PCS	 O*1SET
-------------------	---	---



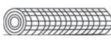

STEP9

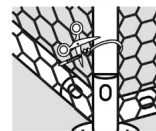
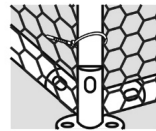
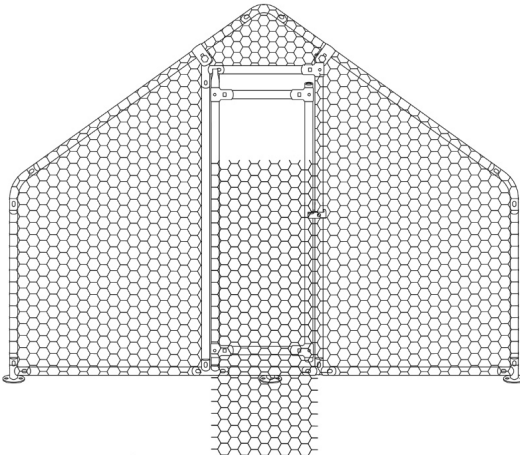
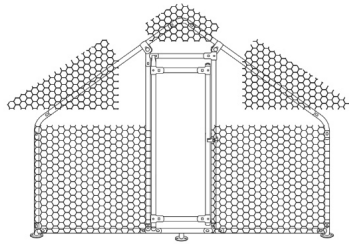
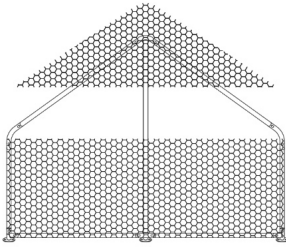
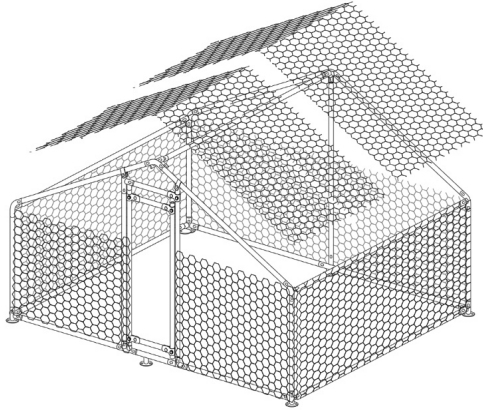
Required Tools		
	Q*1PCS	O*1SET



STEP10

Required Tools	 P*1PCS	 R*20PCS	 W*6PCS
-------------------	---	--	---

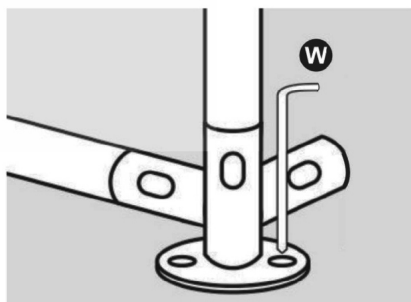
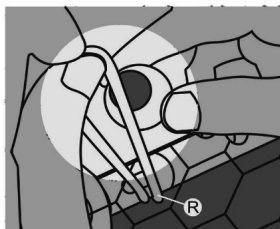
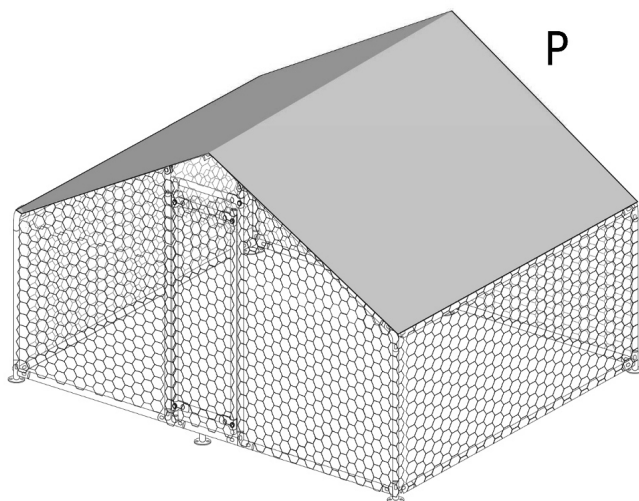

If you have any questions, please contact our customer care center, Our contact details are below:

US

 001-877-644-9366

 customerservice@aosom.com

Imported by Aosom LLC
27150 SW Kinsman Rd Wilsonville, OR 97070 USA
MADE IN CHINA

If you have any questions, please contact our customer care center, Our contact details are below:

CA

 416-792-6088

 customerservice@aosom.ca

Imported by Aosom Canada Inc.
7270 Woodbine Avenue, Unit 307, Markham,
Ontario Canada L3R 4B9
MADE IN CHINA

Si vous avez la moindre question, veuillez contacter notre centre d'assistance à la clientèle, Nos coordonnées sont les suivantes:

 416-792-6088

 customerservice@aosom.ca

Importé par Aosom Canada Inc.
7270 Woodbine Avenue, unité 307,
Markham, Ontario Canada L3R 4B9
FABRIQUÉ EN CHINE

In caso di dubbio, si prega di contattare il nostro centro assistenza clienti, I nostri dettagli di contatto sono di seguito:

IT

 0039-0249471447

 clienti@aosom.it

IMPORTATO DA/Produttore/REP:
AOSOM Italy srl
Centro Direzionale Milanofiori
Strada 1 Palazzo F1
20057 Assago (MI)
P.I.: 08567220960
FATTO IN CINA

Si tiene alguna pregunta, comuníquese con nuestro Centro de Atención al Cliente, Nuestros datos de contacto son los siguientes:

ES

 0034-931294512

 atencioncliente@aosom.es

IMPORTADOR/Fabricante/REP:
SPANISH AOSOM, S.L.
C/ROC GROS, Nº15.08550, ELS HOSTALETS DE
BALENYÀ, SPAIN.
B66295775
HECHO EN CHINA

Se tiver alguma dúvida, por favor contacte o nosso Centro de Atendimento ao Cliente, Os nossos dados de contacto são os seguintes:

 0034-931294512

 info@aosom.pt.

IMPORTADOR/Fabricante/REP:
SPANISH AOSOM, S.L
C.ROC GROS N.15, 08550. ELS HOSTALETS DE
BALENYÀ
FEITO NA CHINA

If you have any questions, please contact our customer care center, Our contact details are below:

UK

 0044-800-240-4004

 enquiries@mhstar.co.uk

IMPORTER ADDRESS:
MH STAR UK Ltd
1 Northampton Cross Logistics Park
Northampton Cross Road
Northampton
Nn4 9FH
MADE IN CHINA

Wenn Sie Fragen haben, wenden Sie sich bitte an unser Kundendienstzentrum, Unsere Kontaktdaten stehen unten:

DE

 0049-0(40)-87408465

 service@aosom.de

ADRESSE DES IMPORTEURE/Hersteller/REP:
MH Handel GmbH
Wendenstraße 309
D-20537 Hamburg
Germany
IN CHINA HERGESTELLT

Si vous avez la moindre question, veuillez contacter notre centre d'assistance à la clientèle, Nos coordonnées sont les suivantes:

FR

 0033-1-84166106

 aosom@mhfrance.fr

Importé par/Fabricant/REP:
MH FRANCE
2 Rue Maurice Hartmann
92130 Issy Les Moulineaux
France
FABRIQUÉ EN CHINE



FR
DONNEZ
OU
RECYCLEZ



ASSOCIATION

OU



LIVRAISON

OU



DÉCHÈTERIE

Adresses sur quefairedemesdechets.fr