

BOYOMA

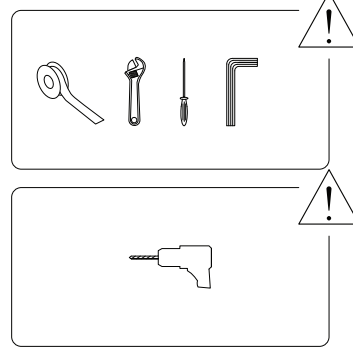

20'

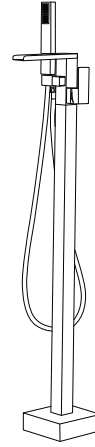
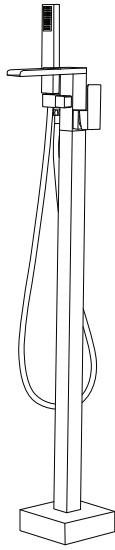

1

Beliani

1/9

Beliani

8/76/BOYOMA/030423/

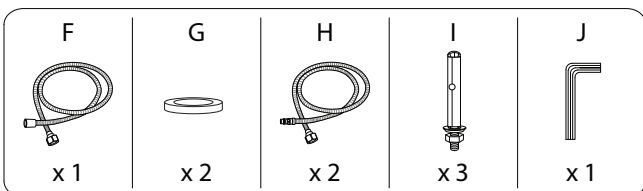
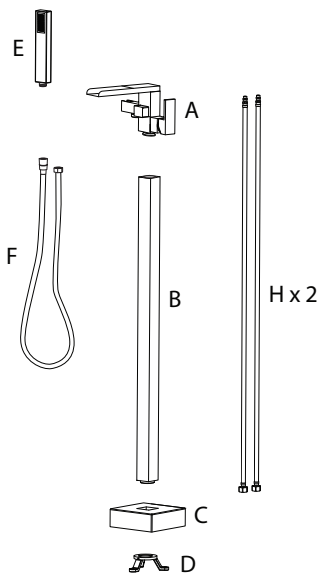
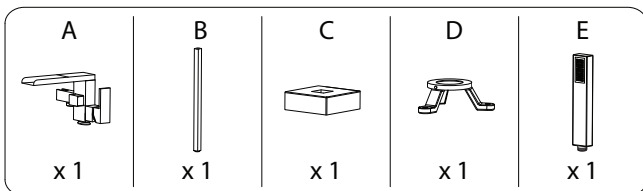

2/9

Beliani

8/76/BOYOMA/030423/

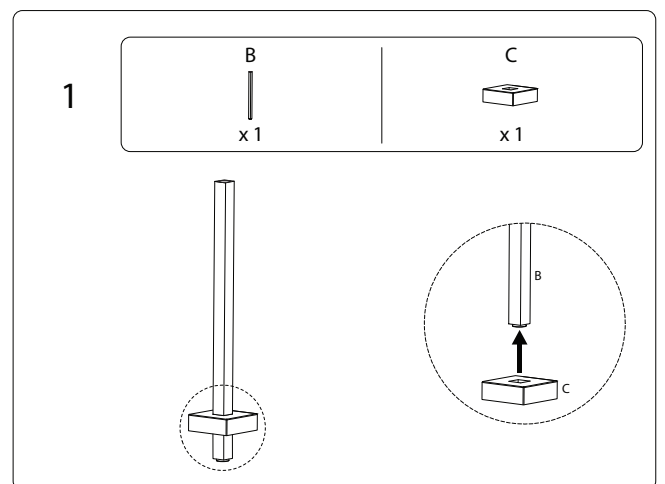
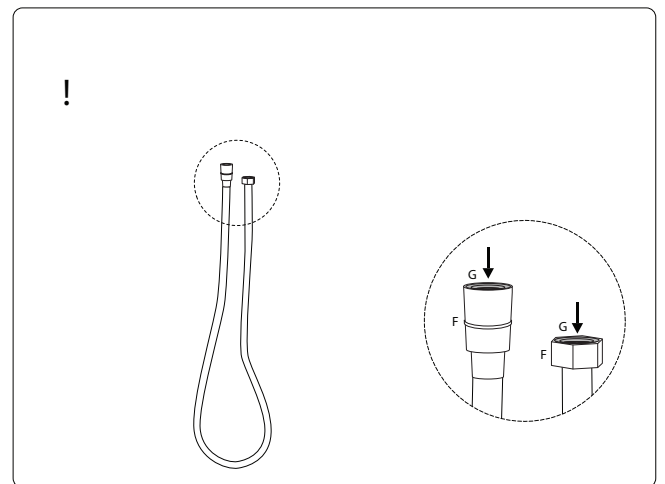

3/9

Beliani

8/76/BOYOMA/030423/

2

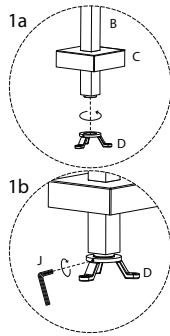
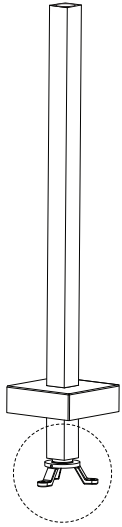

4/9

Beliani
8/76/BOYOMA/030423/

3

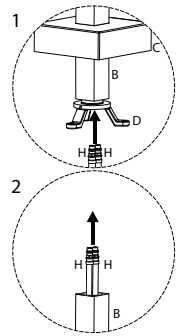
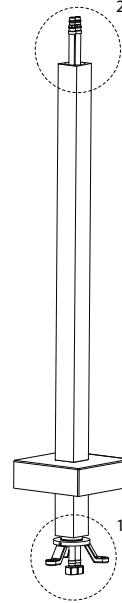
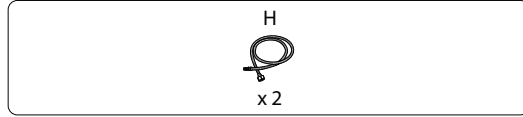

5/9

Beliani
8/76/BOYOMA/030423/

4

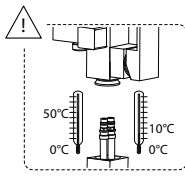
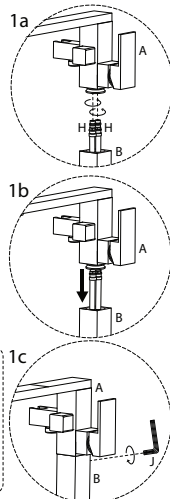
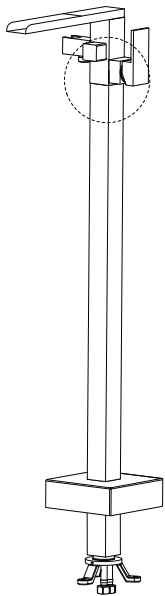
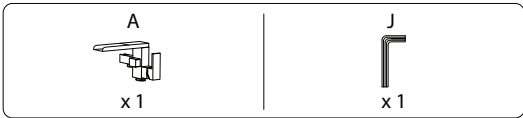

6/9

Beliani
8/76/BOYOMA/030423/

4

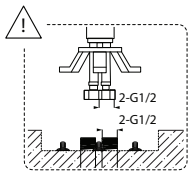
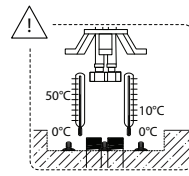
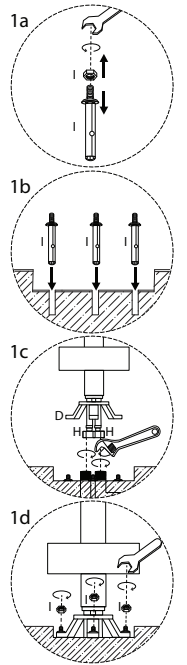
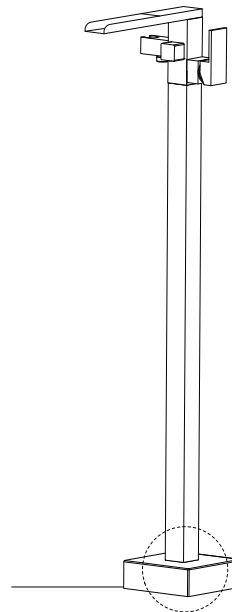
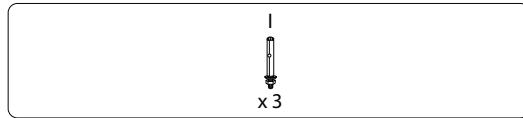

7/9

Beliani
8/76/BOYOMA/030423/

!

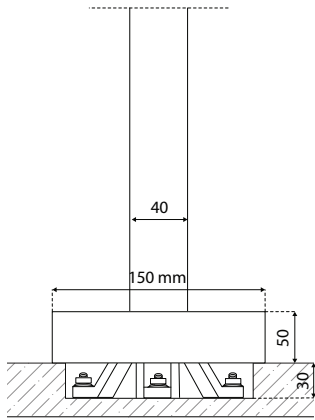

8/9

Beliani
8/76/BOYOMA/030423/

5

E

x 1

F

x 1

G

x 2

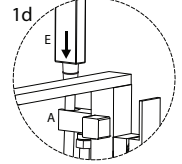
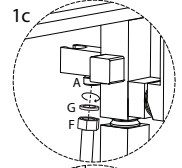
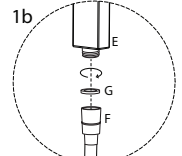
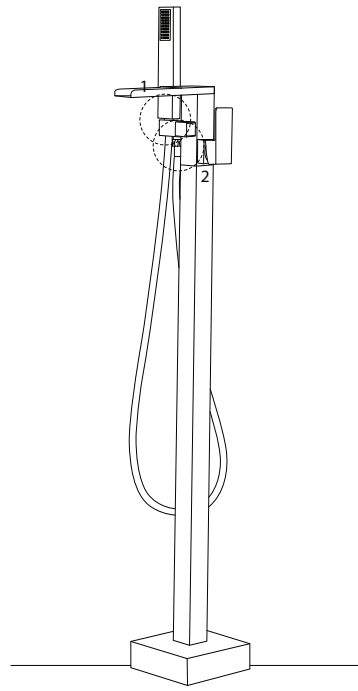

9/9

Beliani
8/76/BOYOMA/030423/