

# CAZEBOO

## AGOSTA 400L300

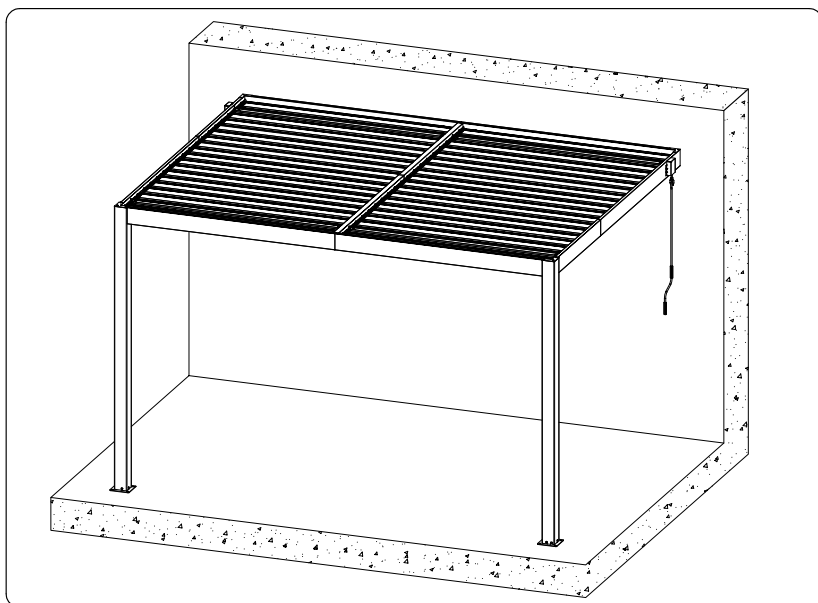

EN FR DE ES PT IT NL PL FI SE DK



INSTRUCTION MANUAL / NOTICE DE MONTAGE / MONTAGEANLEITUNG / MANUAL DE MONTAJE / MANUAL DE MONTAGEM  
/ MANUALE DI MONTAGGIO / MONTAGEHANDLEIDING / INSTRUKCJA MONTAŻU / KÄYTTÖOHJEET / BRUKSANVISNING /  
BRUGSANVISNING



## **BEFORE STARTING THE INSTALLATION :**

**EN**

- Please read all the instructions in this manual before starting to install your Pergola
- Please check the contents of each box thanks to the parts list
- Do not discard cartons until the product is fully assembled
- Before purchasing or assembling this product, consult your local authorities regarding the installation of temporary structures.

Some jurisdictions may require building permits, or otherwise regulate installation and use.

When you are ready to begin, make sure you have the right tools, plenty of space and a clean, dry place to assemble your pergola.



## **AVANT DE COMMENCER L'INSTALLATION :**

**FR**

- Veuillez lire intégralement les indications de cette notice avant de commencer à poser votre Pergola.
- Veuillez vérifier le contenu de chaque carton à l'aide de la liste des pièces.
- Ne pas jeter les cartons avant que le produit soit entièrement assemblé.
- Avant d'acheter ou d'assembler ce produit, consultez les autorités locales concernant l'installation de structures temporaires.

Certaines juridictions peuvent exiger des permis de construction, ou autrement réglementer l'installation et l'utilisation.

Lorsque vous êtes prêt à commencer, assurez-vous que vous avez les bons outils, beaucoup d'espace et un endroit propre et sec pour l'assemblage de votre pergola.



## **ANTES DE EMPEZAR A INSTALAR :**

**ES**

- Por favor, lea todas las instrucciones de este manual antes de empezar a instalar su pérgola
- Compruebe el contenido de cada caja con la lista de piezas
- No deseche las cajas hasta que el producto esté completamente montado
- Antes de comprar o montar este producto, consulte a las autoridades locales sobre la instalación de estructuras temporales.

Algunas jurisdicciones pueden exigir permisos de construcción o regular de otro modo la instalación y el uso.

Cuando esté listo para empezar, asegúrese de tener las herramientas adecuadas, mucho espacio y un lugar limpio y seco para montar su pérgola.

**BEVOR SIE MIT DER INSTALLATION BEGINNEN :****DE**

- Bitte lesen Sie alle Anweisungen in diesem Handbuch, bevor Sie mit der Installation Ihrer Pergola beginnen.
- Überprüfen Sie bitte den Inhalt jedes Kartons anhand der Stückliste.
- Werfen Sie die Kartons nicht weg, bevor das Produkt vollständig montiert ist.
- Informieren Sie sich vor dem Kauf oder der Montage dieses Produkts bei den örtlichen Behörden über die Installation von temporären Strukturen.

In einigen Ländern ist möglicherweise eine Baugenehmigung erforderlich, oder es gibt andere Vorschriften für die Installation und Verwendung.

Wenn Sie bereit sind, mit dem Aufbau zu beginnen, vergewissern Sie sich, dass Sie das richtige Werkzeug, ausreichend Platz und einen sauberen, trockenen Ort für den Aufbau Ihrer Pergola haben.

**PRIMA DI INIZIARE L'INSTALLAZIONE :****IT**

- Prima di iniziare l'installazione della Pergola, leggere tutte le istruzioni contenute in questo manuale.
- Controllare il contenuto di ogni scatola con l'elenco dei componenti.
- Non gettare i cartoni finché il prodotto non è completamente assemblato.
- Prima di acquistare o montare questo prodotto, consultare le autorità locali in merito all'installazione di strutture temporanee.

Alcune giurisdizioni possono richiedere permessi di costruzione o regolamentare in altro modo l'installazione e l'uso.

Quando siete pronti per iniziare, assicuratevi di avere gli attrezzi giusti, molto spazio e un luogo pulito e asciutto per montare la vostra pergola.

**ANTES DE COMEÇAR A INSTALAÇÃO :****PT**

- Por favor leia todas as instruções deste manual antes de começar a instalar a sua Pérgola
- Por favor, verifique o conteúdo de cada caixa em relação à lista de peças
- Não deitar fora as caixas até o produto estar completamente montado
- Antes de comprar ou montar este produto, consulte as suas autoridades locais relativamente à instalação de estruturas temporárias.

Algumas jurisdições podem exigir licenças de construção, ou regular de outra forma a instalação e utilização.

Quando estiver pronto para começar, certifique-se de ter as ferramentas adequadas, bastante espaço e um local limpo e seco para montar a sua pérgola.



## **VOORDAT U MET DE INSTALLATIE BEGINT :**

**NL**

- Lees alle instructies in deze handleiding voordat u begint met de installatie van uw Pergola.
- Controleer de inhoud van elke doos dankzij de onderdelenlijst
- Gooi de dozen pas weg als het product volledig gemonteerd is.
- Voordat u dit product koopt of monteert, moet u de plaatselijke autoriteiten raadplegen over de installatie van tijdelijke constructies.

Sommige jurisdicties kunnen een bouwvergunning vereisen of op een andere manier de installatie en het gebruik regelen.

Wanneer u klaar bent om te beginnen, zorg dan voor het juiste gereedschap, voldoende ruimte en een schone, droge plaats om uw pergola in elkaar te zetten.



## **PRZED ROZPOCZĘCIEM MONTAŻU :**

**PL**

- Proszę przeczytać wszystkie instrukcje zawarte w tym podręczniku przed rozpoczęciem montażu Pergoli .
- Proszę sprawdzić zawartość każdego kartonu dzięki liście części
- Nie wyrzucaj kartonów, dopóki produkt nie zostanie w pełni zmontowany

Przed zakupem lub montażem tego produktu należy skonsultować się z lokalnymi władzami w sprawie instalacji tymczasowych konstrukcji.

W niektórych jurysdykcjach mogą być wymagane pozwolenia budowlane lub inne regulacje dotyczące instalacji i użytkowania.

Kiedy będziesz gotowy do rozpoczęcia, upewnij się, że masz odpowiednie narzędzia, dużo miejsca i czyste, suche miejsce do montażu pergoli.



## **FØR INSTALLATIONEN PÅBEGYNDENES :**

**DK**

- Læs venligst alle instruktionerne i denne manual, før du begynder at installere din pergola.
- Kontroller indholdet af hver kasse takket være styklisten
- Kassér ikke kasserne, før produktet er fuldt monteret
- Før du køber eller samler dette produkt, skal du konsultere dine lokale myndigheder vedrørende installation af midlertidige konstruktioner.

Nogle jurisdiktioner kan kræve byggetilladelser eller på anden måde regulere installation og brug.

Når du er klar til at gå i gang, skal du sørge for at have det rigtige værktøj, masser af plads og et rent og tørt sted at samle din pergola.

**ENNEN ASENNUKSEN ALOITTAMISTA :****FI**

- Lue kaikki tämän käyttöohjeen ohjeet ennen kuin aloitat Pergolan asennuksen.
- Tarkista kunkin laatikon sisältö osaluettelon avulla.
- Älä hävitä pahvilaatikoita ennen kuin tuote on täysin koottu.
- Ennen tämän tuotteen ostamista tai kokoamista ota yhteyttä paikallisiin viranomaisiin tilapäisten rakenteiden asentamisen osalta.

Jotkin lainkäyttöalueet saattavat vaatia rakennuslupia tai muuten säännellä asennusta ja käyttöä.

Kun olet valmis aloittamaan, varmista, että sinulla on oikeat työkalut, runsaasti tilaa ja puhdas, kuiva paikka pergolan kokoamiseen.

**INNAN DU PÅBÖRJJAR INSTALLATIONEN :****SE**

- nna manual innan du börjar installera din pergola.
- Kontrollera innehållet i varje låda med hjälp av delförteckningen.
- Kasta inte kartongerna förrän produkten är helt monterad.
- Innan du köper eller monterar den här produkten ska du rådfråga de lokala myndigheterna om installation av tillfälliga konstruktioner.

Vissa jurisdiktioner kan kräva byggnadstillstånd eller på annat sätt reglera installation och användning.

När du är redo att börja, se till att du har rätt verktyg, gott om utrymme och en ren och torr plats för att montera din pergola.



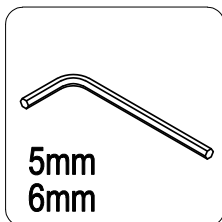
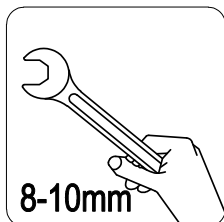
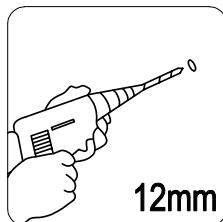
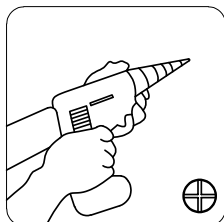
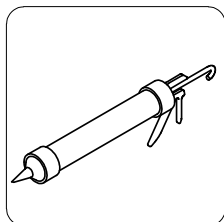
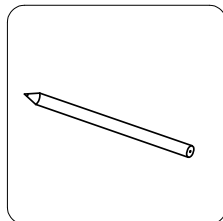
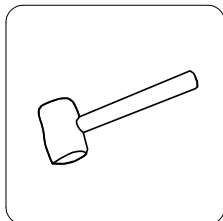
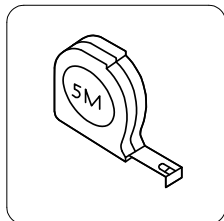
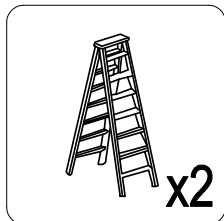

OUTILS NÉCESSAIRES / ERFORDERLICHE WERKZEUGE / HERRAMIENTAS NECESARIAS / FERRAMENTAS NECESSÁRIAS /  
STRUMENTI NECESSARI / VEREIST GEREEDSCHAP / WYMAGANE NARZĘDZIA / TARVITAVAT TYÖKALUT  
/ VERKTYG SOM KRÄVS / NØDVENDIGT VÆRKTØJ

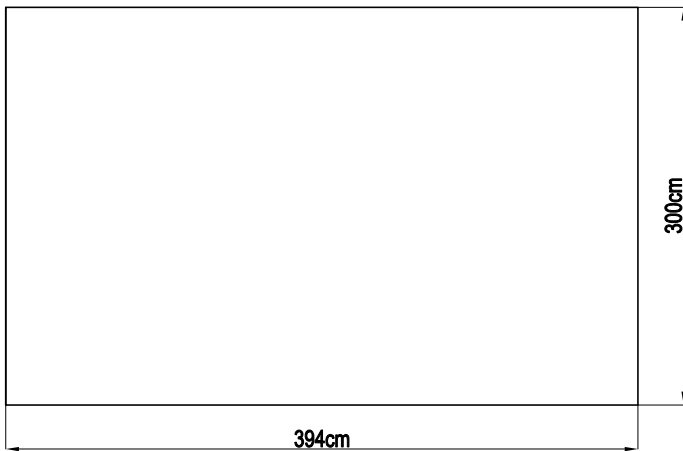
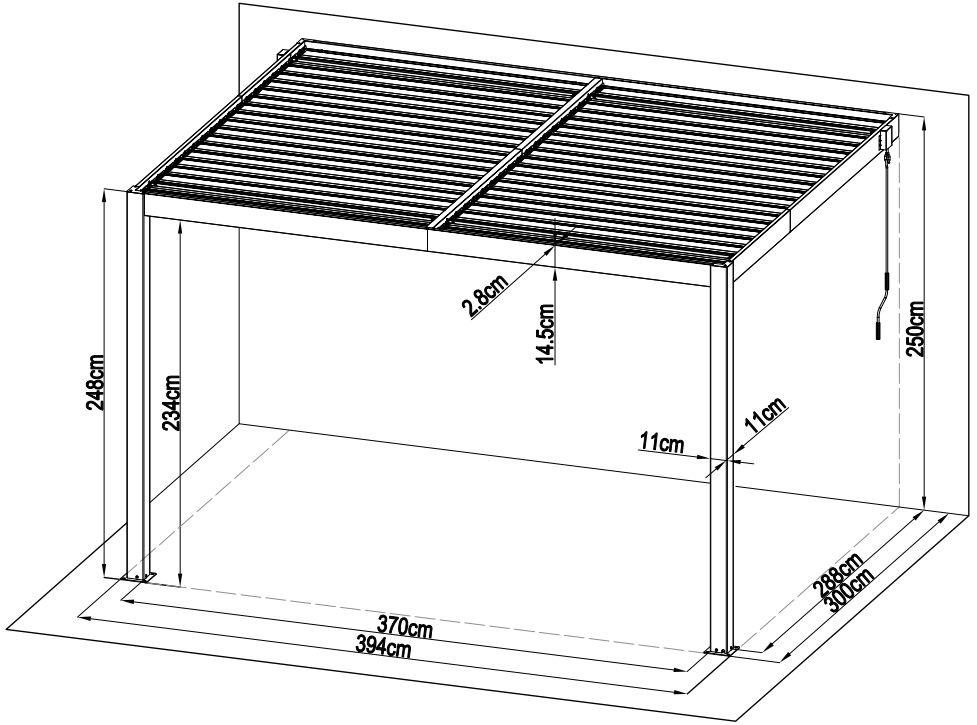

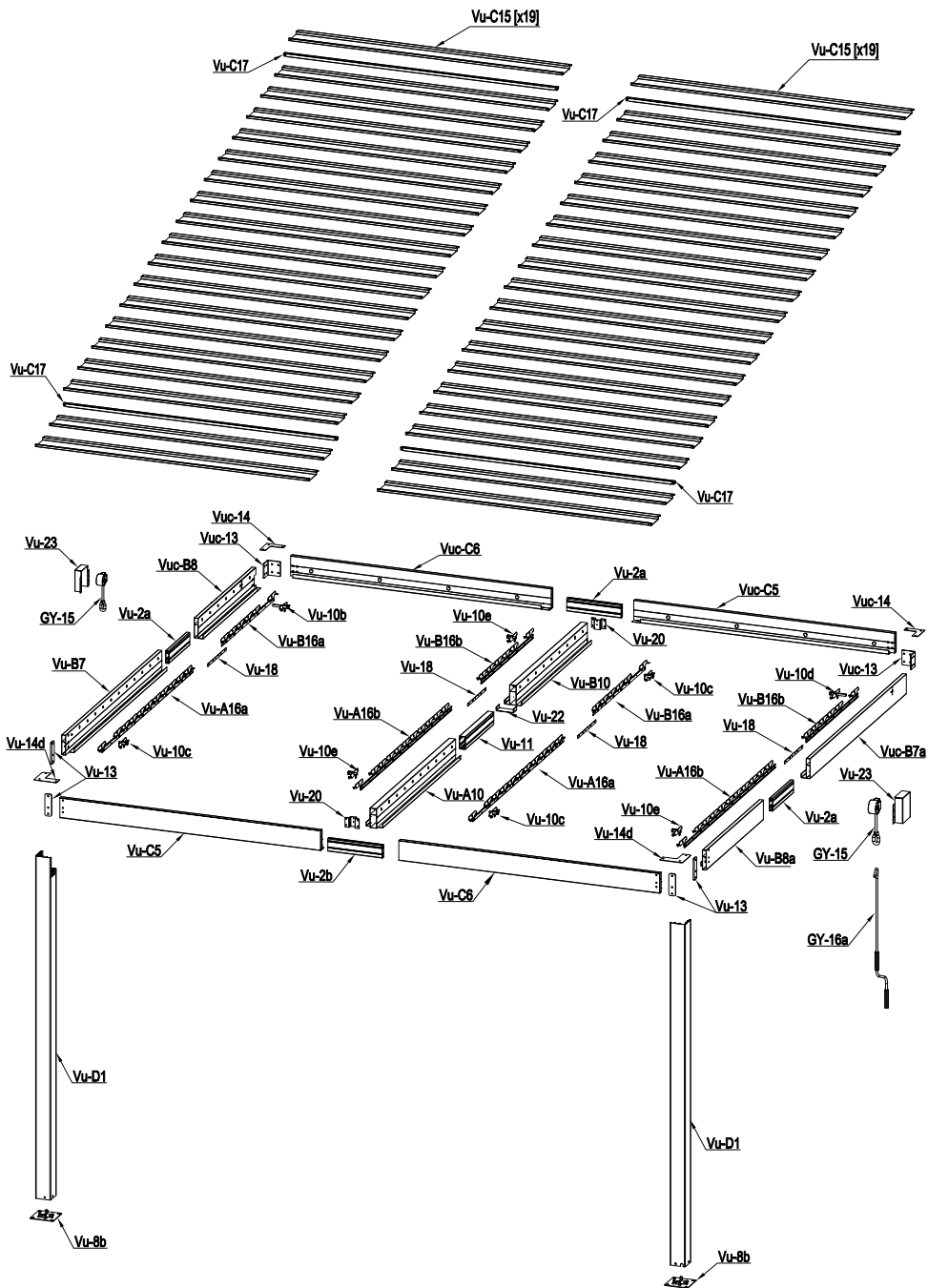





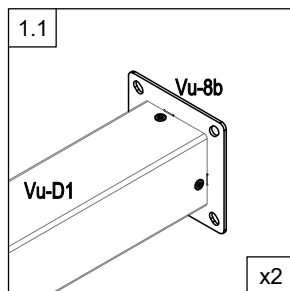
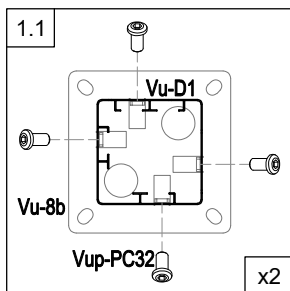
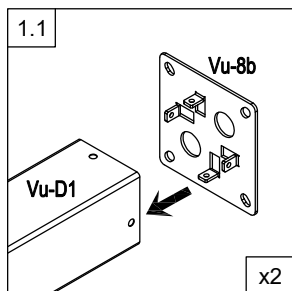
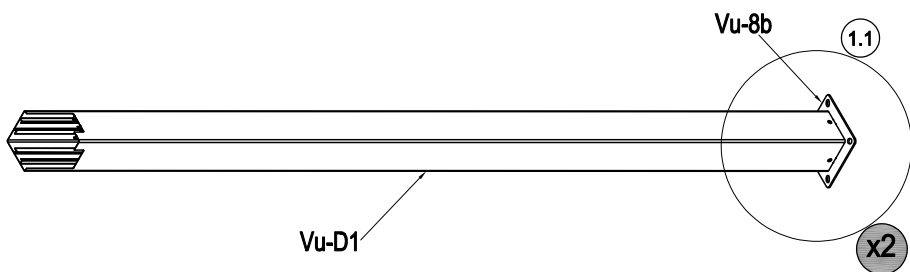
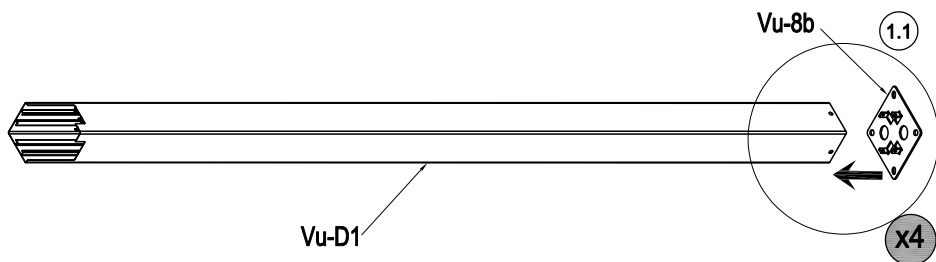



NO.	IMAGE	mm	QTY	NO.	IMAGE	mm	QTY	
Vu-D1		2475	x2	GY-15			x2	
Vu-C5		1900	x1	GY-16a			x1	
Vu-C6		1900	x1	Vu-21			x68	
Vuc-C5		1900	x1	Vu-26			x76	
Vuc-C6		1900	x1	Vuc-PC30		M8x10	x12	
Vu-B7		1855	x1	Vuc-PC31		M8	x12	
Vuc-B7a		1855	x1	Vuc-PC32		M8x12	x24	
Vuc-B8		1100	x1	Vuc-PC34		ST4.8x16	x120	
Vu-B8a		1100	x1	Vuc-PC35		M5x15	x8	
Vu-2a			400	x3	Vuc-PC36		M5	x8
Vu-2b			800	x1	Vuc-PC37		M6x25	x8
Vu-A10		1525	x1	Vuc-PC38		M6x40	x6	
Vu-B10		1374	x1	Vuc-PC39		M6	x14	
Vu-11		800	x1	Vuc-PC40		M6	x14	
Vu-A16a		1751.5	x2	Vuc-PC41		M8x31	x68	
Vu-A16b		1751.5	x2	Vuc-PC42		M4x10	x80	
Vu-B16a		996.5	x2	Vuc-PC43		M4x10	x16	
Vu-B16b		996.5	x2	Vuc-PC44		M4	x20	
Vu-C17		1806	x4	Vuc-PC45		M8x70	x16	
Vu-C15		1841	x38					
Vu-8b			x2					
Vu-10b			x1					
Vu-10c			x3					
Vu-10d			x1					
Vu-10e			x3					
Vu-13			x4					
Vuc-13			x2					
Vu-14d			x2					
Vuc-14			x2					
Vu-18			x4					
Vu-20			x2					
Vu-22			x1					
Vu-23			x2					

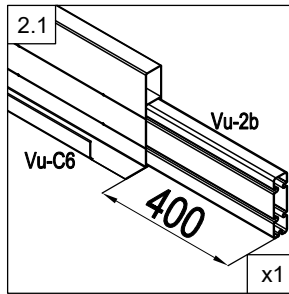
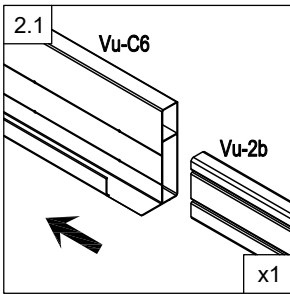
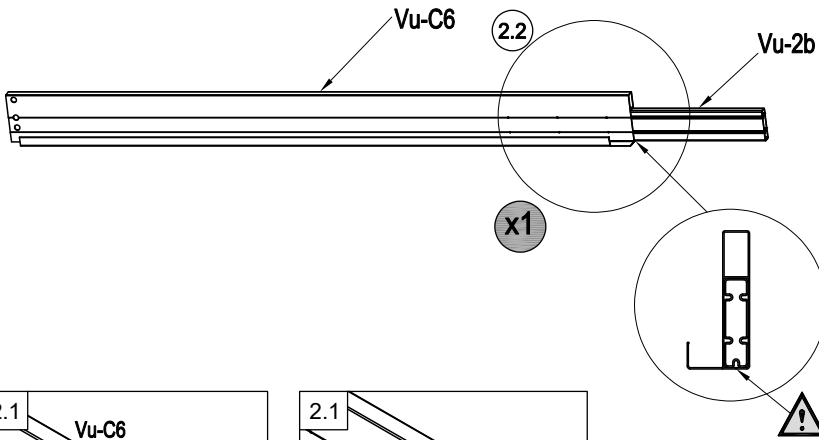
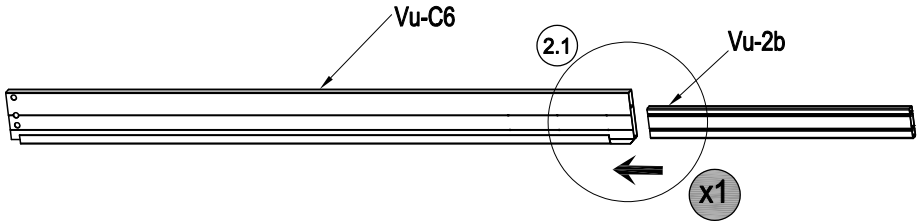



	Vu-D1	2		Vu-8b	2		Vup-PC32	8
---	-------	---	---	-------	---	---	----------	---

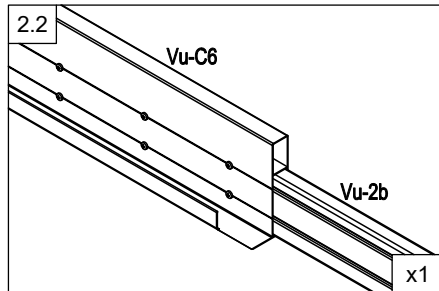
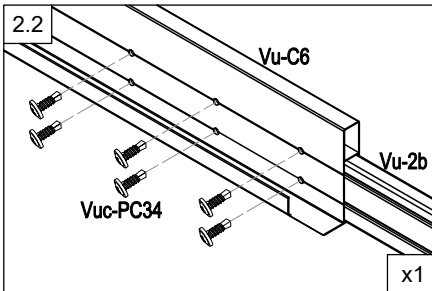

	Vu-C6	1
	Vu-2b	1
	Vuc-PC34	6

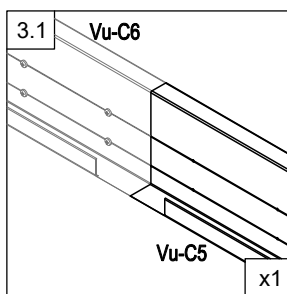
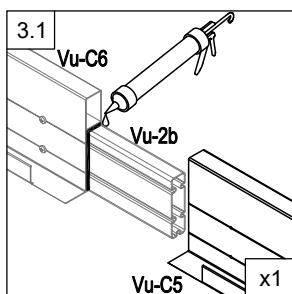
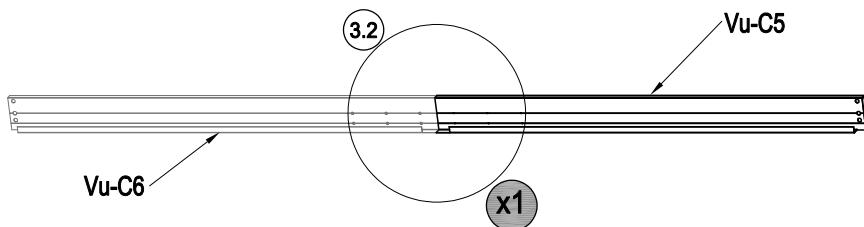
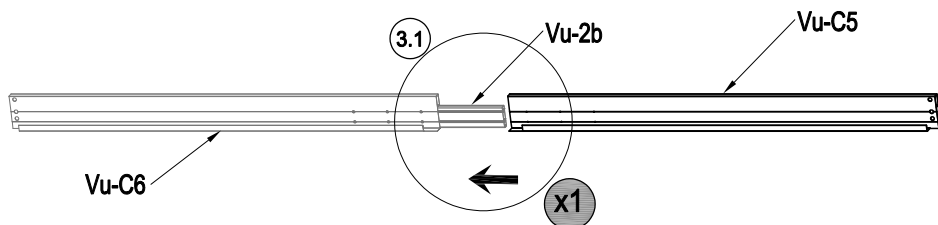





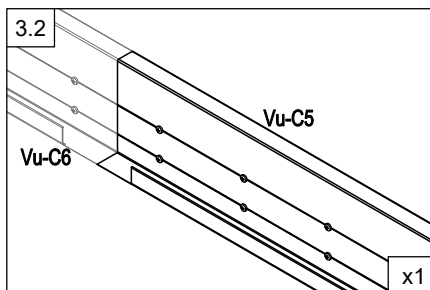
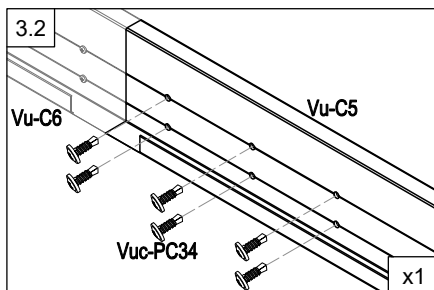

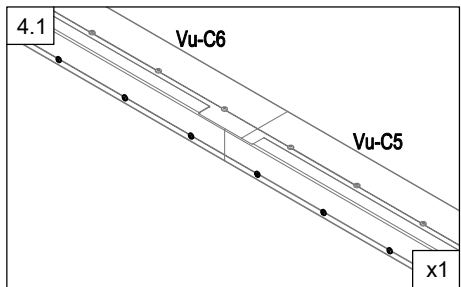
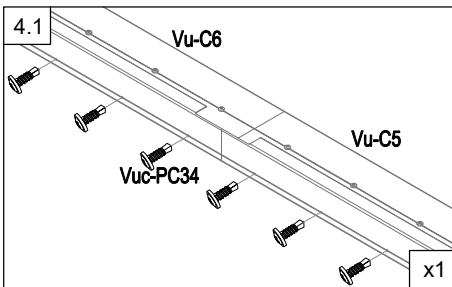
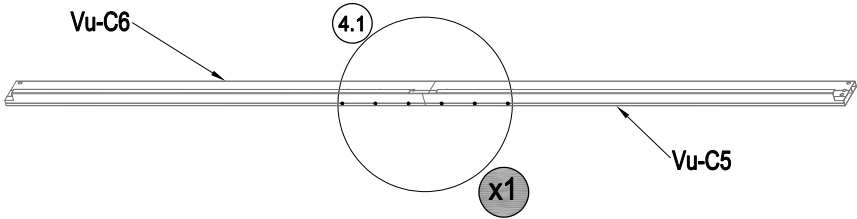
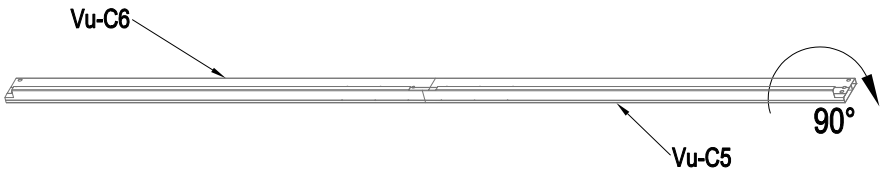
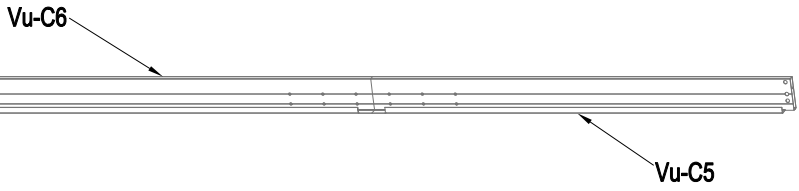
	Vu-C5	1
	Vuc-PC34	6



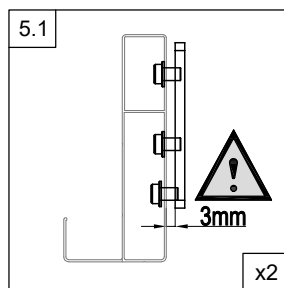
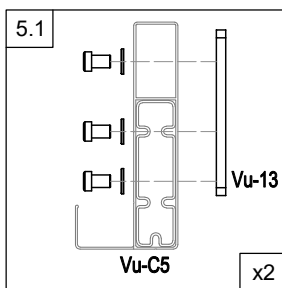
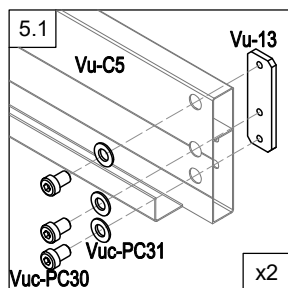
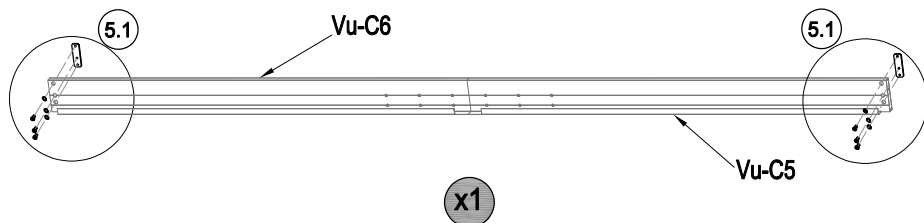





	Vuc-PC34	6
---	----------	---

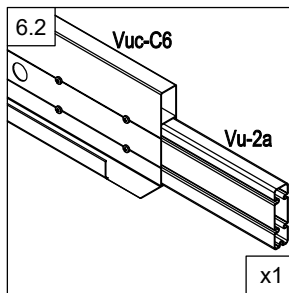
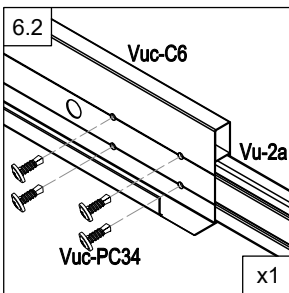
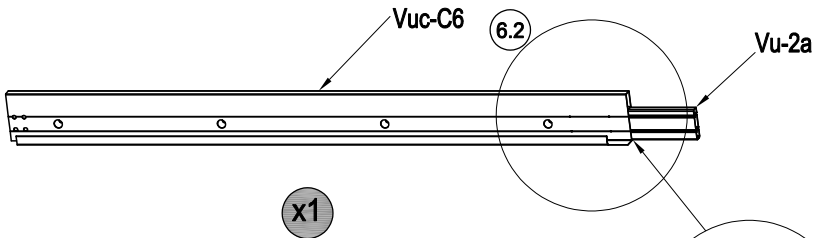
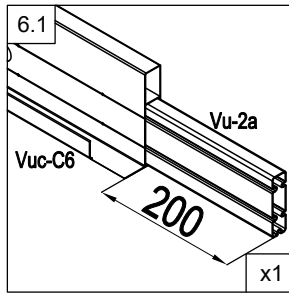
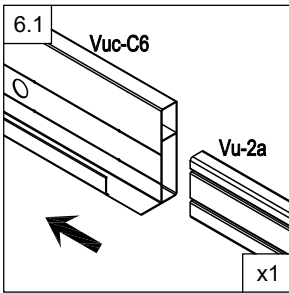
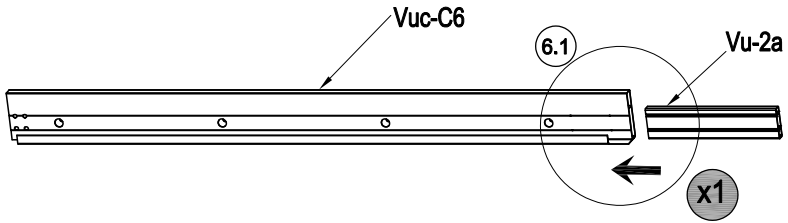



	Vu-13	2
	Vuc-PC30	6
	Vuc-PC31	6



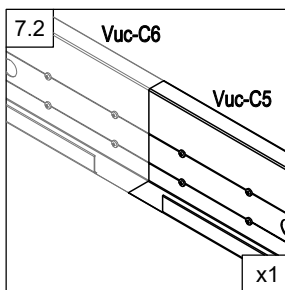
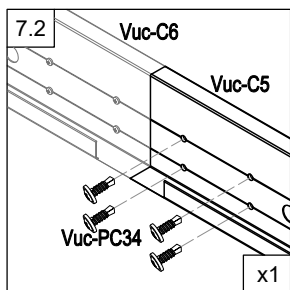
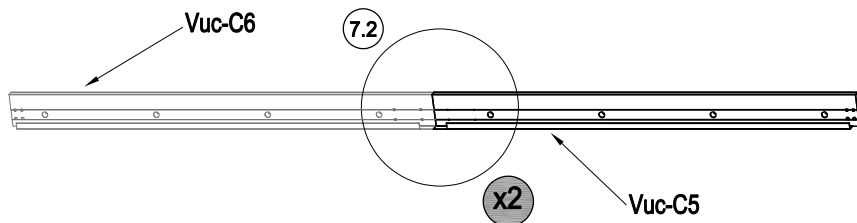
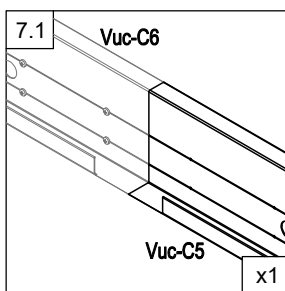
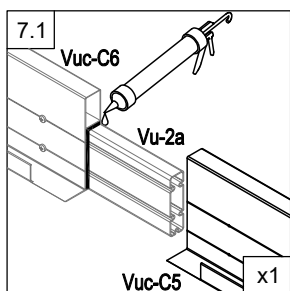
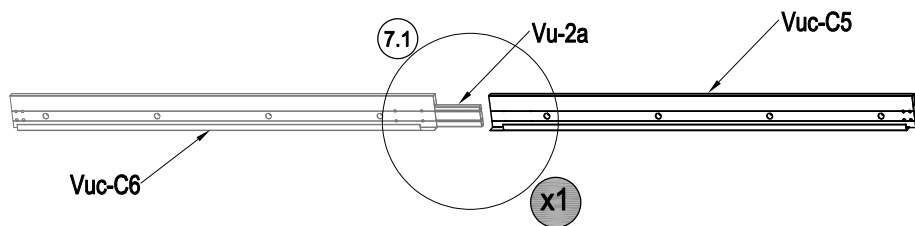

	Vuc-C6	1
	Vu-2a	1
	Vuc-PC34	4



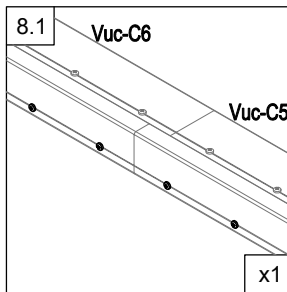
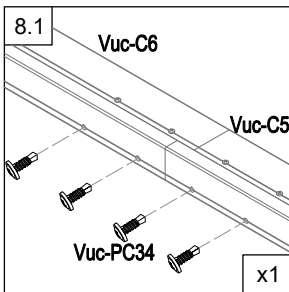
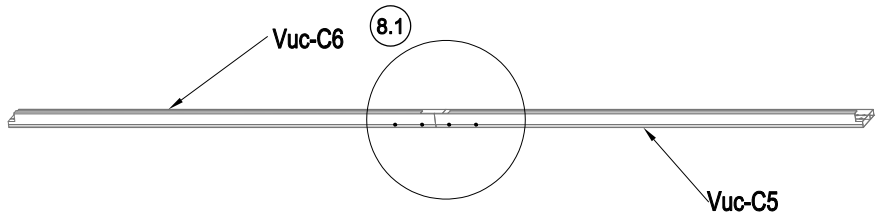
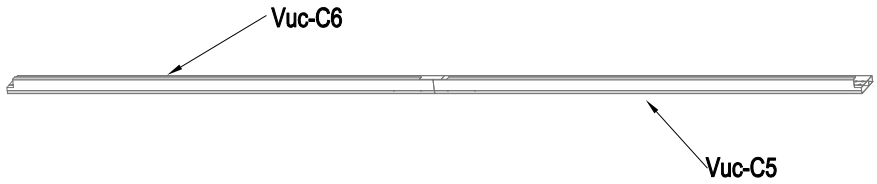
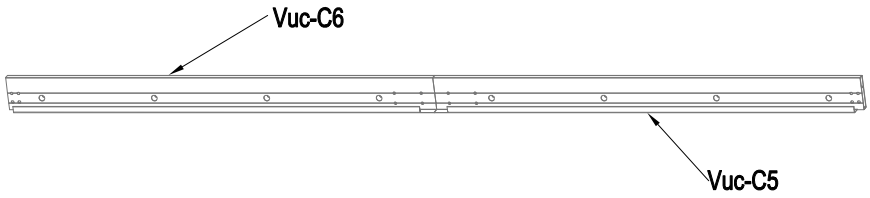

	Vuc-C5	1
	Vuc-PC34	4





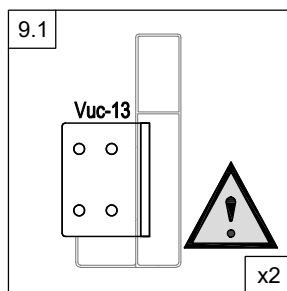
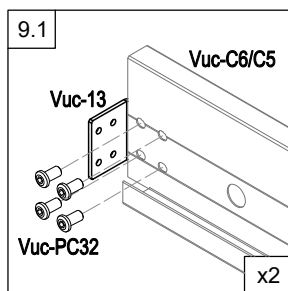
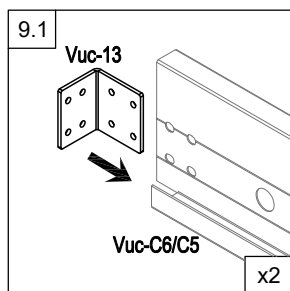
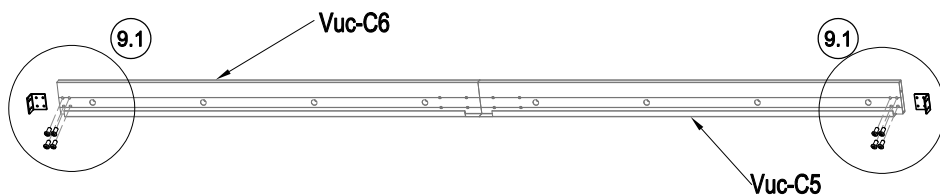



	Vuc-PC34	4
---	----------	---

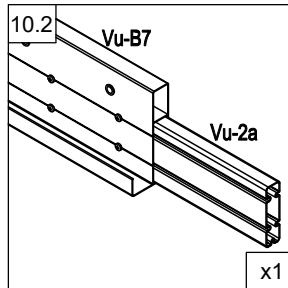
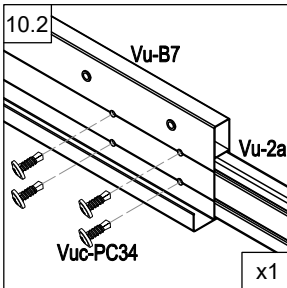
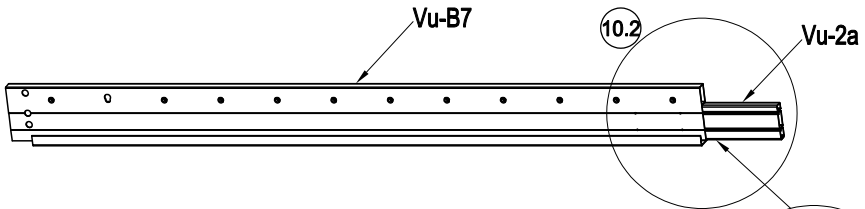
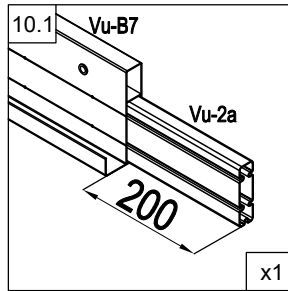
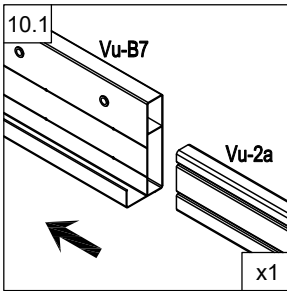
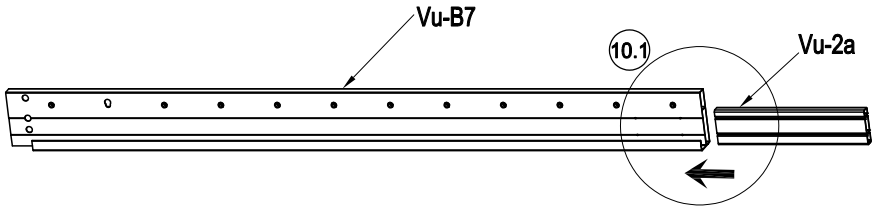



	Vu-13	2
	Vuc-PC32	8

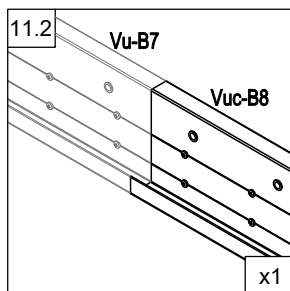
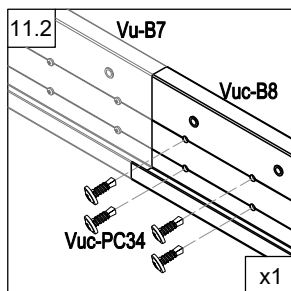
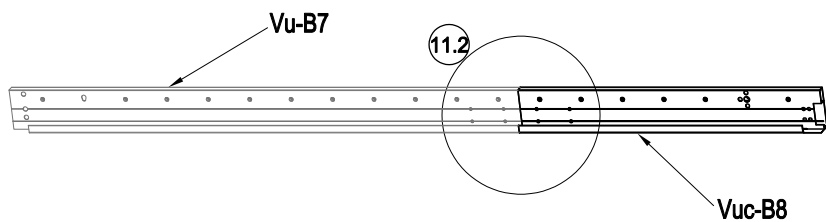
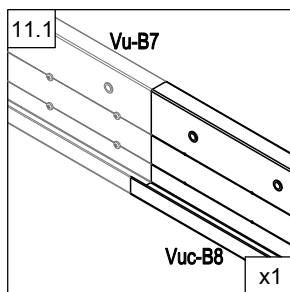
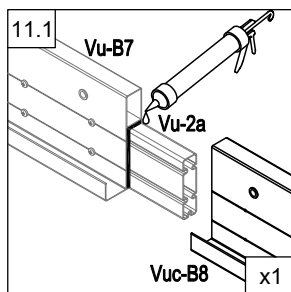
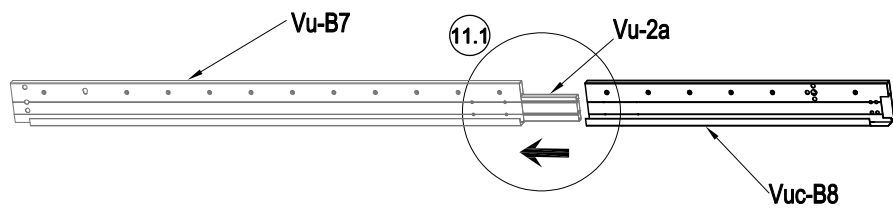

	Vu-B7	1
	Vu-2a	1
	Vuc-PC34	4



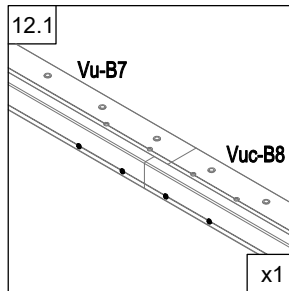
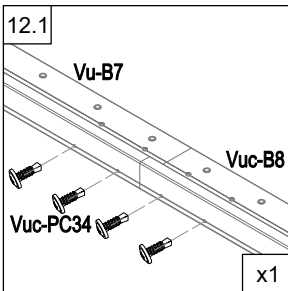
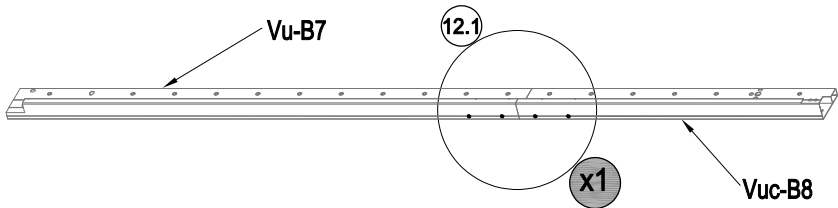
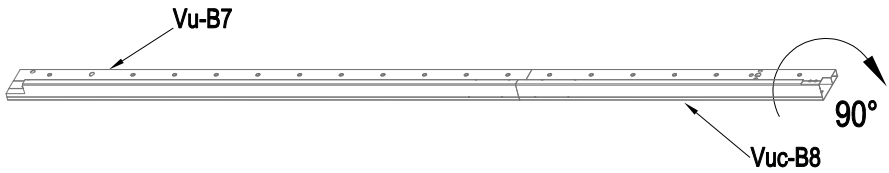
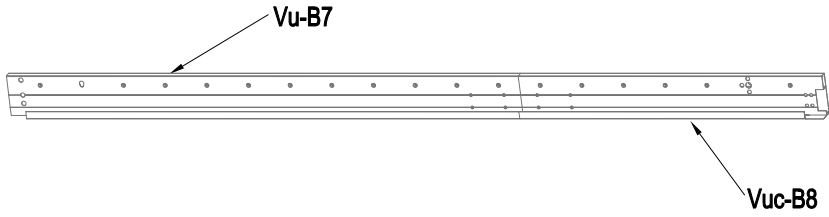

	Vuc-B8	1
	Vuc-PC34	4



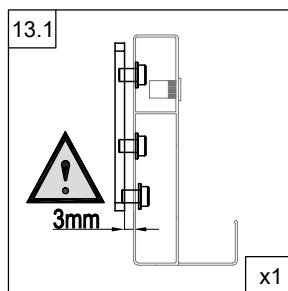
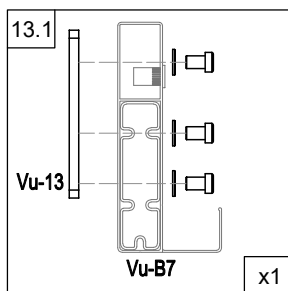
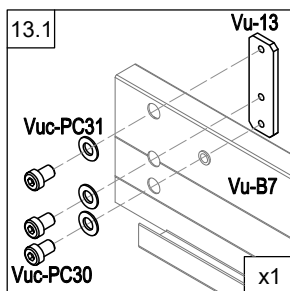
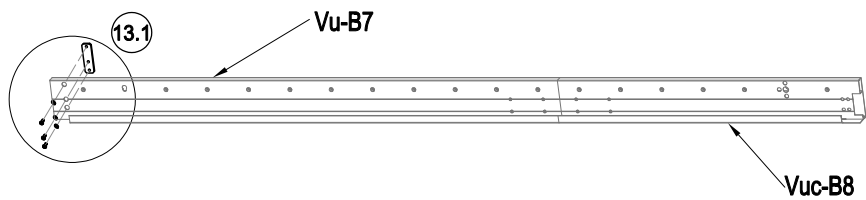

	Vuc-PC34	4
---	----------	---



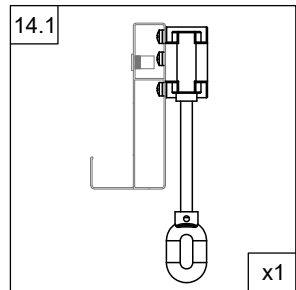
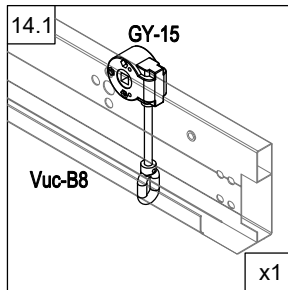
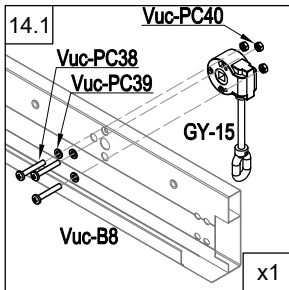
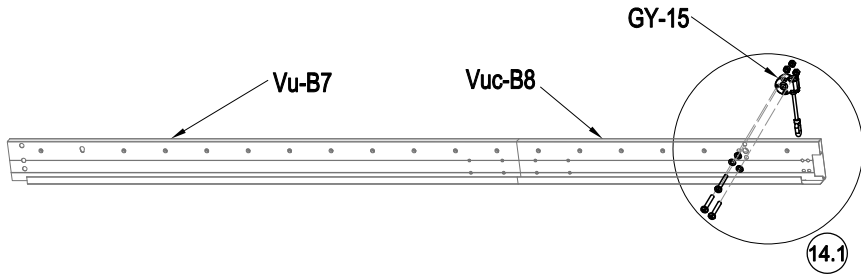

	Vu-13	1
	Vuc-PC30	3
	Vuc-PC31	3



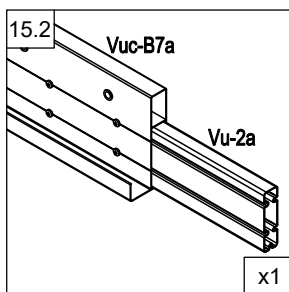
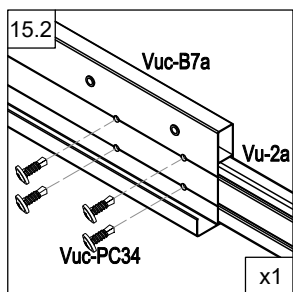
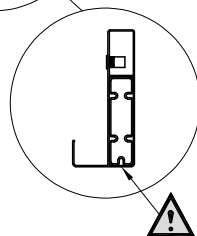
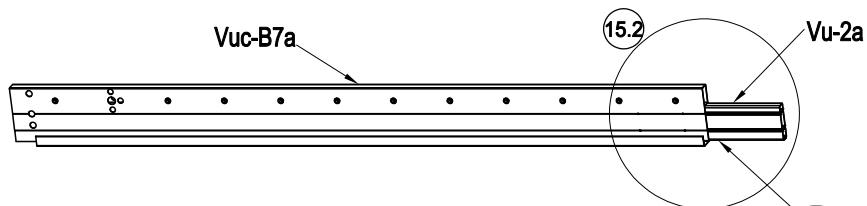
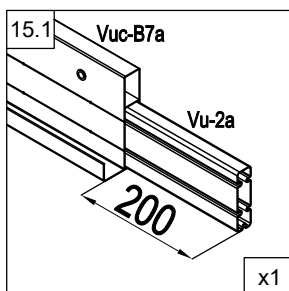
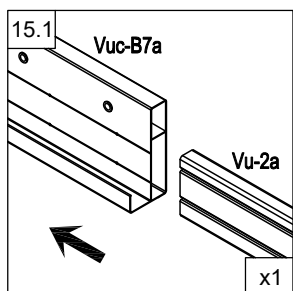
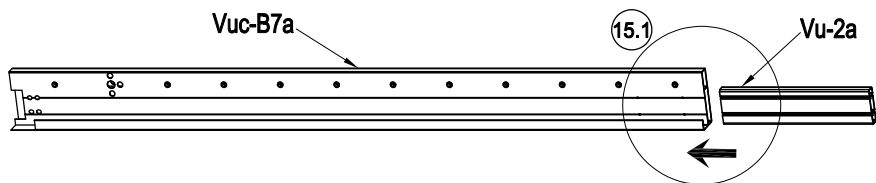

	GY-15	1		Vuc-PC39	3
	Vuc-PC38	3		Vuc-PC40	3



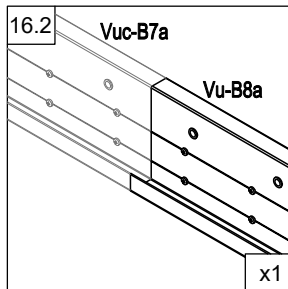
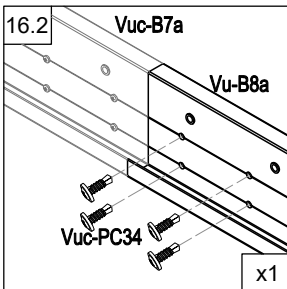
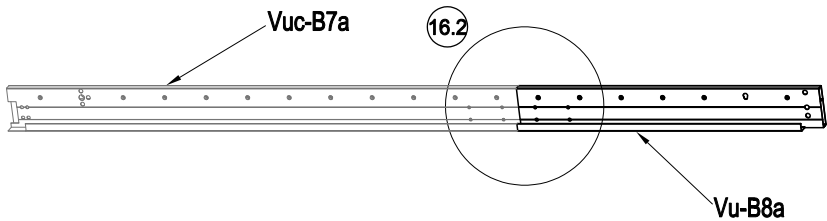
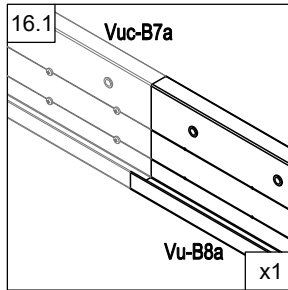
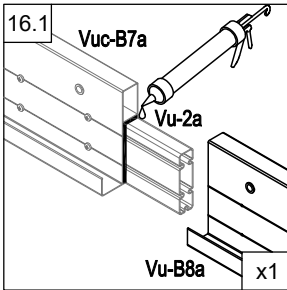
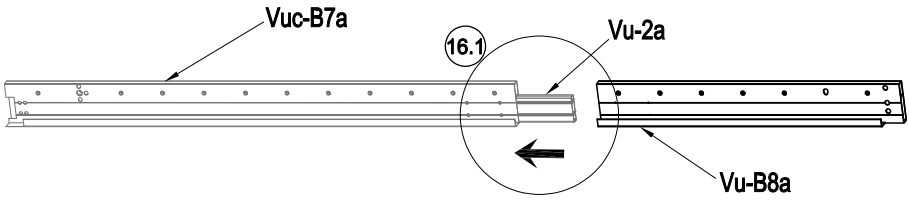

	Vuc-B7a	1
	Vu-2a	1
	Vuc-PC34	4





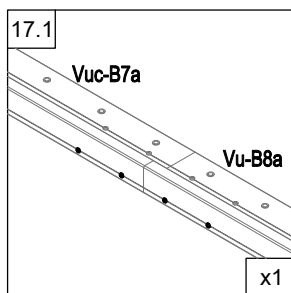
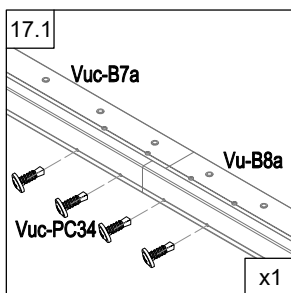
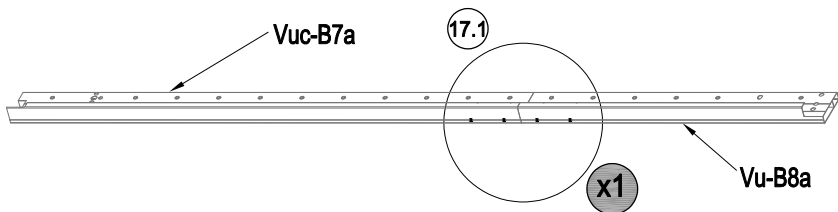
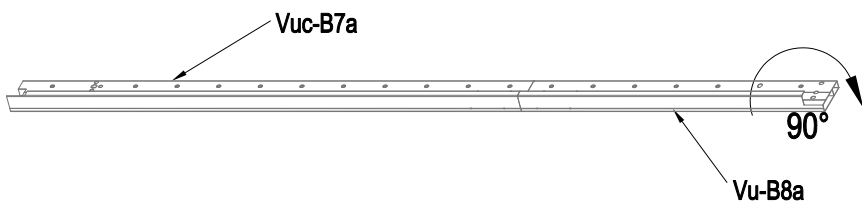
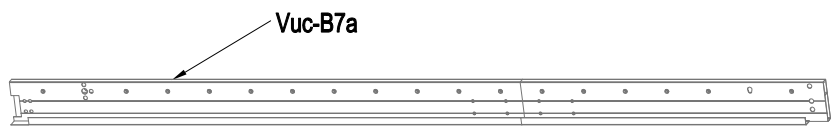



	Vu-B8a	1
	Vuc-PC34	4

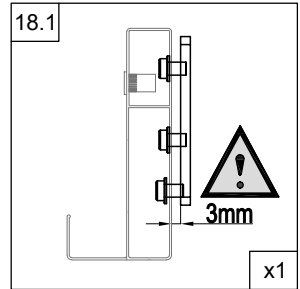
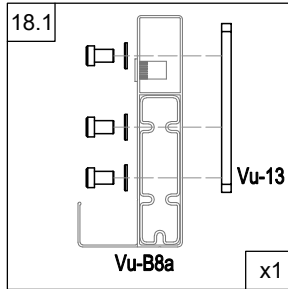
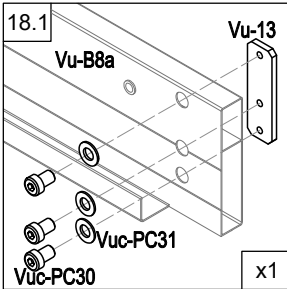
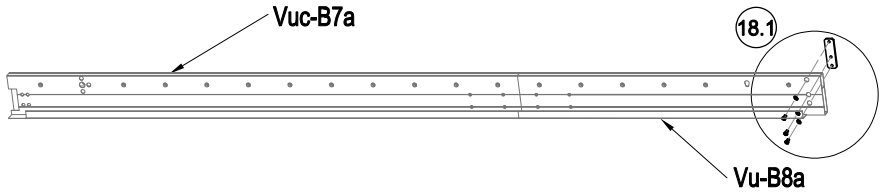





	Vuc-PC34	4
---	----------	---

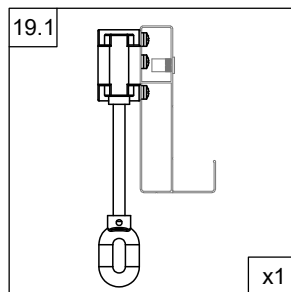
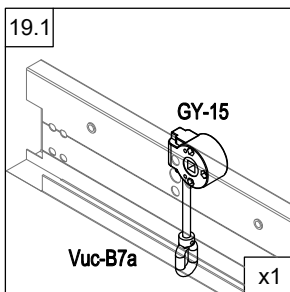
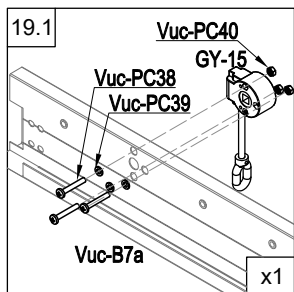
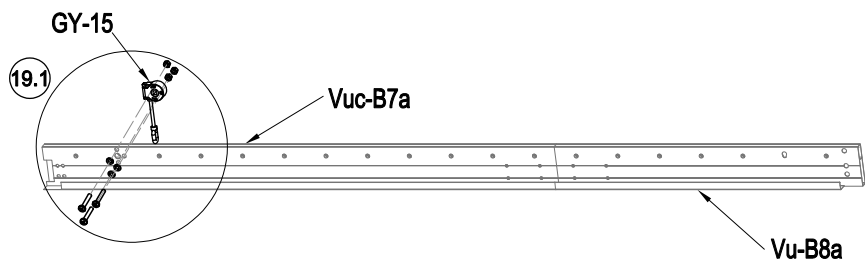



	Vu-13	1
	Vuc-PC30	3
	Vuc-PC31	3



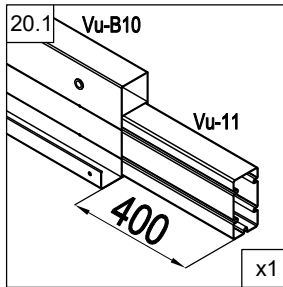
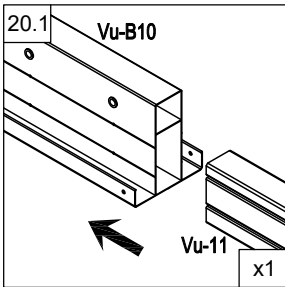
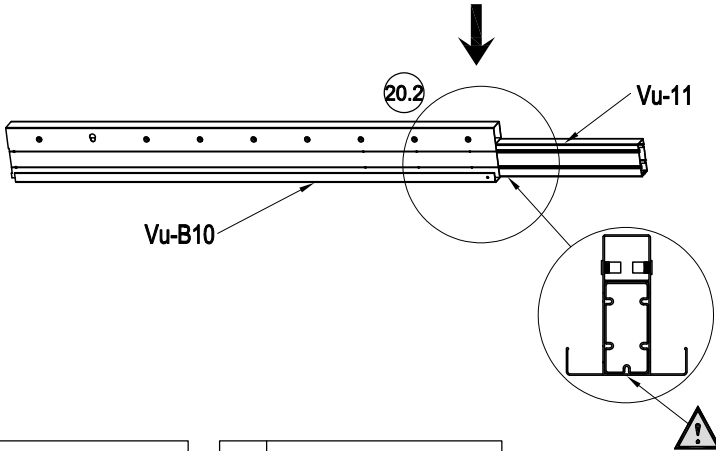
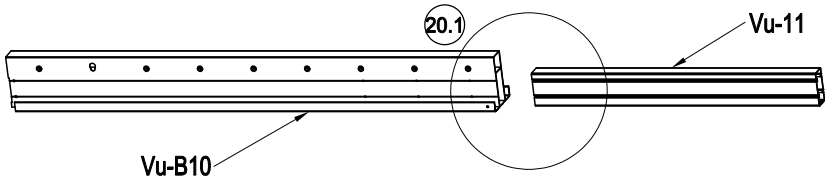

	<b>GY-15</b>	1		<b>Vuc-PC39</b>	3
	<b>Vuc-PC38</b>	3		<b>Vuc-PC40</b>	3

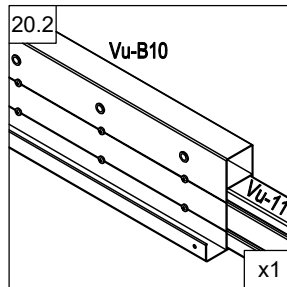
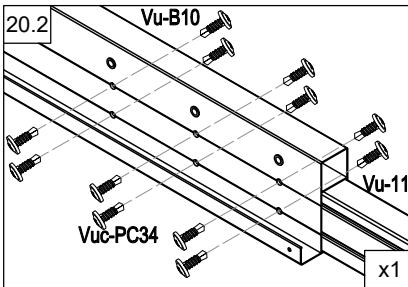

	Vu-B10	1
	Vu-11	1
	Vu-PC34	12

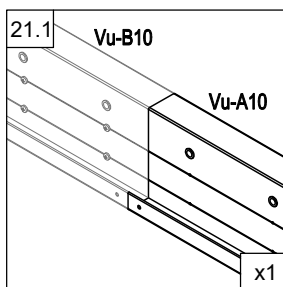
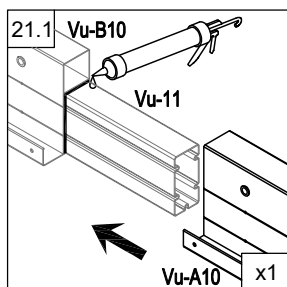
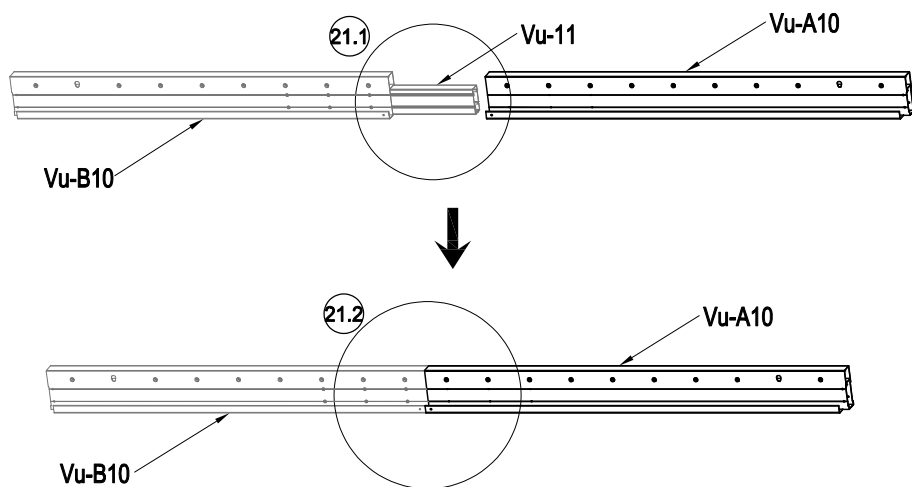



	Vu-A10	1
	VuC-PC34	12

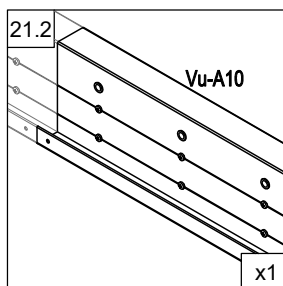
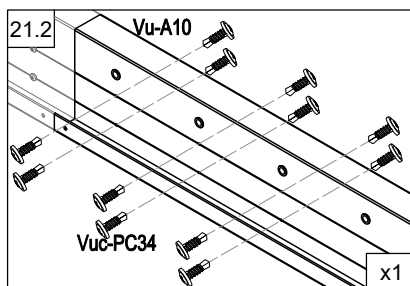

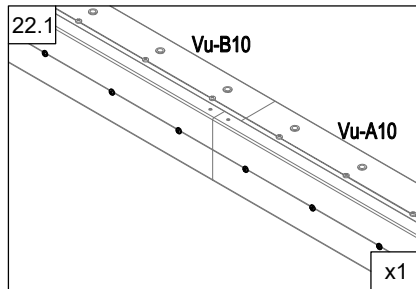
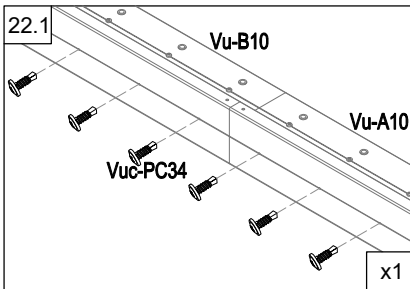
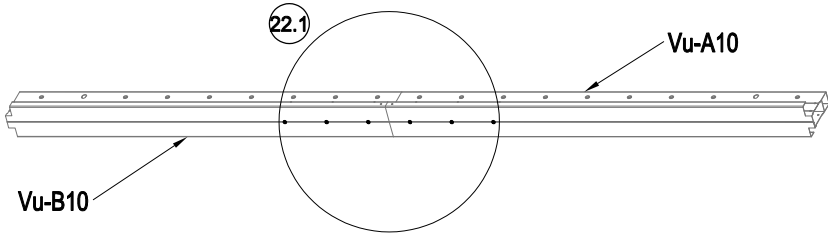
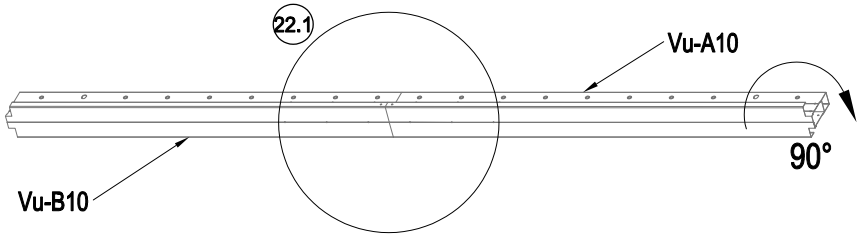
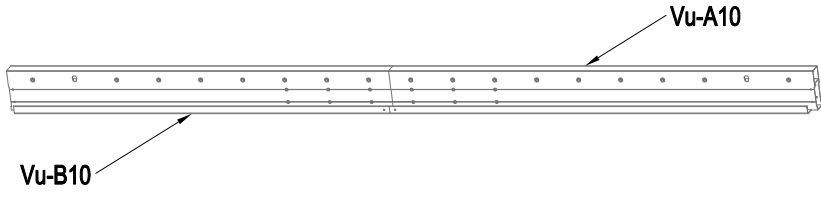

	VuC-PC34	6
---	----------	---

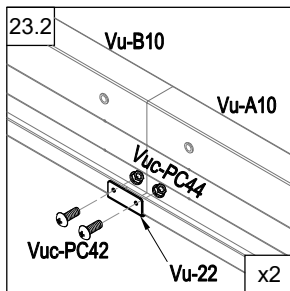
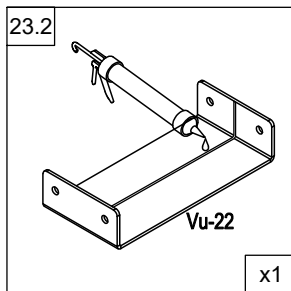
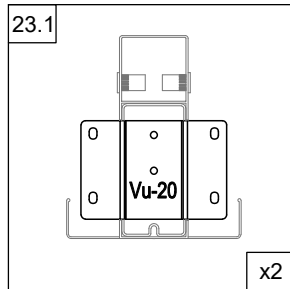
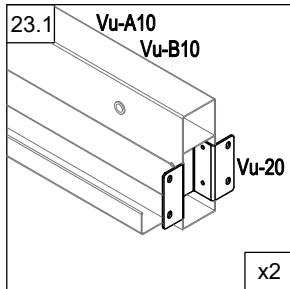
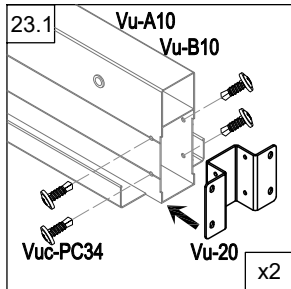
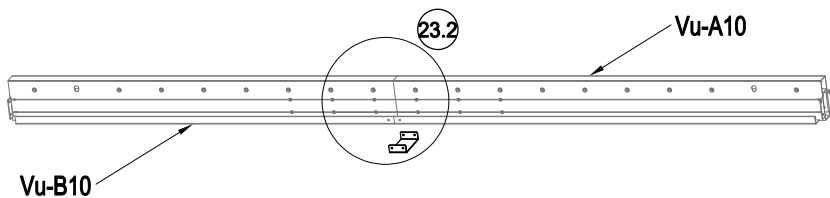
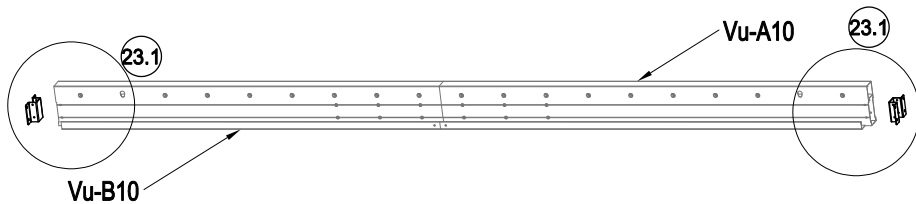

	Vu-20	2
	Vu-22	1
	Vuc-PC34	8
	Vuc-PC42	4
	Vuc-PC44	4



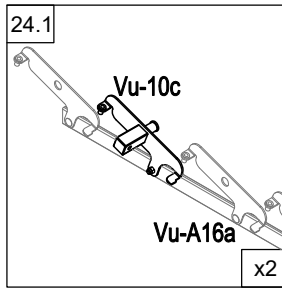
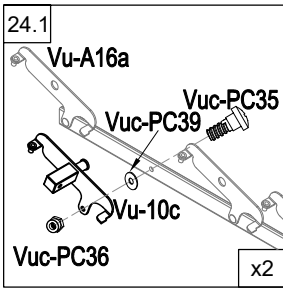
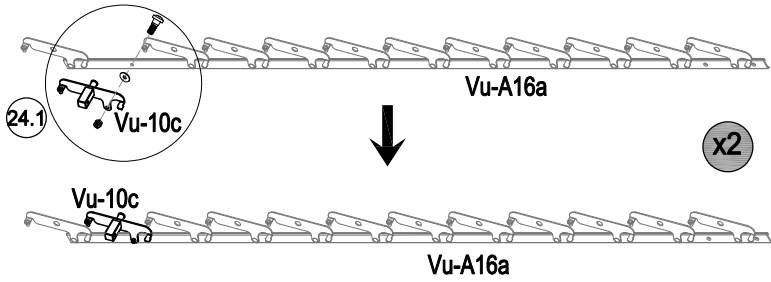

	Vu-A16a	2
	Vu-10c	2
	Vuc-PC35	2
	Vuc-PC36	2
	Vuc-PC39	2

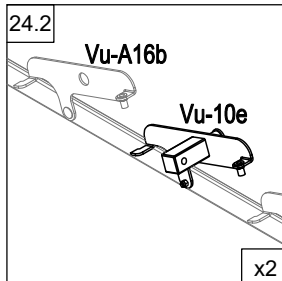
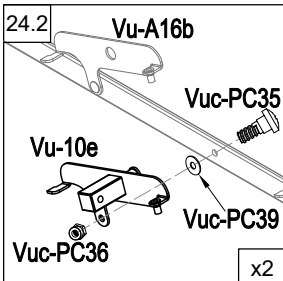
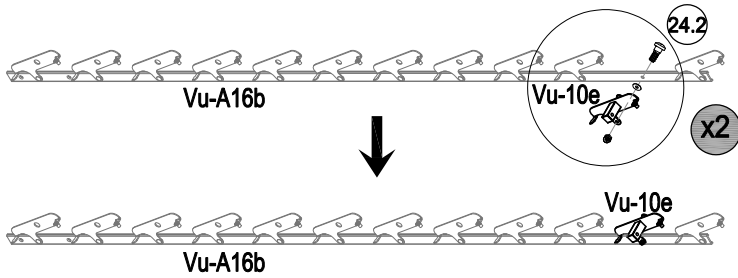

	Vu-A16b	2
	Vu-10e	2
	Vuc-PC35	2
	Vuc-PC36	2
	Vuc-PC39	2

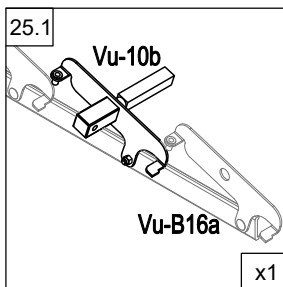
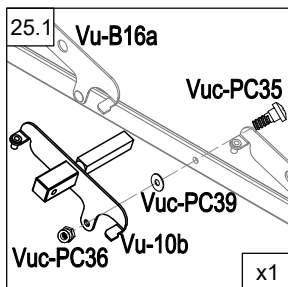
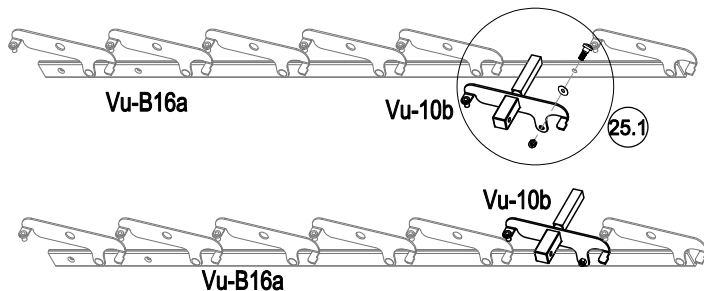



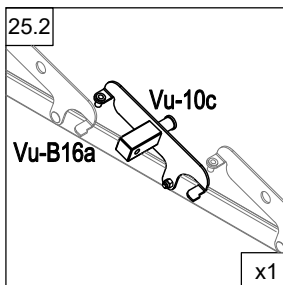
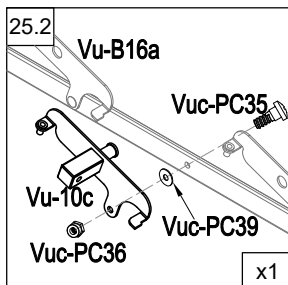
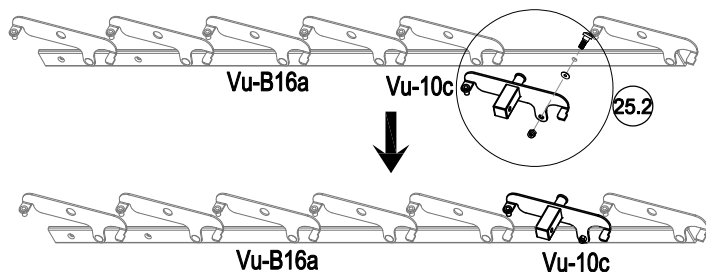

	Vu-B16a	1
	Vu-10b	1
	Vuc-PC35	1
	Vuc-PC36	1
	Vuc-PC39	1

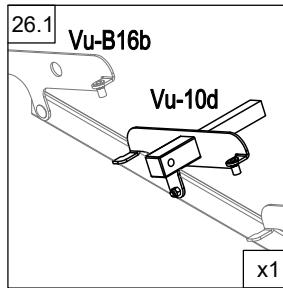
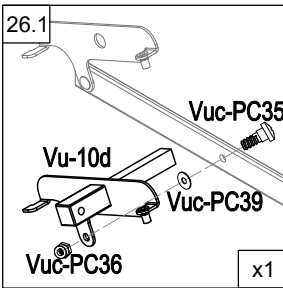
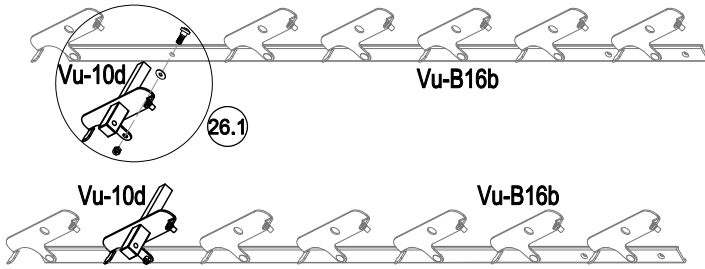

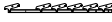



	Vu-B16a	1
	Vu-10c	1
	Vuc-PC35	1
	Vuc-PC36	1
	Vuc-PC39	1

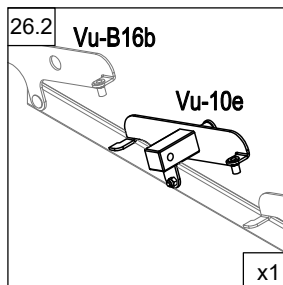
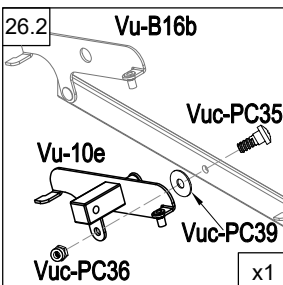
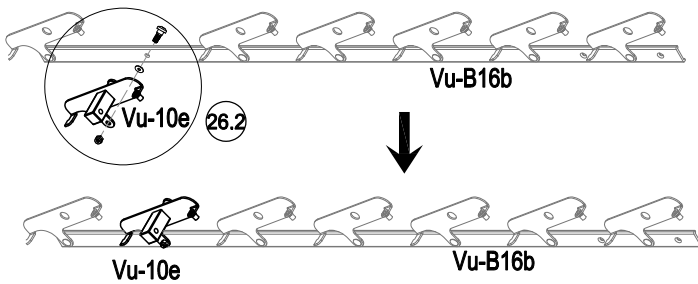



	Vu-B16b	1
	Vu-10d	1
	VuC-PC35	1
	VuC-PC36	1
	VuC-PC39	1

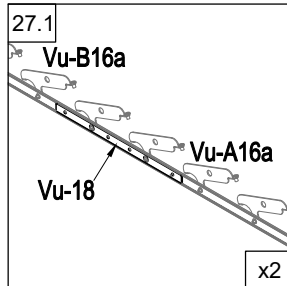
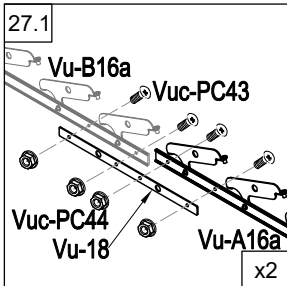
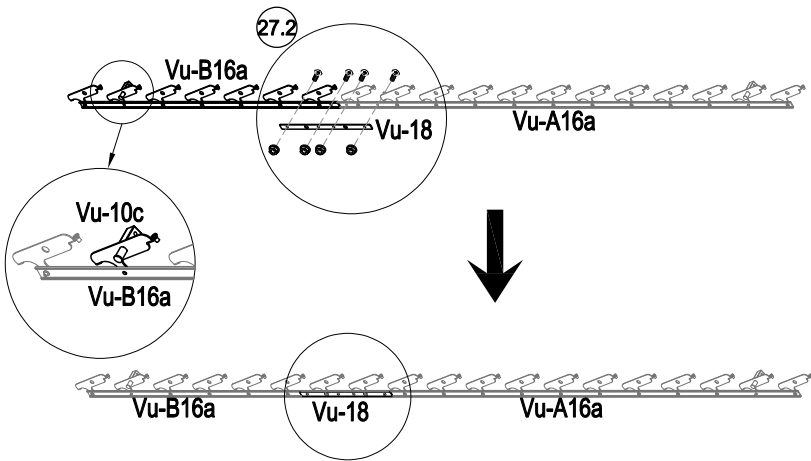
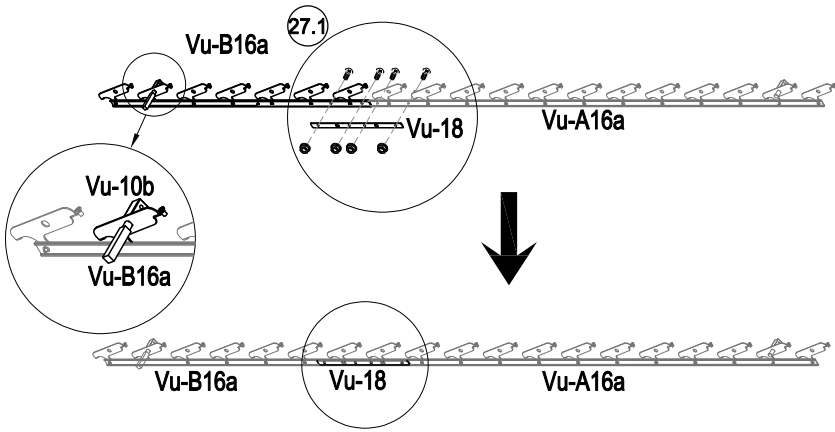

	Vu-B16b	1
	Vu-10e	1
	VuC-PC35	1
	VuC-PC36	1
	VuC-PC39	1



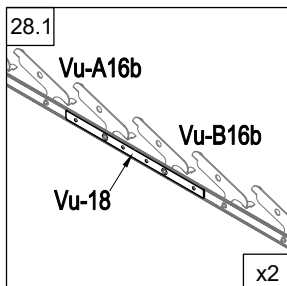
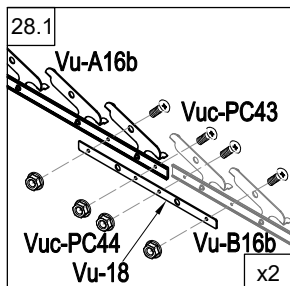
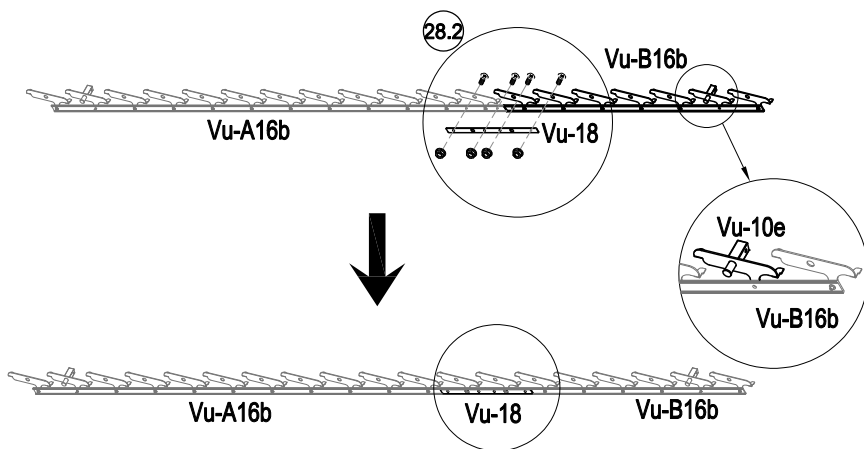
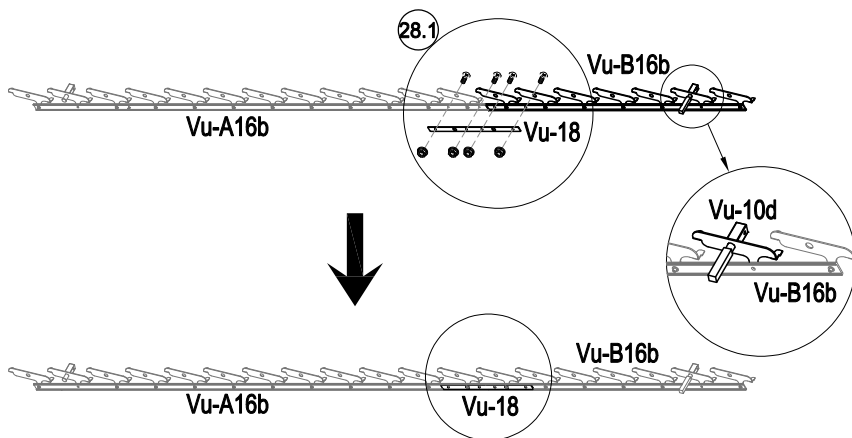

	Vu-18	2
	Vuc-PC43	8
	Vuc-PC44	8



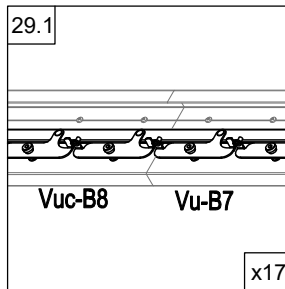
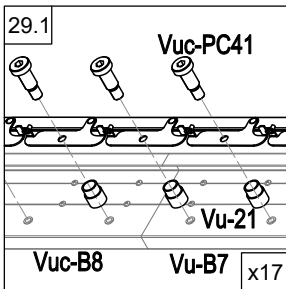
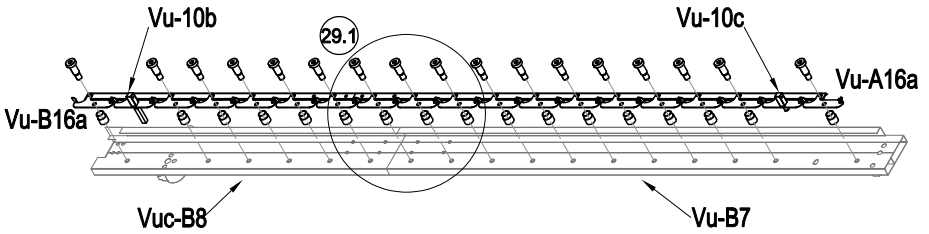

	Vu-18	2
	Vuc-PC43	8
	Vuc-PC44	8



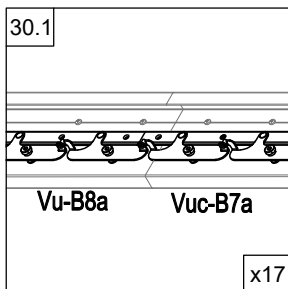
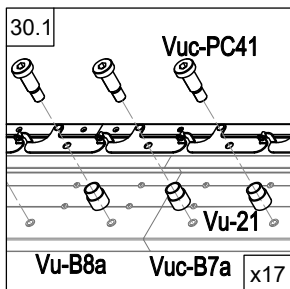
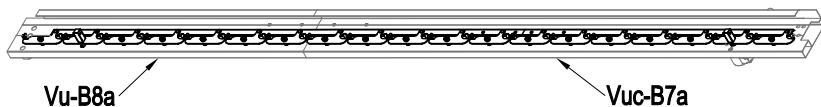
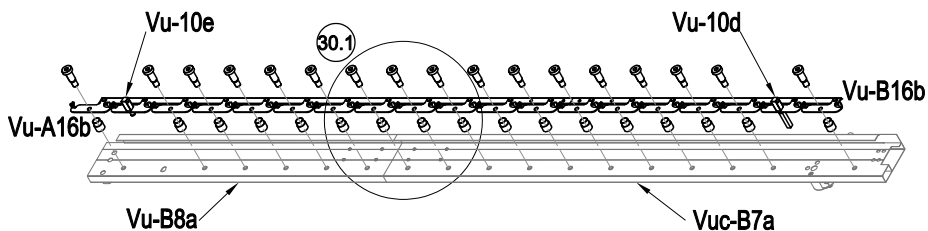

	Vu-21	17
	Vuc-PC41	17



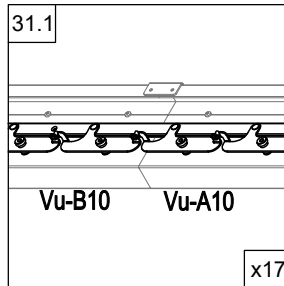
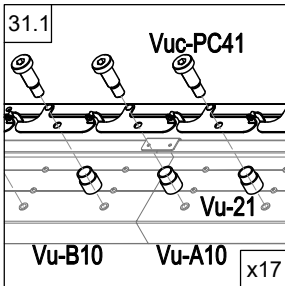
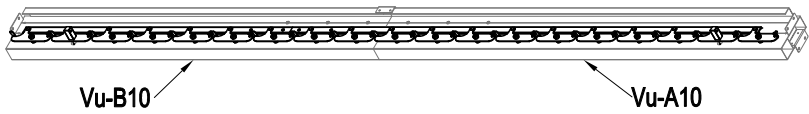
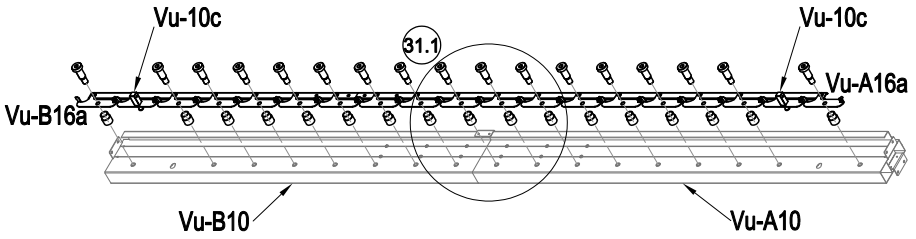

	Vu-21	17
	Vuc-PC41	17



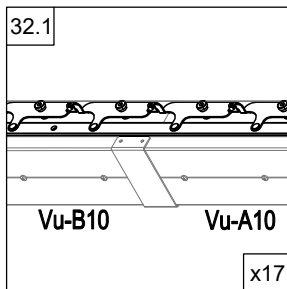
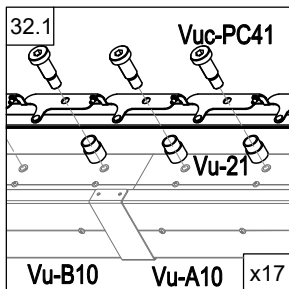
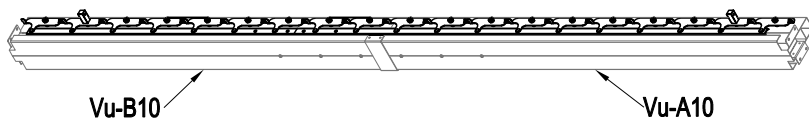
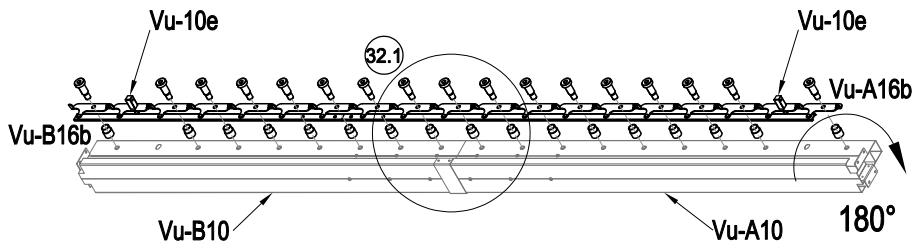

	Vu-21	17
	Vuc-PC41	17





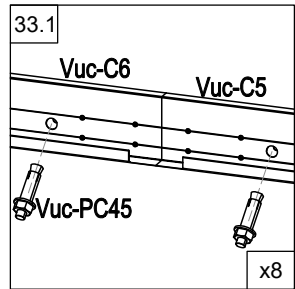
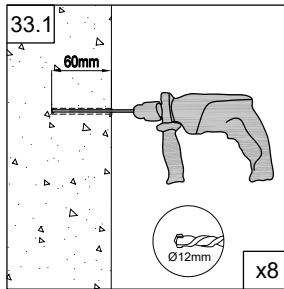
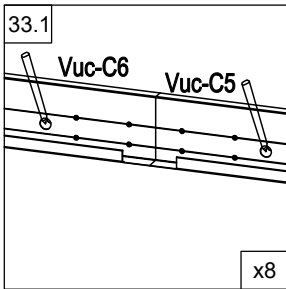
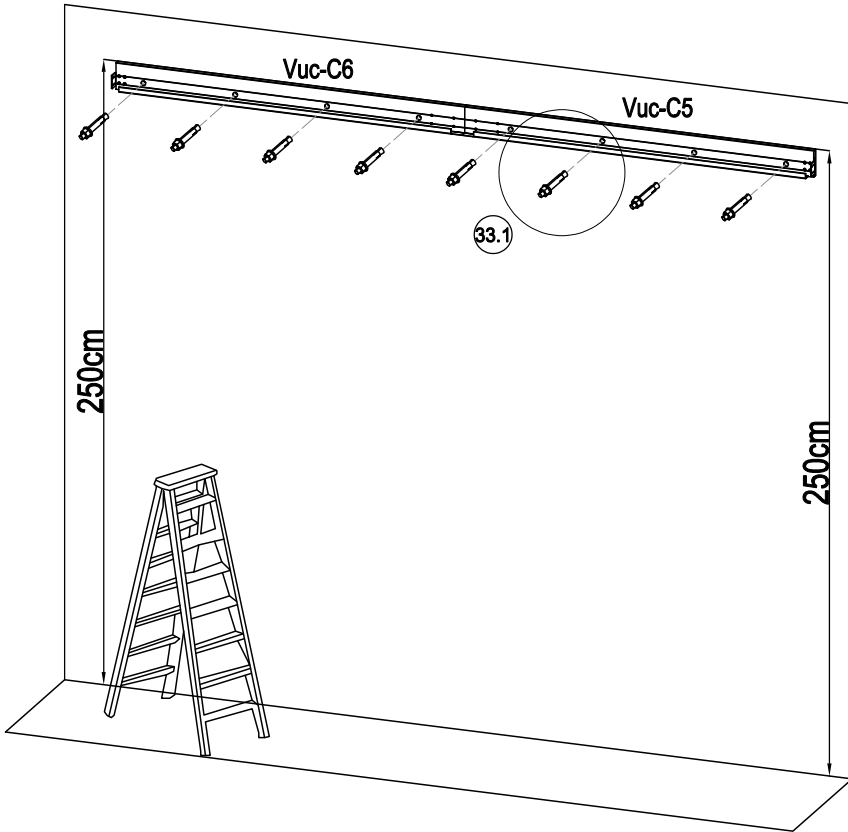

	Vu-21	17
	Vuc-PC41	17

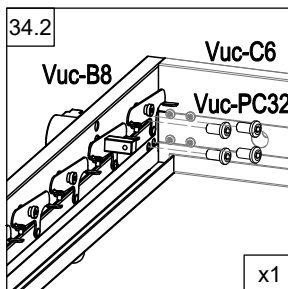
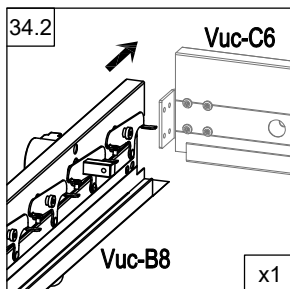
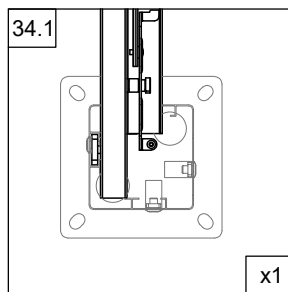
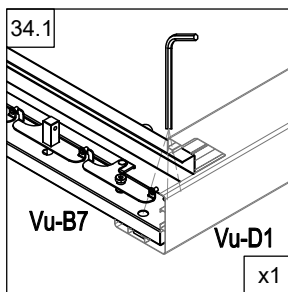
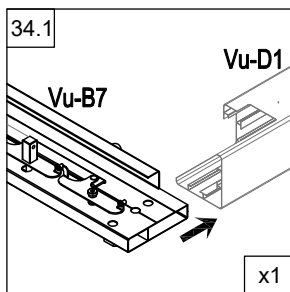
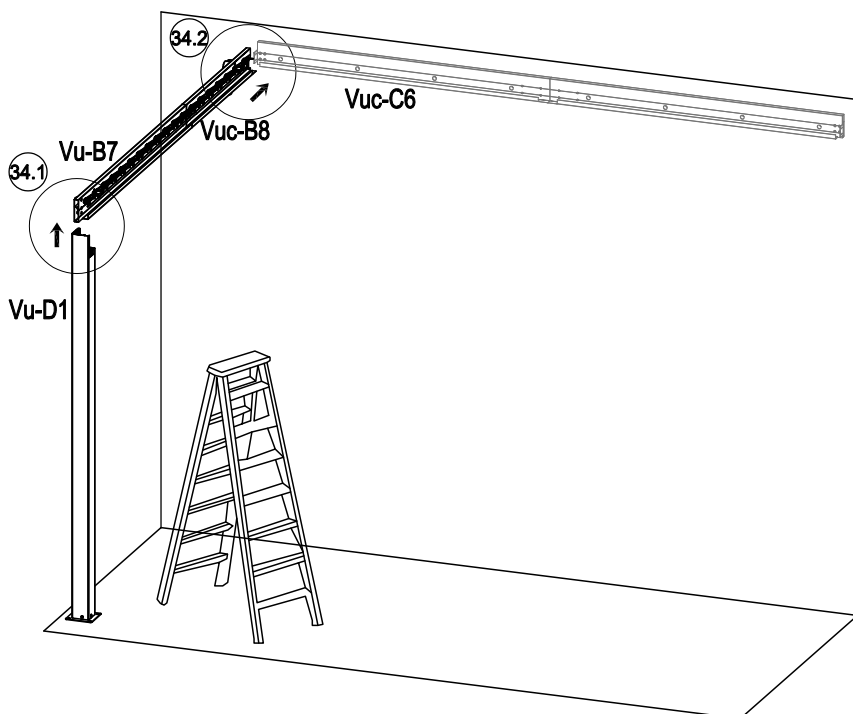

	Vuc-PC45	8
---	----------	---



	Vuc-PC32	4
---	----------	---

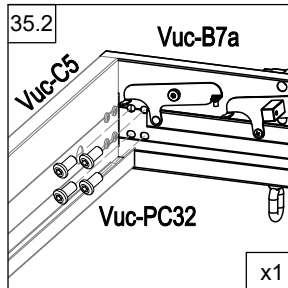
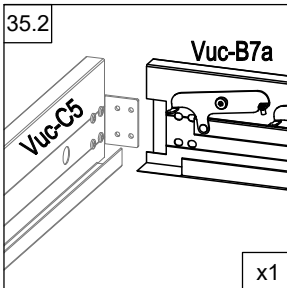
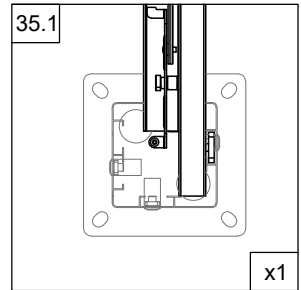
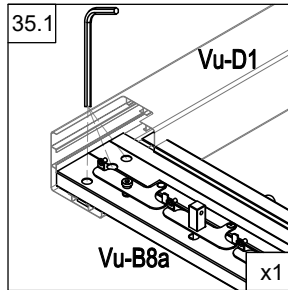
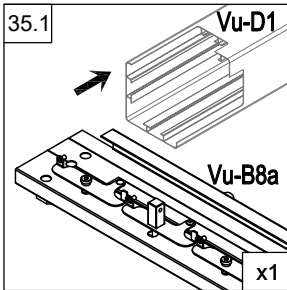
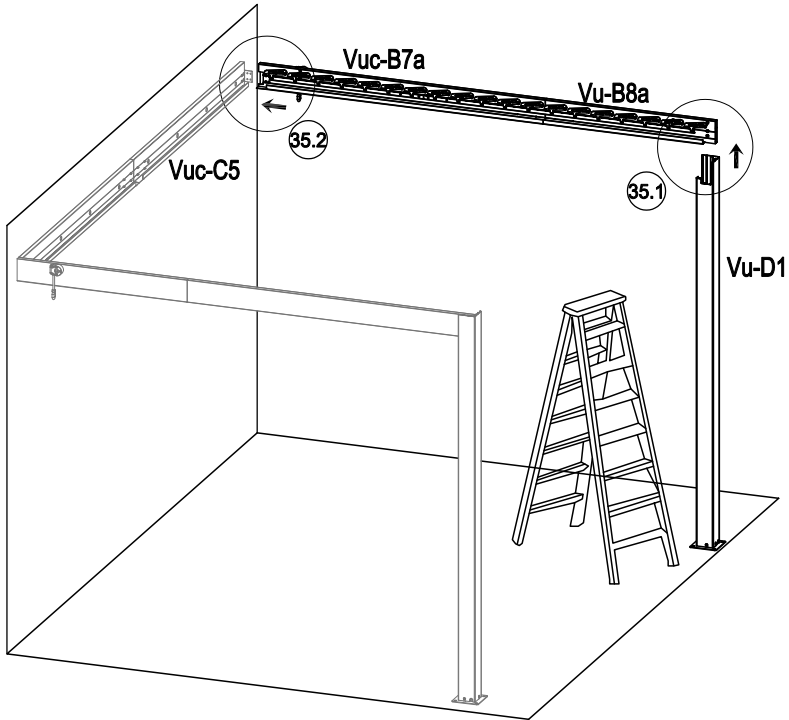

	Vuc-PC32	4
---	----------	---

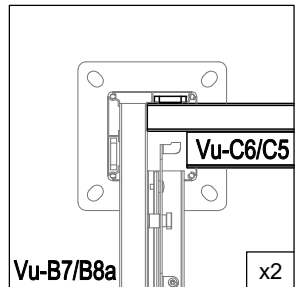
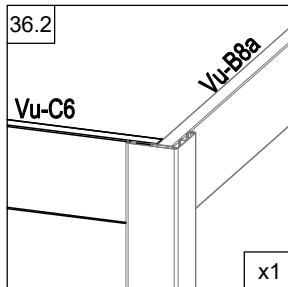
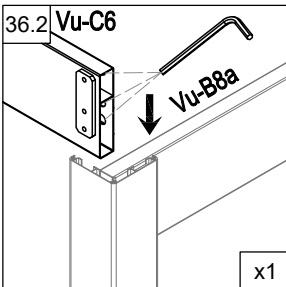
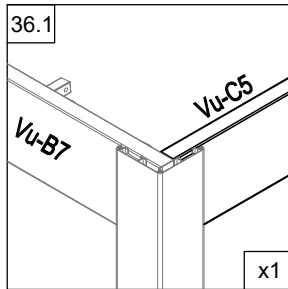
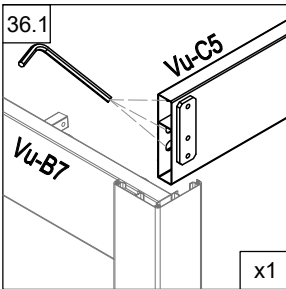
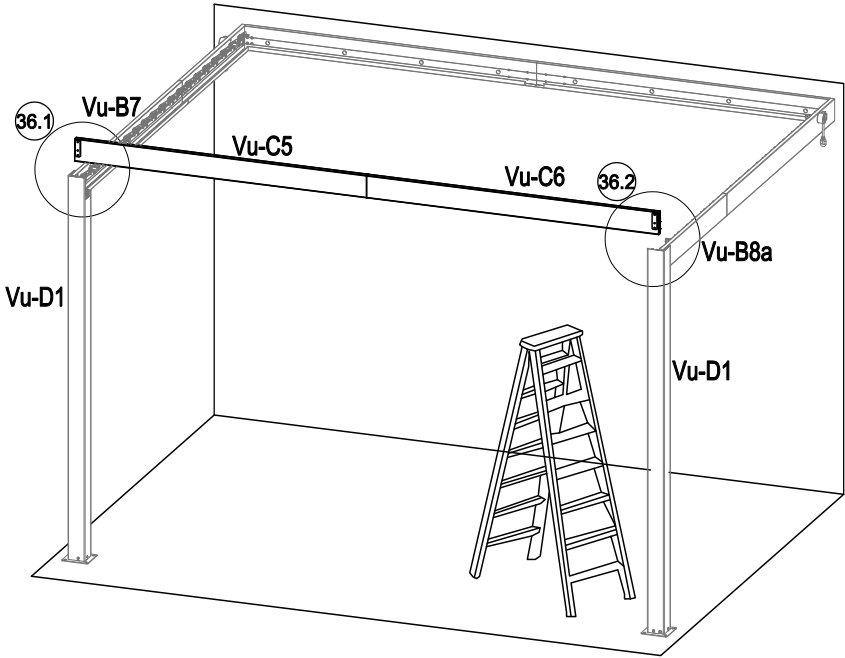

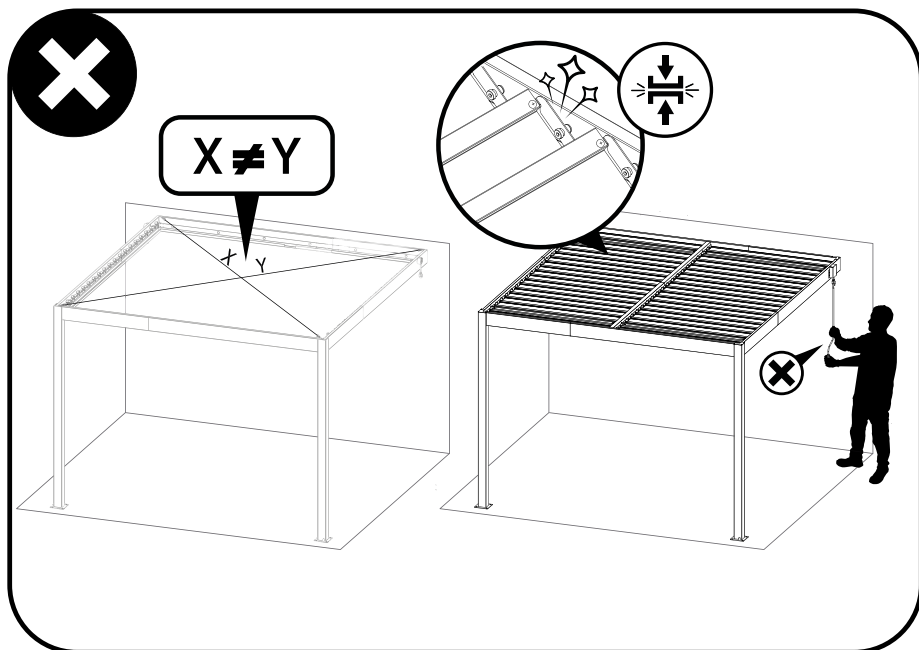
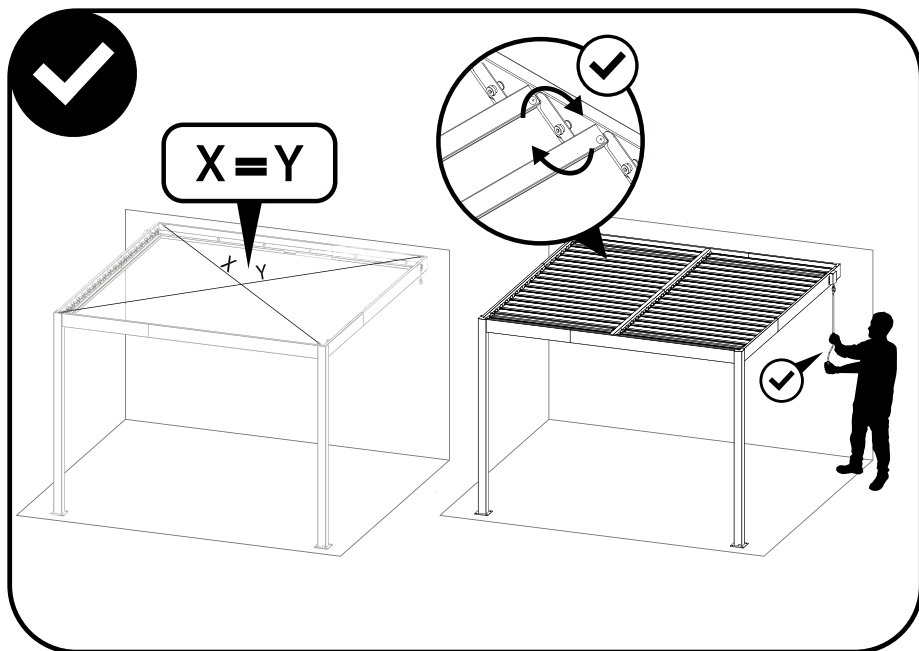

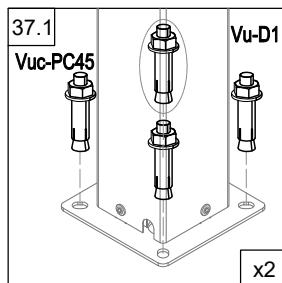
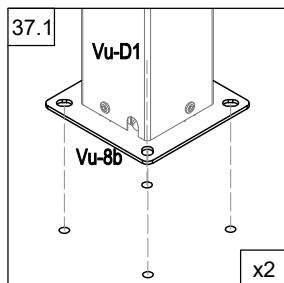
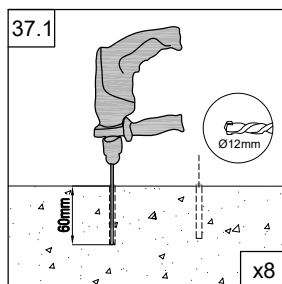
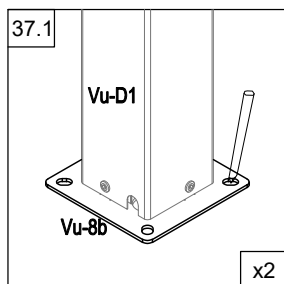
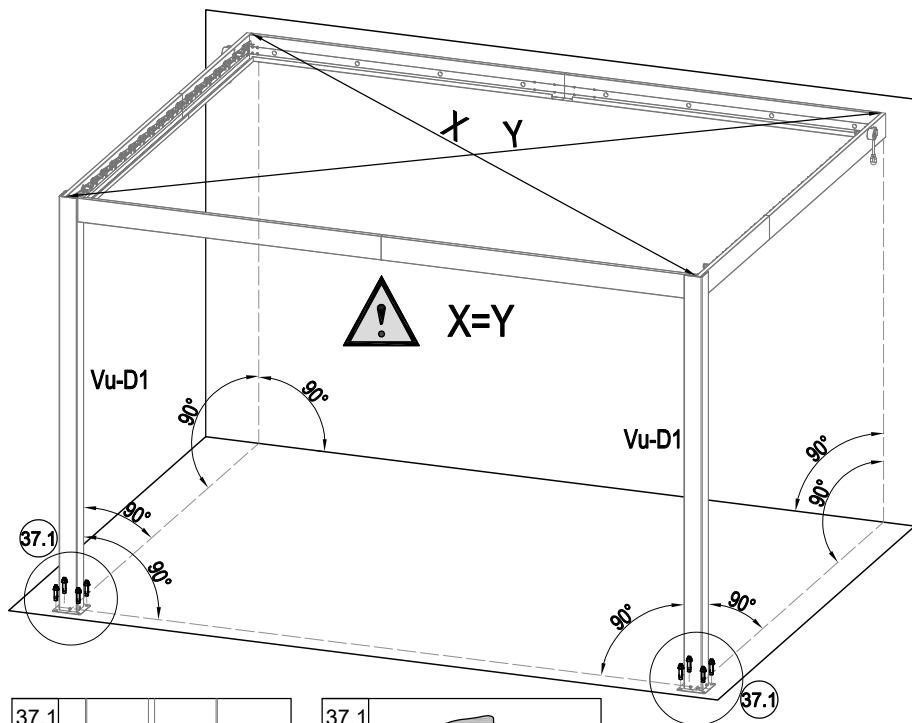

	Vuc-PC45	8
---	----------	---

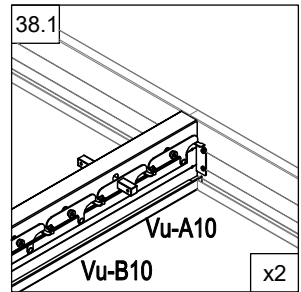
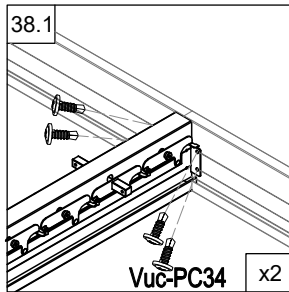
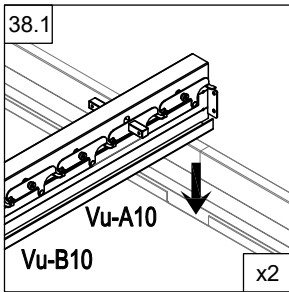
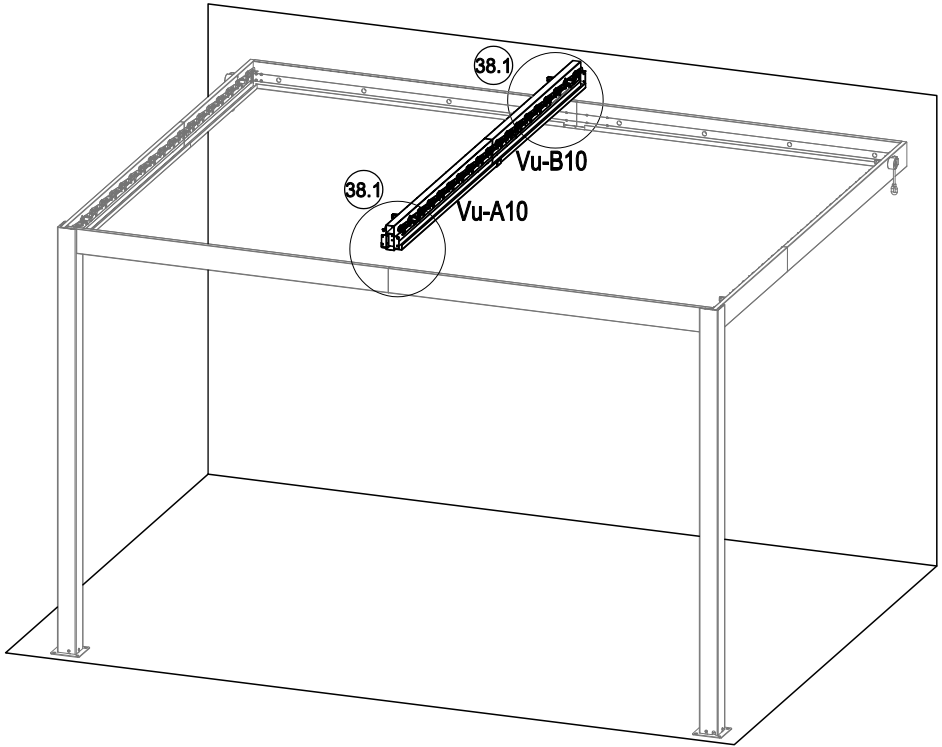



	Vu-PC34	8
---	---------	---

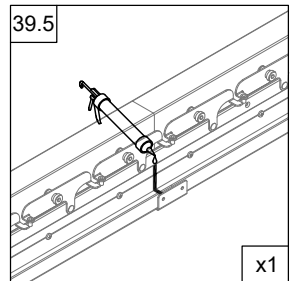
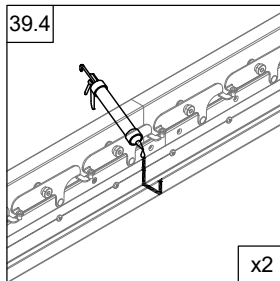
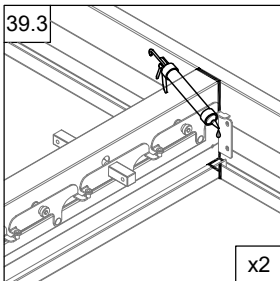
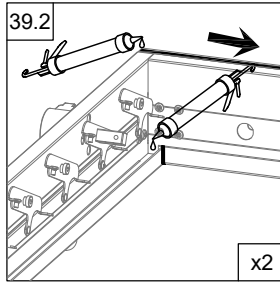
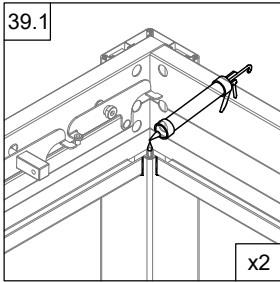
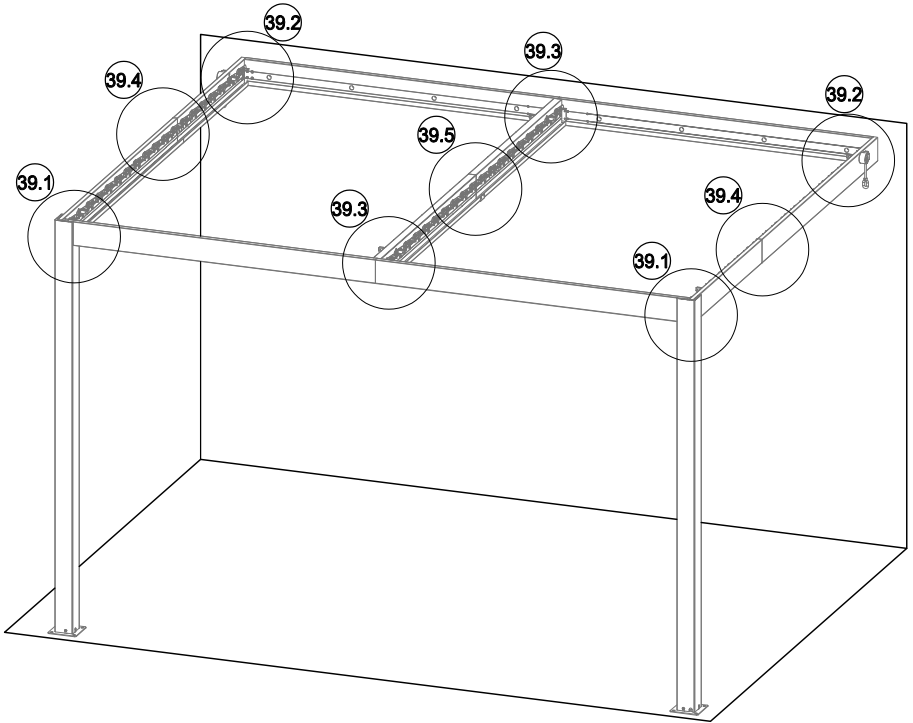

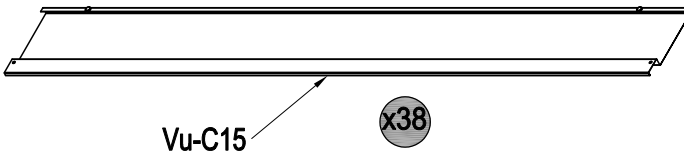
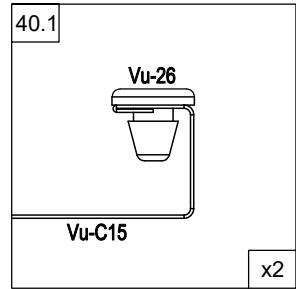
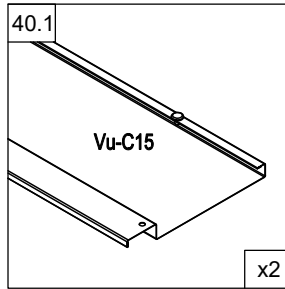
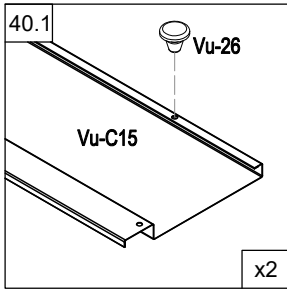
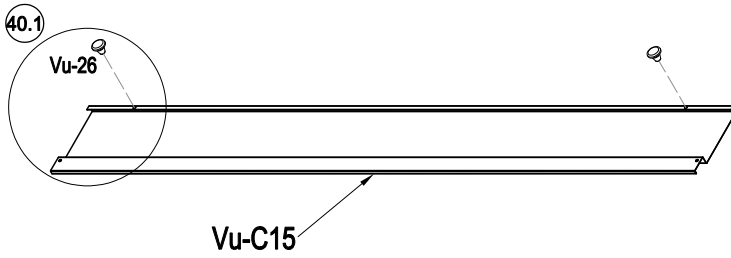



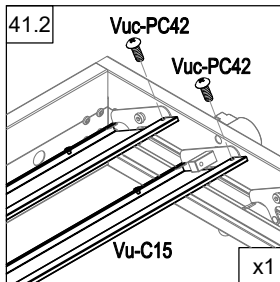
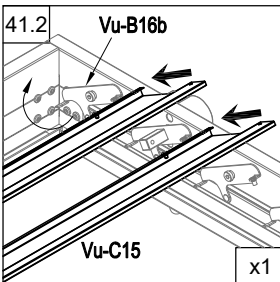
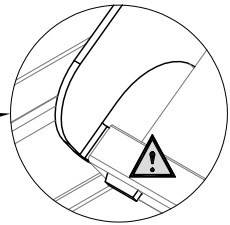
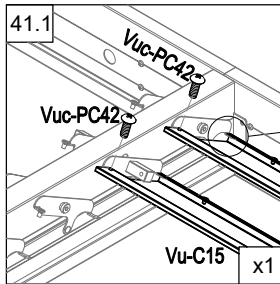
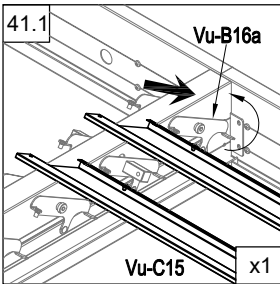
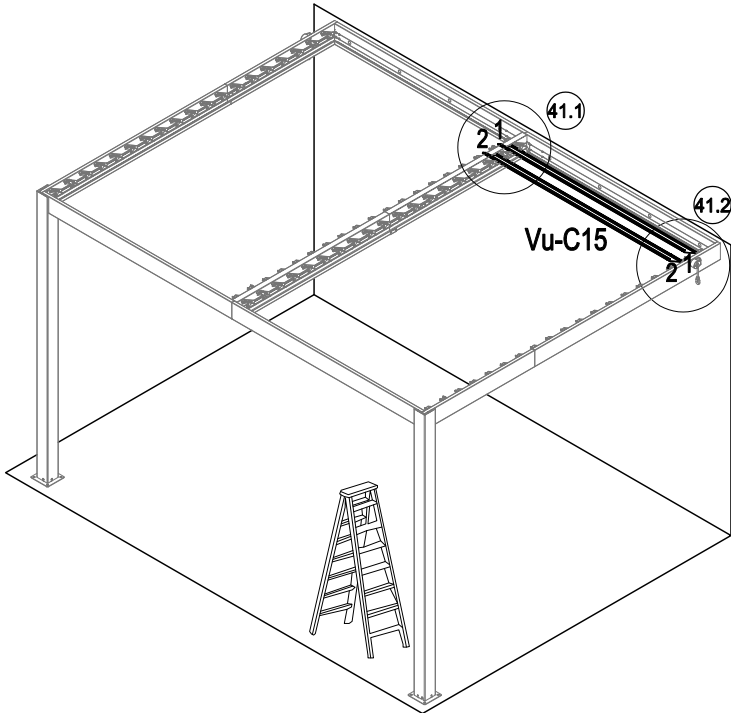

	Vu-C15	38
	Vu-26	76

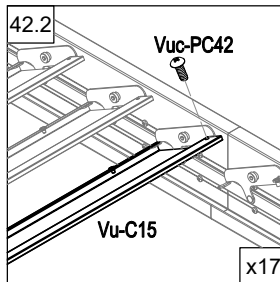
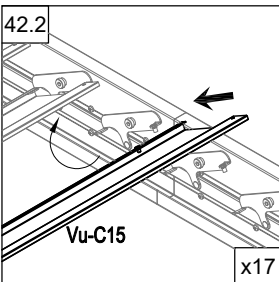
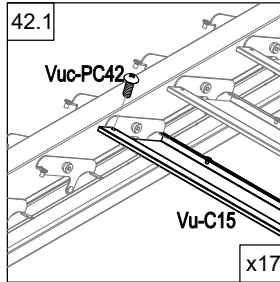
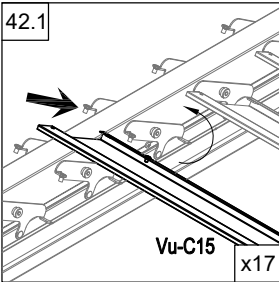
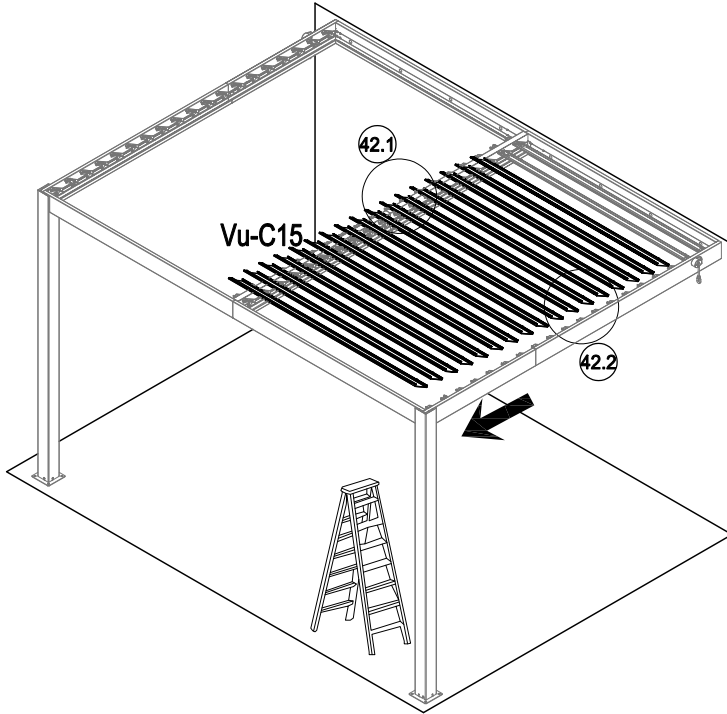

	Vu-C-PC42	4
---	-----------	---



	Vuc-PC42	34
---	----------	----

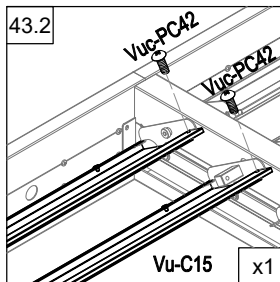
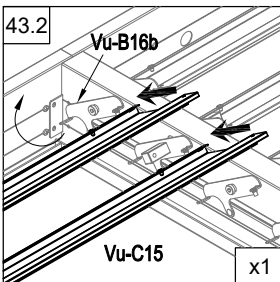
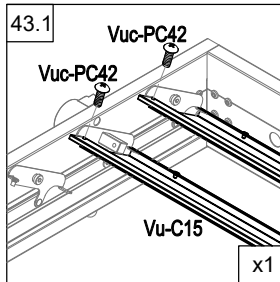
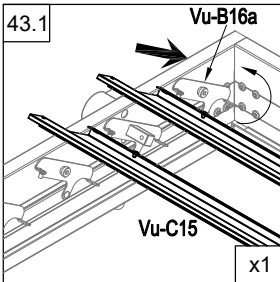
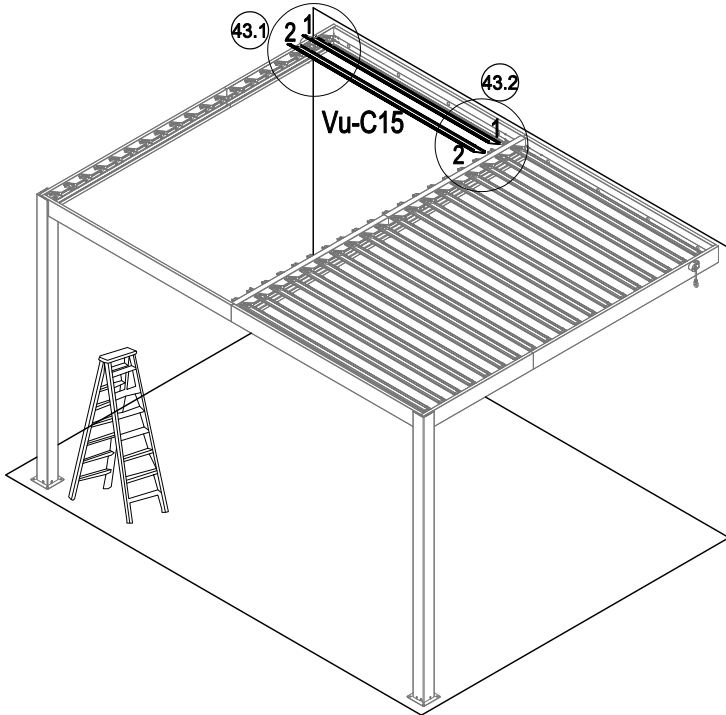

	Vu-C-PC42	4
---	-----------	---

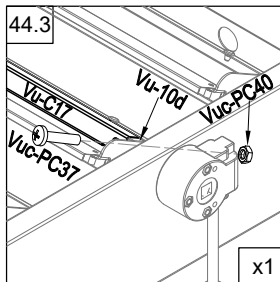
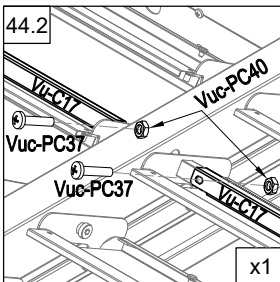
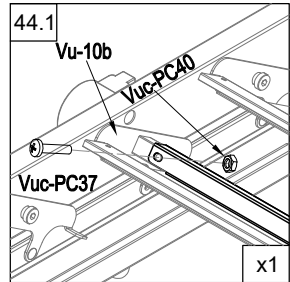
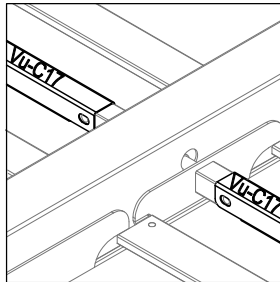
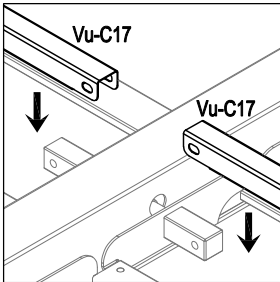
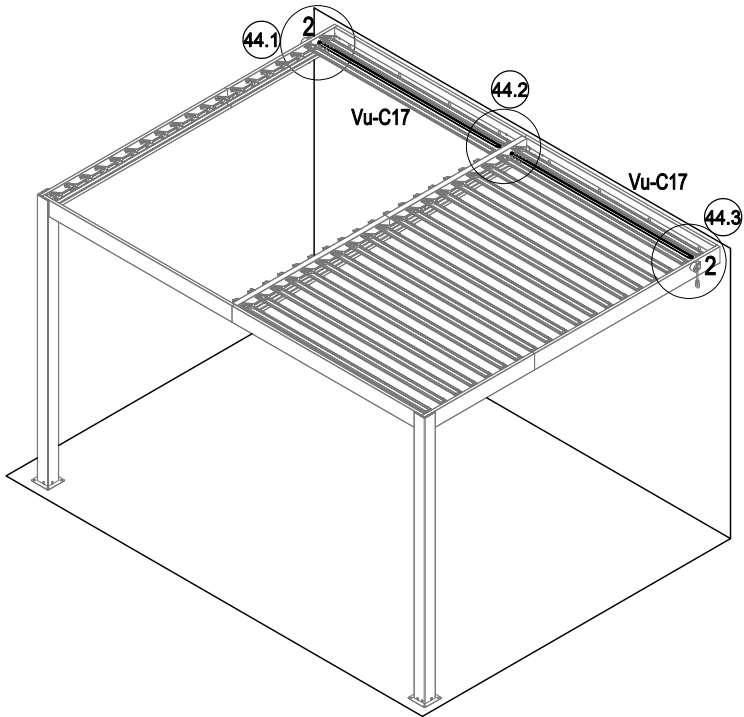

	Vu-C17	2
	Vuc-PC37	4
	Vuc-PC40	4

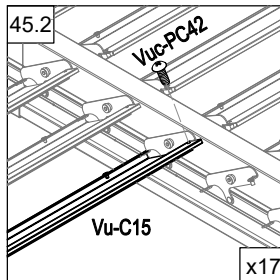
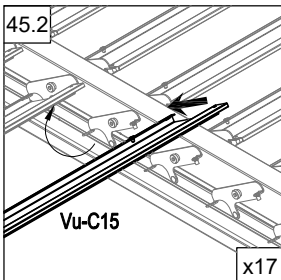
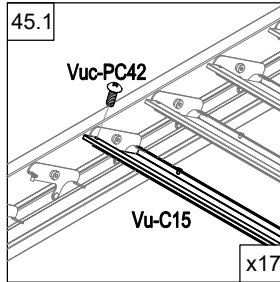
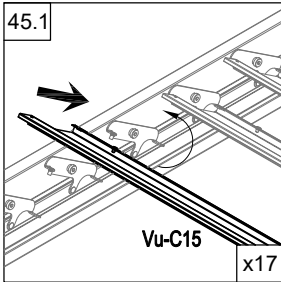
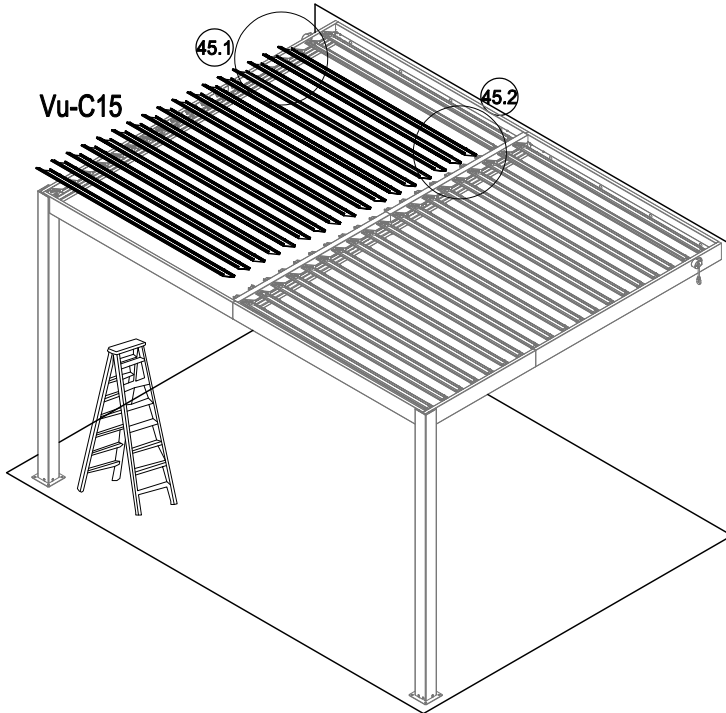



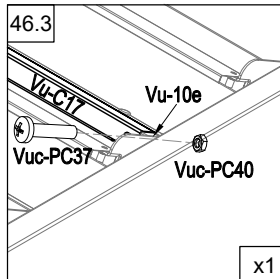
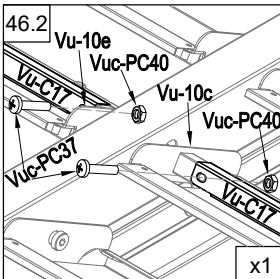
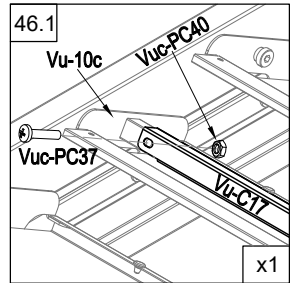
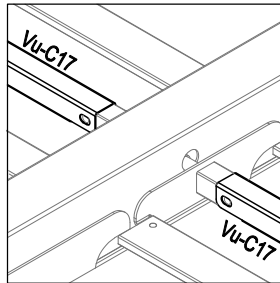
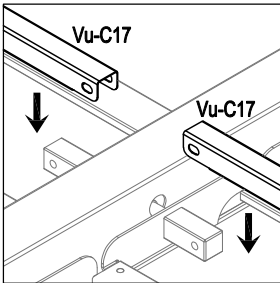
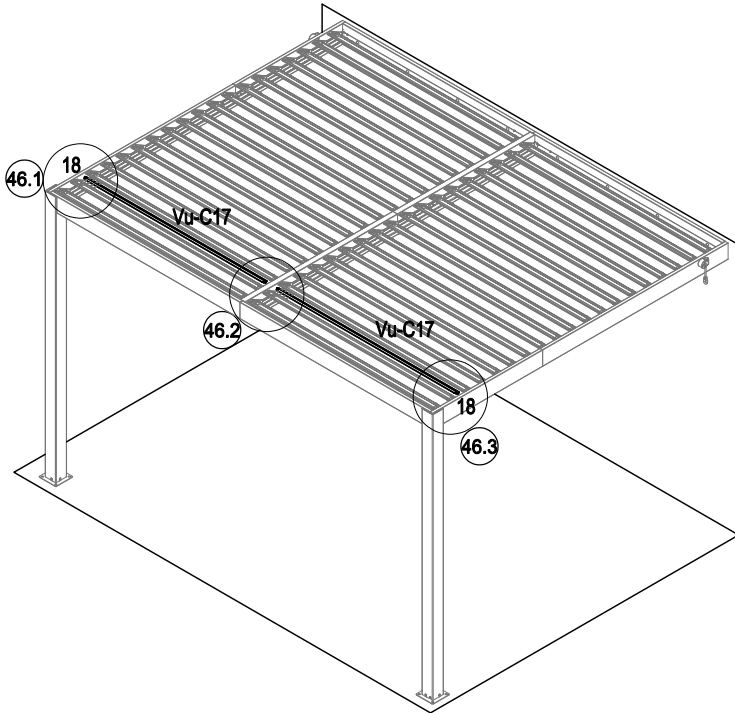

	Vuc-PC42	34
---	----------	----

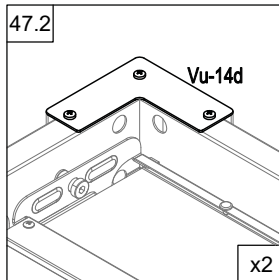
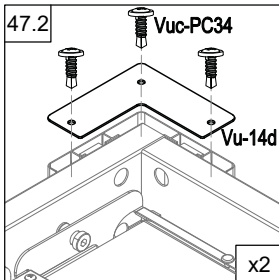
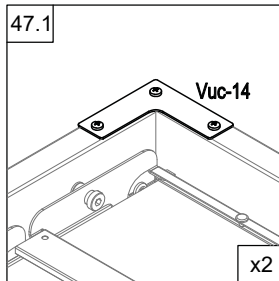
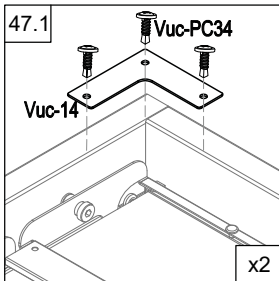
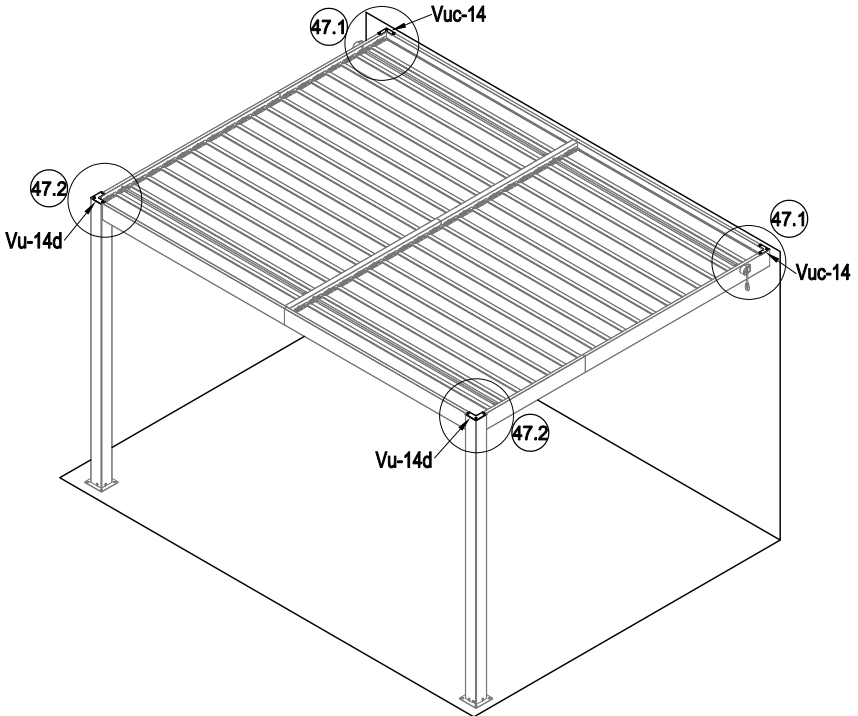

	Vu-C17	2
	Vuc-PC37	4
	Vuc-PC40	4





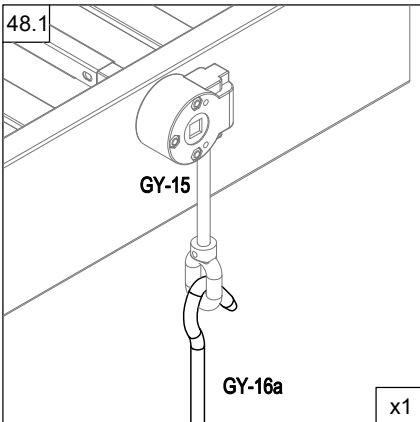
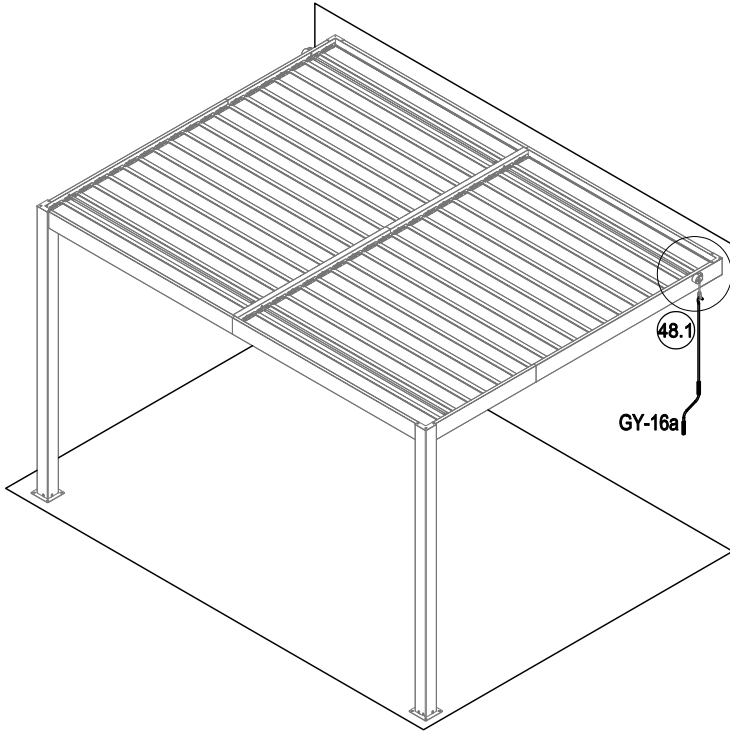

	Vu-14d	2
	Vuc-14	2
	Vuc-PC34	12

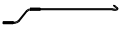

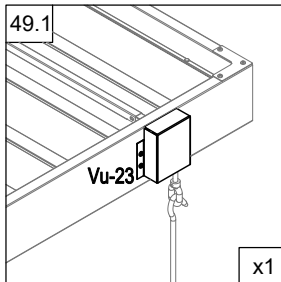
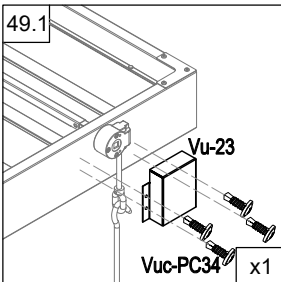
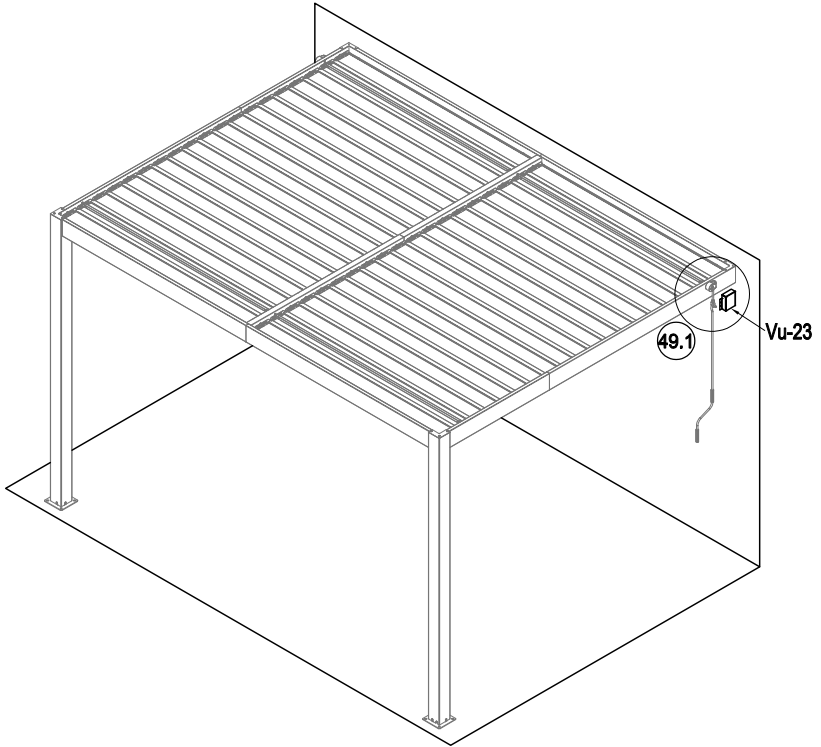

	GY-16a	1
---	--------	---

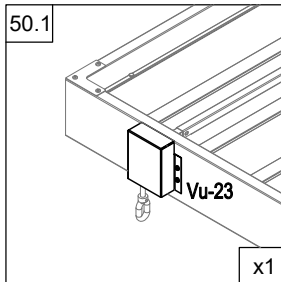
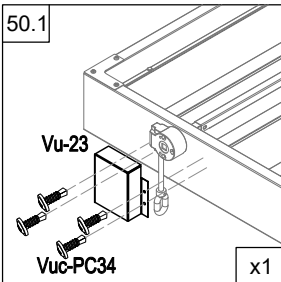
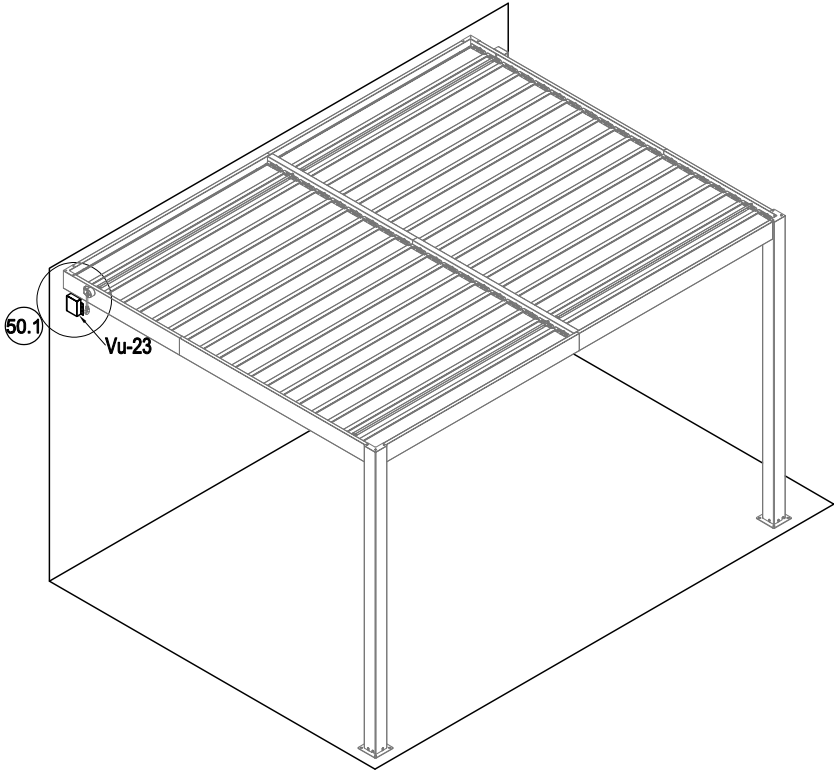

	Vu-23	1
	Vuc-PC34	4



	<b>Vu-23</b>	1
	<b>Vuc-PC34</b>	4

## 1/ Product

### **Properties**

For outdoor use only.

The frame is made of aluminium parts, a material renowned for its lightness, strength and resistance to the harshest weather conditions. Moreover, it doesn't rust.

The blades are made of steel, a material renowned for its durability and strength.

### **Assembly**

The manufacture and assembly of this product requires that there is a gap between the individual parts. As a result, gaps of up to several millimeters are generally observed between the two components.

This tolerance is necessary for the correct realization of the product and can be the cause of geometrical differences.

This will not result in any loss of product functionality.

## 2/ Precautions for use

We cannot guarantee the durability of the product during difficult weather conditions.

It is suggested that you avoid being near or under the structure during rainy and stormy weather.

Once a major weather event has passed, we recommend that you assess the overall condition of the structure before use.

The accumulation of snow, leaves or objects on the roof contributes to its degradation and that of the structure: make sure to clean it regularly.

We advise against heat sources and lighting on or near the structure.

## 3/ Maintenance

It is common for the product to show natural wear with time and use, resulting in deterioration of the colours and surface finishes, mechanical functions and tightening of the elements.

### **UV exposure**

It's normal for materials such as paints to become discoloured by UV light.

Each ray of sunlight or moonlight creates a new variation in the substance.

Colours normally wear out due to exposure to the outside world.

### **Tightening**

Your product needs regular maintenance to remain functional. Doing these repairs yourself on a regular basis can improve the longevity of the product. Remember to tighten the components regularly.

### **Regular maintenance**

It is important to maintain your product properly so that it does not deteriorate.

An aluminium structure has the advantage that you don't have to invest in products or equipment that are too specific.

**All you need is:**

- A soft sponge.
- A microfiber cloth.
- And a water jet.

Use a soft sponge with warm soapy water to remove any dust and dirt that has settled on the pergola. After cleaning, rinse with clean water (you can use a jet if it isn't high-pressure). Don't forget to rinse the feet as well so that no dirt remains. Finally, you can finish your work by wiping the structure with a microfibre cloth to dry it and restore its brilliance.

- Do not use abrasive products or detergents (bleach, acetone, etc.) that could damage the aluminium.
- Do not use a hard bristle brush, which could also damage the structure.
- Do not use a high-pressure jet.

Repeat the process for the steel blades.

## Conseils d'entretien

**FR**

### 1/ Produit

**Propriétés**

Pour usage extérieur uniquement.

L'armature est composée de pièces en aluminium, matériau reconnu pour sa légèreté, sa robustesse et résistant aux intempéries les plus fortes. De plus, il ne rouille pas.

Les lames sont en acier, matériau reconnu pour sa durabilité et sa résistance.

**Assemblage**

La fabrication puis l'assemblage de ce produit nécessite de laisser un jeu d'ajustement entre les différentes pièces.

Par conséquent, des écarts allant jusqu'à plusieurs millimètres sont généralement observés entre les deux composants.

Cette tolérance est nécessaire à la bonne réalisation du produit et peut être à l'origine de différence géométrique.

Cela n'entraînera aucune perte de fonctionnalité du produit.

### 2/ Précautions d'utilisation

Nous ne pouvons garantir la durabilité du produit lors de conditions météorologiques difficiles.

Il est suggéré d'éviter d'être à proximité ou sous la structure en cas de temps pluvieux et tempétueux.

Une fois qu'un événement météorologique majeur est passé, nous vous recommandons d'évaluer l'état général de la structure avant usage.

L'accumulation de neige, de feuilles mortes ou d'objets sur le toit contribue à sa dégradation et à celle de la structure : veillez à le nettoyer régulièrement.

Nous déconseillons les sources de chaleur et lumineuse sur ou à proximité de la structure.

## **3/ Entretien**

Il est courant que le produit présente une usure naturelle avec le temps et l'utilisation qui se traduit par une détérioration des couleurs et des états de surface, des fonctions mécaniques et du serrage des éléments.

### **Exposition aux UV**

Il est normal que les matériaux se trouvent décolorés par la lumière UV comme les peintures. Chaque rayon de la lumière du soleil ou de la lune crée une nouvelle variation de la matière. Les couleurs s'usent normalement en raison de l'exposition au monde extérieur.

### **Serrages**

Votre produit a besoin d'un entretien régulier pour rester fonctionnel. En effectuant vous-même ces réparations de façon régulière, vous pouvez améliorer la longévité du produit. Pensez à bien resserrer les éléments assidûment.

### **Entretien régulier**

Il est important de bien entretenir son produit afin qu'il ne se détériore pas.

Une structure en aluminium a l'avantage de ne pas demander d'investir dans des produits ou dans du matériel trop spécifique.

### **Vous avez ainsi tout simplement besoin :**

- D'une éponge douce ;
- D'un chiffon en microfibres ;
- Et d'un jet d'eau.

Utilisez une éponge douce avec de l'eau tiède savonneuse afin de faire partir les poussières et les saletés qui se sont déposées sur la pergola.

Une fois ce nettoyage effectué, rincez à l'eau claire (vous pouvez utiliser un jet, s'il n'est pas à haute pression). N'oubliez pas de bien rincer également les pieds pour qu'il ne reste aucune saleté.

Enfin, vous pouvez finaliser votre travail en passant un chiffon en microfibres sur la structure pour la sécher et lui redonner tout son éclat.

- N'utilisez pas de produit abrasif ou de détergent (javel, acétone...) qui pourraient endommager l'aluminium.
- N'utilisez pas de brosse à poils durs, qui pourrait également abîmer la structure.
- N'utilisez pas de jet à haute pression.

Répétez le processus pour les lames en acier.

## Consejos de mantenimiento

ES

### 1/ Producto

#### **Propiedades**

Sólo para uso en exteriores.

El bastidor está fabricado con piezas de aluminio, un material conocido por su ligereza, solidez y resistencia a las condiciones climáticas más duras. Además, no se oxida.

Las lamas son de acero, un material conocido por su durabilidad y resistencia.

#### **Montaje**

La fabricación y el montaje de este producto requieren que haya un espacio entre las diferentes partes. En consecuencia, se observan generalmente huecos de hasta varios milímetros entre los dos componentes.

Esta tolerancia es necesaria para la correcta realización del producto y puede ser la causa de las diferencias geométricas.

Esto no supondrá ninguna pérdida de funcionalidad del producto.

### 2/ Precauciones de uso

No podemos garantizar la durabilidad del producto en condiciones climáticas difíciles.

Se sugiere evitar estar cerca o debajo de la estructura en tiempo de lluvia y tormenta.

Una vez que haya pasado un evento meteorológico importante, se recomienda evaluar el estado general de la estructura antes de utilizarla.

La acumulación de nieve, hojas u objetos en el tejado contribuye a su degradación y a la de la estructura: asegúrese de limpiarlo regularmente.

Aconsejamos que no haya fuentes de calor ni luces en la estructura o cerca de ella.

### 3/ Mantenimiento

Es habitual que el producto presente un desgaste natural con el paso del tiempo y el uso, lo que se traduce en un deterioro de los colores y los acabados superficiales, de las funciones mecánicas y de la estanqueidad de los elementos.

#### **Exposición a los rayos UV**

Es normal que los materiales se decoloren con la luz UV, como las pinturas.

Cada rayo de sol o de luna crea una nueva variación en el material.

Los colores normalmente se desgastan debido a la exposición al mundo exterior.

#### **Apretando**

Su producto necesita un mantenimiento regular para seguir funcionando. Si realiza usted mismo estas reparaciones con regularidad, puede mejorar la longevidad del producto. Recuerde que debe apretar los componentes con regularidad.

#### **Mantenimiento regular**

Es importante mantener el producto adecuadamente para que no se deteriore.

Una estructura de aluminio tiene la ventaja de no tener que invertir en productos o materiales demasiado específicos.



## **Todo lo que necesitas es :**

- Una esponja suave;
- Un paño de microfibra;
- Y un chorro de agua.

Utilice una esponja suave con agua tibia y jabón para eliminar el polvo y la suciedad que se haya depositado en la pérgola.

Tras la limpieza, aclare con agua limpia (puede utilizar un chorro si no es de alta presión). No olvides aclarar también los pies para que no quede suciedad.

Por último, puedes terminar tu trabajo limpiando la estructura con un paño de microfibra para secarla y devolverle el brillo.

- No utilice productos abrasivos ni detergentes (lejía, acetona, etc.) que puedan dañar el aluminio.
- No utilice un cepillo de cerdas duras, que también podría dañar la estructura.
- No utilice un chorro de alta presión.

Repita el proceso para las cuchillas de acero.

## **Pflegetipps**

**DE**

### **1/ Produkt**

#### **Eigenschaften**

Nur für den Außenbereich geeignet.

Das Gestell besteht aus Aluminiumteilen, einem Material, das für seine Leichtigkeit, Stärke und Widerstandsfähigkeit gegen die härtesten Wetterbedingungen bekannt ist. Außerdem rostet es nicht.

Die Lamellen sind aus Stahl, einem Material, das für seine Haltbarkeit und Stärke bekannt ist.

#### **Zusammenbau**

Die Herstellung und Montage dieses Produkts erfordert, dass zwischen den einzelnen Teilen ein Spalt besteht.

Daher sind in der Regel Lücken von bis zu mehreren Millimetern zwischen den beiden Komponenten zu beobachten.

Diese Toleranz ist für die korrekte Ausführung des Produkts erforderlich und kann die Ursache für geometrische Unterschiede sein.

Dies führt jedoch nicht zu einer Beeinträchtigung der Produktfunktionalität.

### **2/ Vorsichtsmaßnahmen für den Gebrauch**

Wir können keine Garantie für die Haltbarkeit des Produkts bei schwierigen Wetterbedingungen übernehmen.

Es wird empfohlen, sich bei Regen und Sturm nicht in der Nähe oder unter der Konstruktion aufzuhalten.

Wenn ein größeres Wetterereignis vorüber ist, empfehlen wir Ihnen, den Gesamtzustand der Konstruktion vor der Benutzung zu überprüfen.

Die Ansammlung von Schnee, Laub oder Gegenständen auf dem Dach trägt zu seiner Verschlechterung und der der Konstruktion bei: achten Sie darauf, es regelmäßig zu reinigen.

Wir raten von Wärmequellen und Beleuchtung auf oder in der Nähe der Konstruktion ab.

### **3/ Wartung**

Es ist normal, dass das Produkt mit der Zeit und dem Gebrauch natürliche Abnutzungserscheinungen zeigt, die zu einer Verschlechterung der Farben und der Oberflächenbeschaffenheit, der mechanischen Funktionen und der Festigkeit der Elemente führen.

#### **UV-Belastung**

Es ist normal, dass Materialien wie Lacke durch UV-Licht verfärbt werden.

Jeder Sonnen- oder Mondstrahl erzeugt eine neue Veränderung in der Substanz.

Farben nutzen sich normalerweise durch die Einwirkung der Außenwelt ab.

#### **Anziehen**

Ihr Produkt muss regelmäßig gewartet werden, um funktionsfähig zu bleiben. Wenn Sie diese Reparaturen regelmäßig selbst durchführen, können Sie die Langlebigkeit des Produkts verbessern. Denken Sie daran, die Komponenten regelmäßig nachzuspannen.

#### **Regelmäßige Wartung**

Es ist wichtig, Ihr Produkt richtig zu warten, damit es nicht kaputt geht.

Eine Aluminiumkonstruktion hat den Vorteil, dass Sie nicht in allzu spezielle Produkte oder Geräte investieren müssen.

#### **Alles was Sie brauchen ist:**

- Einen weichen Schwamm;
- ein Mikrofasertuch;
- Und einen Wasserstrahl.

Verwenden Sie einen weichen Schwamm mit warmer Seifenlauge, um Staub und Schmutz zu entfernen, der sich auf der Pergola abgesetzt hat.

Nach der Reinigung spülen Sie mit sauberem Wasser nach (Sie können einen Wasserstrahl verwenden, wenn es sich nicht um einen Hochdruckreiniger handelt). Vergessen Sie nicht, auch die Füße abzuspülen, damit kein Schmutz zurückbleibt.

Zum Schluss können Sie die Struktur mit einem Mikrofasertuch abwischen, um sie zu trocknen und ihren Glanz wiederherzustellen.

- Verwenden Sie keine Scheuermittel oder Reinigungsmittel (Bleichmittel, Aceton usw.), die das Aluminium beschädigen könnten.
- Verwenden Sie keine Bürste mit harten Borsten, da diese die Struktur ebenfalls beschädigen könnten.
- Verwenden Sie keinen Hochdruckreiniger.

Wiederholen Sie den Vorgang für die Stahlklingen.

### **1/ Prodotto**

#### **Proprietà**

Solo per uso esterno.

Il telaio è realizzato con parti in alluminio, un materiale noto per la sua leggerezza, la sua forza e la sua resistenza alle condizioni atmosferiche più difficili. Inoltre, non arrugginisce.

Le doghe sono in acciaio, un materiale noto per la sua durata e resistenza.

#### **Montaggio**

La fabbricazione e l'assemblaggio di questo prodotto richiedono la presenza di uno spazio tra le diverse parti.

Di conseguenza, tra i due componenti si osservano generalmente spazi vuoti fino a diversi millimetri. Questa tolleranza è necessaria per la corretta realizzazione del prodotto e può essere la causa di differenze geometriche.

Ciò non comporterà alcuna perdita di funzionalità del prodotto.

### **2/ Precauzioni per l'uso**

Non possiamo garantire la durata del prodotto in condizioni climatiche difficili.

Si consiglia di evitare di stare vicino o sotto la struttura in caso di pioggia e temporali.

Una volta passato un evento meteorologico importante, si consiglia di valutare le condizioni generali della struttura prima di utilizzarla.

L'accumulo di neve, foglie o oggetti sul tetto contribuisce al suo degrado e a quello della struttura: assicuratevi di pulirli regolarmente.

Si consiglia di non utilizzare fonti di calore e di illuminazione sopra o vicino alla struttura.

### **3/ Manutenzione**

È comune che il prodotto mostri una naturale usura nel tempo e con l'uso, con conseguente deterioramento dei colori e delle finiture superficiali, delle funzioni meccaniche e dell'irrigidimento degli elementi.

#### **Esposizione ai raggi UV**

È normale che i materiali si scoloriscano a causa dei raggi UV, come le vernici.

Ogni raggio di sole o di luna crea una nuova variazione nel materiale.

I colori normalmente si consumano a causa dell'esposizione al mondo esterno.

#### **Serraggio**

Il vostro prodotto ha bisogno di una manutenzione regolare per rimanere funzionante. Eseguendo regolarmente queste riparazioni da soli, è possibile migliorare la longevità del prodotto. Ricordate di serrare regolarmente i componenti.

#### **Manutenzione regolare**

È importante effettuare una corretta manutenzione del prodotto per evitare che si deteriori.

Una struttura in alluminio ha il vantaggio di non dover investire in prodotti o materiali troppo specifici.

**Tutto ciò che serve è :**

- Una spugna morbida;
- Un panno in microfibra;
- E un getto d'acqua.

Utilizzare una spugna morbida con acqua tiepida e sapone per rimuovere la polvere e lo sporco che si sono depositati sulla pergola.

Dopo la pulizia, risciacquare con acqua pulita (si può usare un getto se non è ad alta pressione). Non dimenticate di sciacquare anche i piedi, in modo che non rimangano tracce di sporco.

Infine, si può terminare il lavoro passando un panno in microfibra per asciugare la struttura e ripristinarne la lucentezza.

- Non utilizzare prodotti abrasivi o detergenti (candeggina, acetone, ecc.) che potrebbero danneggiare l'alluminio.
- Non utilizzare una spazzola a setole dure, che potrebbe danneggiare la struttura.
- Non utilizzare un getto ad alta pressione.

Ripetere il procedimento per le lame in acciaio.

## Dicas de manutenção

**PT**

### 1/ Produto

#### **Imóveis**

Apenas para uso exterior.

A estrutura é feita de peças de alumínio, um material conhecido pela sua leveza, força e resistência às mais duras condições climáticas. Além disso, não enferruja.

As ripas são feitas de aço, um material conhecido pela sua durabilidade e resistência.

#### **Assembleia**

O fabrico e montagem deste produto exige que haja um intervalo entre as diferentes partes.

Consequentemente, são geralmente observadas lacunas de até vários milímetros entre os dois componentes.

Esta tolerância é necessária para a correcta realização do produto e pode ser a causa de diferenças geométricas.

Isto não resultará em qualquer perda de funcionalidade do produto.

### 2/ Precauções de utilização

Não podemos garantir a durabilidade do produto em condições climáticas difíceis.

Sugere-se evitar estar perto ou debaixo da estrutura durante o tempo chuvoso e tempestuoso.

Uma vez passado um evento meteorológico importante, recomendamos que avalie o estado geral da estrutura antes da sua utilização.

A acumulação de neve, folhas ou objectos no telhado contribui para a sua degradação e para a da estrutura: certifique-se de que a limpa regularmente.

Aconselhamos contra fontes de calor e iluminação na estrutura ou perto dela.

## **3/ Manutenção**

É comum que o produto apresente desgaste natural ao longo do tempo e com o uso, resultando na deterioração das cores e acabamentos superficiais, funções mecânicas e aperto dos elementos.

### **Exposição UV**

É normal que os materiais fiquem descoloridos pela luz UV, tais como as tintas.

Cada raio de luz solar ou lunar cria uma nova variação no material.

As cores normalmente desgastam-se devido à exposição ao mundo exterior.

### **Aperto**

O seu produto necessita de manutenção regular para se manter funcional. Ao fazer estas reparações regularmente, pode melhorar a longevidade do produto. Lembre-se de apertar os componentes regularmente.

### **Manutenção regular**

É importante manter o seu produto correctamente para que ele não se deteriore.

Uma estrutura de alumínio tem a vantagem de não ter de investir em produtos ou materiais demasiado específicos.

### **Tudo o que precisa é :**

- Uma esponja macia ;
- Um pano em microfibra;
- E um jacto de água.

Utilizar uma esponja macia com água morna e sabão para remover qualquer poeira e sujidade que se tenha assentado na pérgula.

Após a limpeza, enxaguar com água limpa (pode usar um jacto se não for de alta pressão). Não se esqueça de enxaguar também os pés para que não reste sujidade.

Finalmente, pode terminar o seu trabalho limpando a estrutura com um pano de microfibras para a secar e restaurar o seu brilho.

- Não utilizar produtos abrasivos ou detergentes (lixívia, acetona, etc.) que possam danificar o alumínio.
- Não utilizar uma escova de cerdas duras, o que também poderia danificar a estrutura.
- Não utilizar um jacto de alta pressão.

Repetir o processo para as lâminas de aço.

## Tips voor onderhoud

NL

### 1/ Product

#### **Eigenschappen**

Alleen voor gebruik buitenshuis.

Het frame bestaat uit aluminium onderdelen, een materiaal dat bekend staat om zijn lichtheid, sterkte en weerstand tegen de zwaarste weersomstandigheden. Bovendien roest het niet.

De bladen zijn van staal, een materiaal dat bekend staat om zijn duurzaamheid en sterkte.

#### **Montage**

De vervaardiging en montage van dit product vereist dat er een opening is tussen de afzonderlijke onderdelen.

Bijgevolg worden tussen de twee onderdelen doorgaans openingen van enkele millimeters vastgesteld. Deze tolerantie is noodzakelijk voor de correcte realisatie van het product en kan de oorzaak zijn van geometrische verschillen.

Dit leidt niet tot verlies van de functionaliteit van het product.

### 2/ Voorzorgsmaatregelen voor gebruik

Wij kunnen de duurzaamheid van het product in moeilijke weersomstandigheden niet garanderen.

Wij raden u aan om tijdens regenachtig en stormachtig weer niet in de buurt of onder de constructie te zijn.

Zodra een grote weersomstandigheid voorbij is, raden wij u aan de algemene toestand van de structuur te beoordelen vóór gebruik.

De ophoping van sneeuw, bladeren of voorwerpen op het dak draagt bij tot de achteruitgang ervan en van de structuur: zorg ervoor dat het regelmatig wordt schoongemaakt.

Warmtebronnen en verlichting op of in de buurt van de structuur worden afgeraden.

### 3/ Onderhoud

Het is gebruikelijk dat het product met de tijd en het gebruik natuurlijke slijtage vertoont, waardoor de kleuren en de afwerking van het oppervlak, de mechanische functies en het vastzitten van de elementen achteruitgaan.

#### **UV-blootstelling**

Het is normaal dat materialen zoals verf verkleuren door UV-licht.

Elke zonnestraal of maanlicht creëert een nieuwe variatie in de stof.

Kleuren slijten gewoonlijk door blootstelling aan de buitenwereld.

#### **Aanscherping**

Uw product heeft regelmatig onderhoud nodig om functioneel te blijven. Door deze reparaties regelmatig zelf uit te voeren, kunt u de levensduur van het product verlengen. Vergeet niet de onderdelen regelmatig aan te draaien.

## Regelmatig onderhoud

Het is belangrijk om uw product goed te onderhouden zodat het niet verslechtert.

Een aluminium constructie heeft het voordeel dat u niet hoeft te investeren in al te specifieke producten of apparatuur.

### Alles wat u nodig heeft is :

- Een zachte spons;
- Een microvezeldoek;
- En een waterstraal.

Gebruik een zachte spons met warm zeepwater om al het stof en vuil dat zich op de pergola heeft afgezet te verwijderen.

Spoel na het schoonmaken met schoon water (u kunt een waterstraal gebruiken als het geen hoge druk is). Vergeet niet ook de voeten af te spoelen zodat er geen vuil achterblijft.

Ten slotte kunt u uw werk afmaken door de structuur af te nemen met een microvezeldoek om hem te drogen en zijn glans te herstellen.

- Gebruik geen schurende producten of detergenten (bleekmiddel, aceton, enz.) die het aluminium kunnen beschadigen.
- Gebruik geen harde borstel, die de structuur eveneens zou kunnen beschadigen.
- Gebruik geen hogedrukspuit.

Herhaal de procedure voor de stalen bladen.

## Wskazówki dotyczące konserwacji

PL

### 1/ Produkt

#### Właściwości

Tylko do użytku zewnętrznego.

Rama wykonana jest z elementów aluminiowych, materiału słynącego z lekkości, wytrzymałości i odporności na najtrudniejsze warunki atmosferyczne. Ponadto, nie rdzewieje.

Łopatki wykonane są ze stali, materiału znanego ze swojej trwałości i wytrzymałości.

#### Montaż

Wykonanie i montaż tego produktu wymaga zachowania szczeliny pomiędzy poszczególnymi częściami. W związku z tym, pomiędzy dwoma komponentami obserwuje się zazwyczaj szczeliny o wielkości do kilku milimetrów.

Tolerancja ta jest niezbędna do prawidłowego wykonania produktu i może być przyczyną różnic geometrycznych.

Nie spowoduje to utraty funkcjonalności produktu.

### 2/ Środki ostrożności dotyczące użytkowania

Nie możemy zagwarantować trwałości produktu podczas trudnych warunków atmosferycznych.

Sugeruje się, aby unikać przebywania w pobliżu lub pod konstrukcją podczas deszczowej i burzowej pogody.

**Regelmatig onderhoud**

Het is belangrijk om uw product goed te onderhouden zodat het niet verslechtert.

Een aluminium constructie heeft het voordeel dat u niet hoeft te investeren in al te specifieke producten of apparatuur.

**Alles wat u nodig heeft is :**

- Een zachte spons;
- Een microvezeldoek;
- En een waterstraal.

Gebruik een zachte spons met warm zeepwater om al het stof en vuil dat zich op de pergola heeft afgezet te verwijderen.

Spoel na het schoonmaken met schoon water (u kunt een waterstraal gebruiken als het geen hoge druk is). Vergeet niet ook de voeten af te spoelen zodat er geen vuil achterblijft.

Ten slotte kunt u uw werk afmaken door de structuur af te nemen met een microvezeldoek om hem te drogen en zijn glans te herstellen.

- Gebruik geen schurende producten of detergenten (bleekmiddel, aceton, enz.) die het aluminium kunnen beschadigen.
- Gebruik geen harde borstel, die de structuur eveneens zou kunnen beschadigen.
- Gebruik geen hogedrukspuit.

Herhaal de procedure voor de stalen bladen.

**Wskazówki dotyczące konserwacji****PL****1/ Produkt****Właściwości**

Tylko do użytku zewnętrznego.

Rama wykonana jest z elementów aluminiowych, materiału słynącego z lekkości, wytrzymałości i odporności na najtrudniejsze warunki atmosferyczne. Ponadto, nie rdzewieje.

Łopatki wykonane są ze stali, materiału znanego ze swojej trwałości i wytrzymałości.

**Montaż**

Wykonanie i montaż tego produktu wymaga zachowania szczeliny pomiędzy poszczególnymi częściami. W związku z tym, pomiędzy dwoma komponentami obserwuje się zazwyczaj szczeliny o wielkości od kilku milimetrów.

Tolerancja ta jest niezbędna do prawidłowego wykonania produktu i może być przyczyną różnic geometrycznych.

Nie spowoduje to utraty funkcjonalności produktu.

**2/ Środki ostrożności dotyczące użytkowania**

Nie możemy zagwarantować trwałości produktu podczas trudnych warunków atmosferycznych.

Sugeruje się, aby unikać przebywania w pobliżu lub pod konstrukcją podczas deszczowej i burzowej pogody.



Po przejściu poważnego zdarzenia pogodowego zalecamy, aby przed użyciem ocenić ogólny stan konstrukcji.

Gromadzenie się śniegu, liści lub przedmiotów na dachu przyczynia się do jego degradacji oraz degradacji konstrukcji: należy pamiętać o regularnym czyszczeniu.

Odradzamy źródła ciepła i oświetlenie na lub w pobliżu konstrukcji.

### **3/ Konserwacja**

Powszechne jest, że produkt wykazuje naturalne zużycie wraz z czasem i użytkowaniem, co powoduje pogorszenie kolorów i wykończenia powierzchni, funkcji mechanicznych i dokręcanie elementów.

#### **Narażenie na działanie promieniowania UV**

To normalne, że materiały takie jak farby odbarwiają się pod wpływem promieniowania UV.

Każdy promień światła słonecznego lub księżycowego tworzy nową zmianę w substancji.

Kolory zwykle zużywają się w wyniku wystawienia na działanie czynników zewnętrznych.

#### **Dokręcanie**

Twój produkt wymaga regularnej konserwacji, aby zachować funkcjonalność. Wykonywanie tych napraw samodzielnie w regularnych odstępach czasu może zwiększyć trwałość produktu. Pamiętaj, aby regularnie dokręcać elementy.

#### **Regularna konserwacja**

Ważne jest, aby odpowiednio konserwować swój produkt, aby nie uległ on zniszczeniu.

Konstrukcja aluminiowa ma tę zaletę, że nie musisz inwestować w zbyt specyficzne produkty lub sprzęt.

#### **Wszystko czego potrzebujesz to:**

- Miękka gąbka;
- Ściereczka z mikrofibry;
- I strumień wody.

Użyj miękkiej gąbki z ciepłą wodą z mydłem, aby usunąć kurz i brud, który osiadł na pergoli.

Po czyszczeniu, spłukać czystą wodą (można użyć strumienia, jeśli nie jest pod wysokim ciśnieniem). Nie zapomnij spłukać również stóp, aby nie pozostały żadne zabrudzenia.

Na koniec możesz zakończyć pracę, przecierając strukturę ściereczką z mikrofibry, aby ją osuszyć i przywrócić jej blask.

- Nie używaj produktów ściernych ani detergentów (wybielaczy, acetonu itp.), które mogłyby uszkodzić aluminium.
- Nie używaj szczotki z twardym włosiem, która również mogłaby uszkodzić strukturę.
- Nie używać strumienia wysokociśnieniowego.

Powtórzyć proces dla ostrzy stalowych.cv

## Tips til vedligeholdelse

DK

### 1/ Produkt

#### **Egenskaber**

Kun til udendørs brug.

Rammen er fremstillet af aluminiumsdele, et materiale, der er kendt for sin lethed, styrke og modstandsdygtighed over for de hårdeste vejrforhold. Desuden ruster det ikke.

Bladene er fremstillet af stål, et materiale, der er kendt for sin holdbarhed og styrke.

#### **Montering**

Fremstillingen og monteringen af dette produkt kræver, at der er et mellemrum mellem de enkelte dele. Som følge heraf observeres der generelt mellemrum på op til flere millimeter mellem de to komponenter.

Denne tolerance er nødvendig for en korrekt udførelse af produktet og kan være årsag til geometriske forskelle.

Dette medfører dog ikke tab af produktfunktionalitet.

### 2/ Forholdsregler ved brug

Vi kan ikke garantere produktets holdbarhed under vanskelige vejrforhold.

Det foreslås, at du undgår at opholde dig i nærheden af eller under konstruktionen i regn- og stormvejr.

Når en større vejrbegebenhed er overstået, anbefaler vi, at du vurderer strukturens generelle tilstand, inden den tages i brug.

Ophobning af sne, blade eller genstande på taget bidrager til nedbrydningen af det og af konstruktionen: sørg for at rengøre det regelmæssigt.

Vi fraråder varmekilder og belysning på eller i nærheden af strukturen.

### 3/ Vedligeholdelse

Det er almindeligt, at produktet viser naturlig slitage med tiden og brugen, hvilket resulterer i forringelse af farver og overfladebehandlinger, mekaniske funktioner og stramning af elementerne.

#### **UV-eksponering**

Det er normalt, at materialer som f.eks. maling bliver misfarvet af UV-lys.

Hver stråle af sollys eller månelys skaber en ny variation i stoffet.

Farver slides normalt på grund af eksponering for omverdenen.

#### **Stramning**

Dit produkt har brug for regelmæssig vedligeholdelse for at forblive funktionelt. Hvis du selv foretager disse reparationer regelmæssigt, kan du forbedre produktets levetid. Husk at spænde komponenterne regelmæssigt.

#### **Regelmæssig vedligeholdelse**

Det er vigtigt at vedligeholde dit produkt korrekt, så det ikke forringes.

En aluminiumskonstruktion har den fordel, at du ikke behøver at investere i produkter eller udstyr, der er for specifikke.

## Det eneste, du har brug for, er:

- En blød svamp.
- En mikrofiberklud.
- og en vandstråle.

Brug en blød svamp med varmt sæbevand til at fjerne støv og snavs, der har sat sig på pergolaen. Efter rengøringen skylles den med rent vand (du kan bruge en vandstråle, hvis det ikke er højtryksvand). Glem ikke at skylle fødderne også, så der ikke bliver noget snavs tilbage. Endelig kan du afslutte dit arbejde ved at tørre strukturen af med en mikrofiberklud for at tørre den og give den dens glans tilbage.

- Brug ikke slibende produkter eller rengøringsmidler (blegemiddel, acetone osv.), som kan beskadige aluminiumet.
- Brug ikke en børste med hårde børster, som også kan beskadige strukturen.
- Brug ikke en højtryksstråle.

Gentag processen for stålbladene.

## Huoltovihjeitä

FI

### 1/ Tuote

#### Ominaisuudet

Vain ulkokäyttöön.

Runko on valmistettu alumiiniosista, materiaalista, joka on tunnettu keveydestään, lujuudestaan ja kestävydestään ankarimmissakin sääolosuhteissa. Lisäksi se ei ruostu.

Terät on valmistettu teräksestä, materiaalista, joka on tunnettu kestävydestään ja lujuudestaan.

#### Asennus

Tämän tuotteen valmistus ja kokoonpano edellyttävät, että yksittäisten osien välillä on rako.

Tämän vuoksi kahden osan välillä on yleensä jopa useiden millimetrien rakoja.

Tämä toleranssi on välttämätön tuotteen oikean toteutuksen kannalta, ja se voi aiheuttaa geometrisia eroja.

Tämä ei johda tuotteen toiminnallisuuden heikkenemiseen.

### 2/ Käyttöä koskevat varotoimet

Emme voi taata tuotteen kestävyttä vaikeissa sääolosuhteissa.

On suositeltavaa välttää oleskelua rakenteen lähellä tai alla sateisen ja myrskyisen sään aikana.

Kun merkittävä sääilmiö on ohi, suosittelemme, että arvioit rakenteen yleisen kunnon ennen käyttöä. Lumen, lehtien tai esineiden kerääntyminen katolle edistää sen ja rakenteen heikkenemistä: varmista, että se puhdistetaan säännöllisesti.

Suosittelemme, että rakenteen päällä tai sen lähellä ei ole lämmönlähteitä eikä valaistusta.

### **3/ Kunnossapito**

On tavallista, että tuotteessa ilmenee ajan ja käytön myötä luonnollista kulumista, jonka seurauksena värit ja pintakäsittelyt, mekaaniset toiminnot ja elementtien kiristyminen heikkenevät.

#### **UV-altistuminen**

On normaalia, että materiaalit, kuten maalit, värjäytyvät UV-valon vaikutuksesta.

Jokainen auringon- tai kuunvalon säde luo aineeseen uutta vaihtelua.

Värit kuluvat normaalisti ulkoilmalle altistumisen vuoksi.

#### **Kiristäminen**

Tuotteesi tarvitsee säännöllistä huoltoa pysyäkseen toimivana. Tekemällä nämä korjaukset itse säännöllisesti voit parantaa tuotteen pitkäikäisyyttä. Muista kiristää osat säännöllisesti.

#### **Säännöllinen huolto**

On tärkeää huoltaa tuote asianmukaisesti, jotta se ei heikkene.

Alumiinirakenteen etuna on, että sinun ei tarvitse investoida liian erityisiin tuotteisiin tai laitteisiin.

#### **Tarvitset vain:**

- Pehmeä sieni;
- Mikrokuituliina;
- Ja vesisuihku.

Poista pergolaan laskeutunut pöly ja lika pehmeällä sienellä ja lämpimällä saippuavedellä.

Huuhtelee puhdistuksen jälkeen puhtaalla vedellä (voit käyttää suihkua, jos se ei ole korkeapainainen).

Älä unohda huuhdella myös jalkoja, jotta likaa ei jää.

Lopuksi voit viimeistellä työsi pyyhkimällä rakenteen mikrokuituliinalla, jotta se kuivuu ja saa takaisin kirkkautensa.

- Älä käytä hankaavia tuotteita tai pesuaineita (valkaisuaine, asetoni jne.), jotka voivat vahingoittaa alumiinia.
- Älä käytä kovaharjaista harjaa, joka voi myös vahingoittaa rakennetta.
- Älä käytä korkeapainesuihkuja.

Toista prosessi teräksen terille.