

CASANOVO

NALI VELETA 300C160

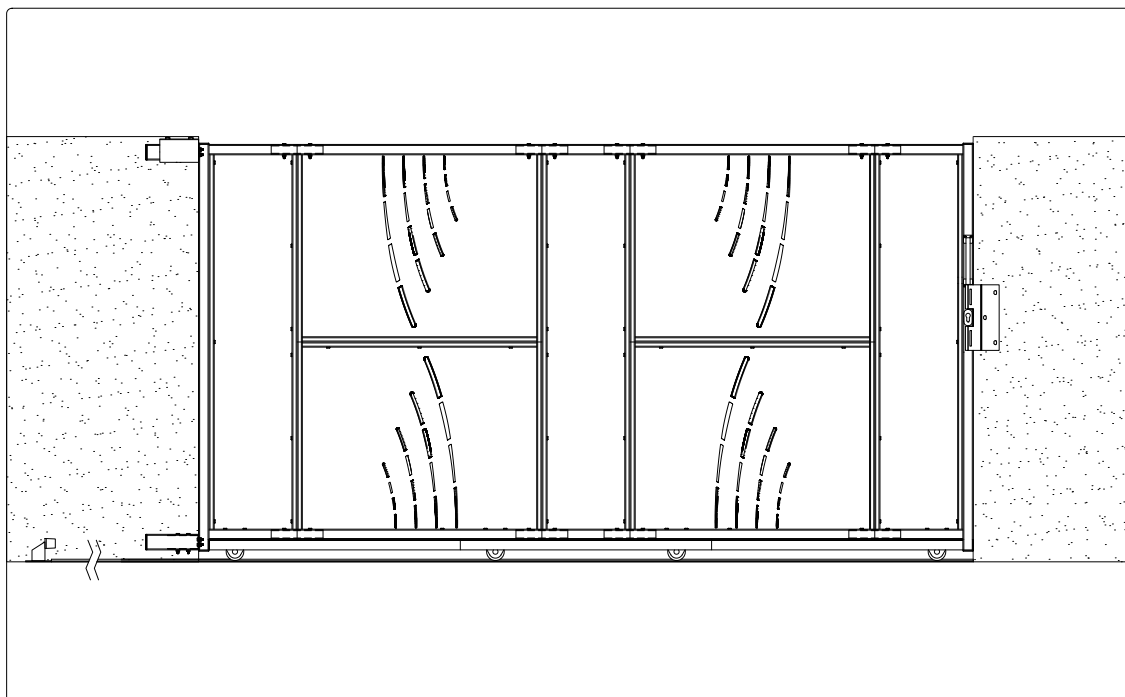

EN FR DE ES PT IT NL PL FI SE DK
RO SI SK HU CZ HR GR LT LV





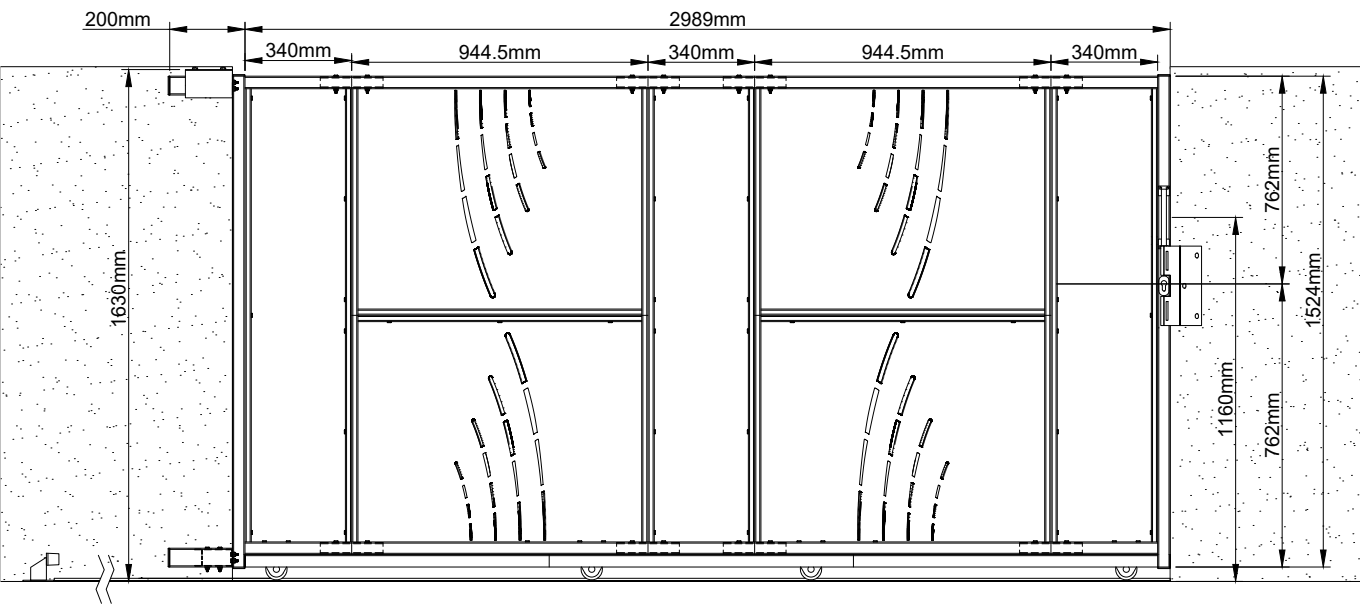



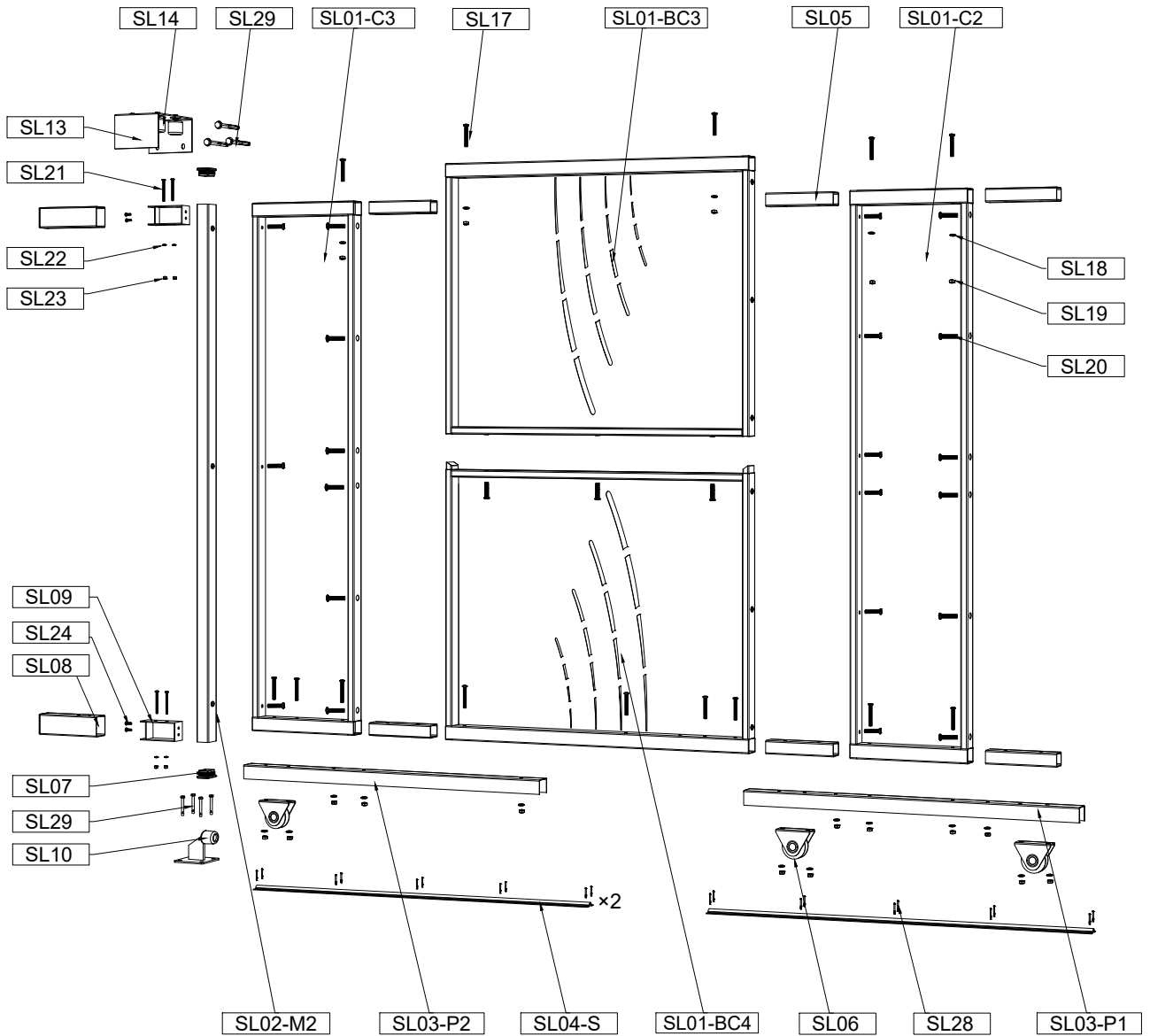

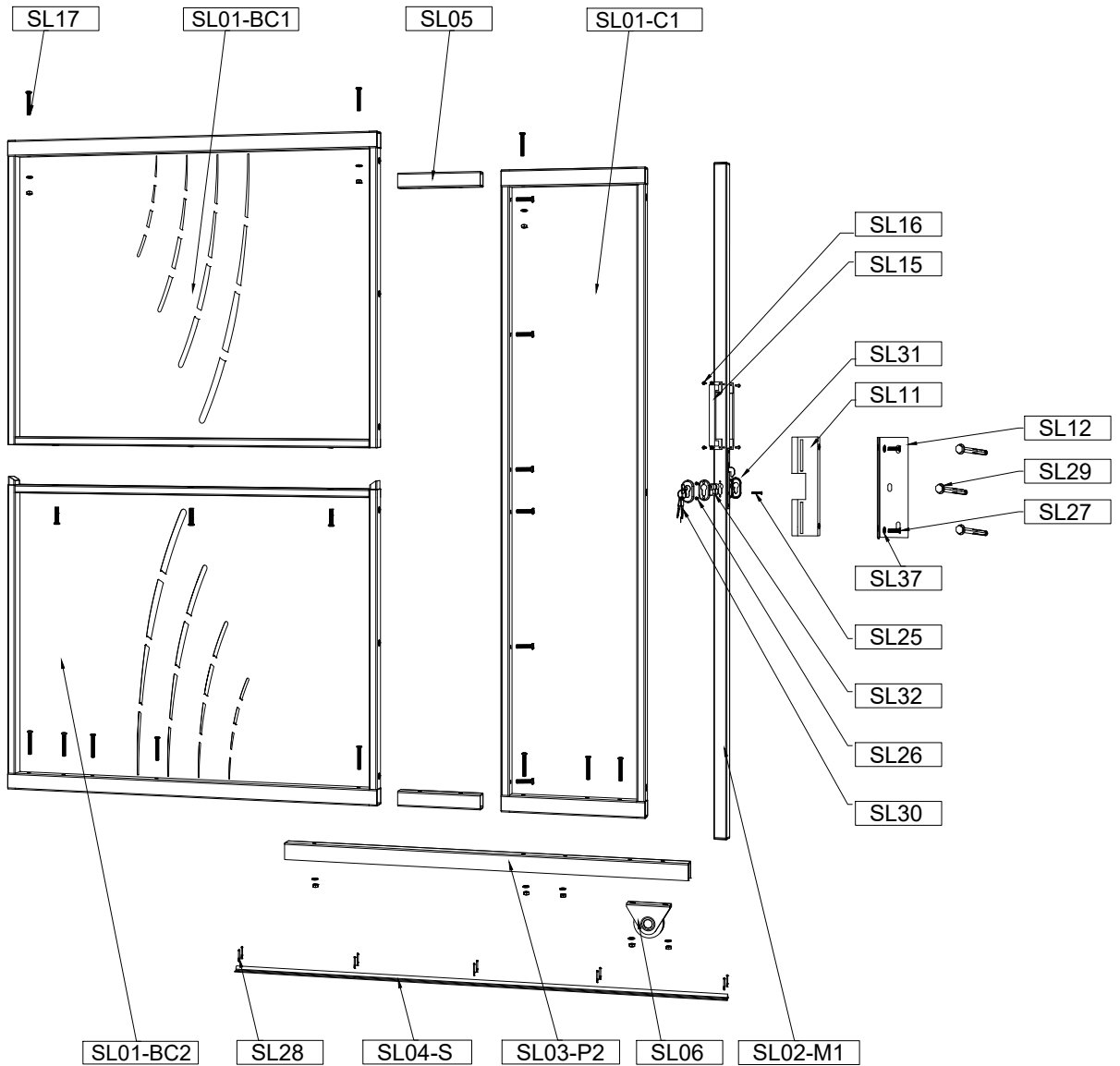



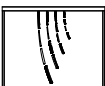

INSTRUCTION MANUAL / NOTICE DE MONTAGE / MONTAGEANLEITUNG / MANUAL DE MONTAJE / MANUAL DE MONTAGEM / MANUALE DI MONTAGGIO /
MONTAGEHANDLEIDING / INSTRUKCJA MONTAŻU / KÄYTTÖOHJEET / BRUKSANVISNING / BRUGSANVISNING / INSTRUCȚIUNI DE ASAMBLARE /
NAVODILA ZA SESTAVLJANJE / NÁVOD NA MONTÁŽ / ÖSSZESZERELÉSI ÚTMUTATÓ / NÁVOD K MONTÁŽI / UPUTE ZA INSTALACIJU /
ΟΔΗΓΙΕΣ ΣΥΝΑΡΜΟΛΟΓΗΣΗΣ / SURINKIMO INSTRUKCIJOS / MONTĀŽAS INSTRUKCIJAS

















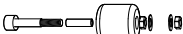

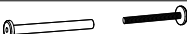











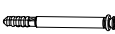

CASANOVA





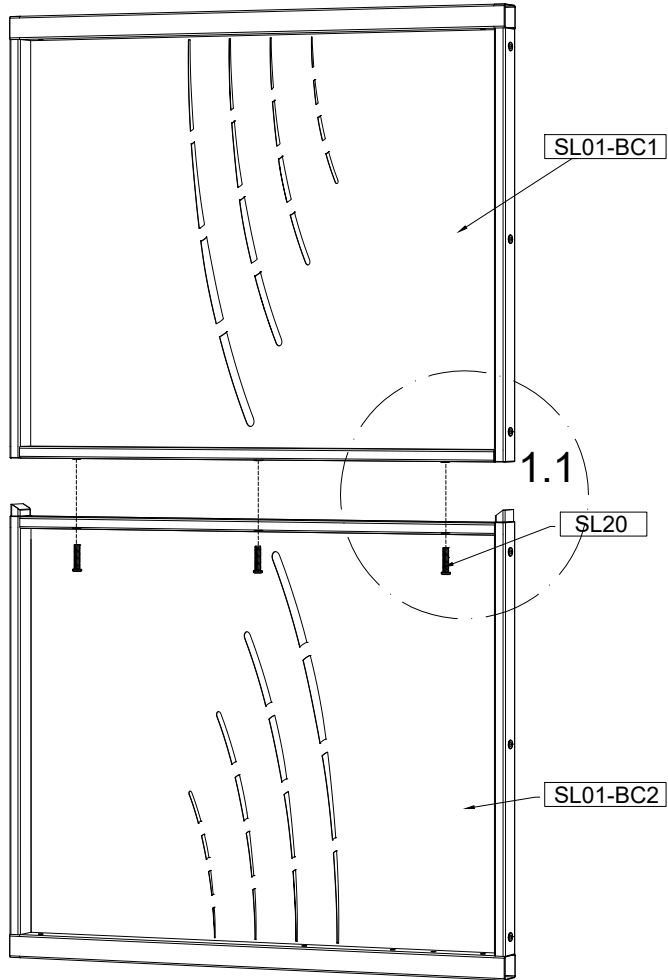

	REF-PCS	DIM	
	SL01-BC1	944.5×762mm	1
	SL01-BC2	944.5×762mm	1
	SL01-BC3	944.5×762mm	1
	SL01-BC4	944.5×762mm	1
	SL01-C1	1524×340mm	1
	SL01-C2	1524×340mm	1
	SL01-C3	1524×340mm	1
	SL02-M1	40×40×1564mm	1
	SL02-M2	40×40×1564mm	1
	SL03-P1	40×40×970mm	1
	SL03-P2	40×40×970mm	2
	SL04-S	46×14×1550mm	4
	SL05	36×36×200mm	8
	SL06	100×79×34mm	4

	REF-PCS	DIM	
	SL07	40×40×14mm	2
	SL08	40×60×200mm	2
	SL09	35×55×120mm	2
	SL10	80×100×90mm	1
	SL11	50×50×253mm	1
	SL12	70×105×253mm	1
	SL13	150×90×150mm	1
	SL14	40×40mm	4
	SL15	35×50×200mm	2
	SL16	4×40mm	4
	SL17	8×55mm	26
	SL18	16×1mm	26
	SL19	13×6mm	26
	SL20	8×35mm	36
	SL21	6×75mm	4
	SL22	10×1mm	8
	SL23	10×5mm	8
	SL24	6×20mm	4
	SL25	5×30mm	1
	SL26	4×20mm	4
	SL27	8×18mm	2
	SL28	8×60mm	40
	SL29	10×100mm	10
	SL30	24×59mm	5
	SL31	33×63mm	2
	SL32	17×33×62mm	1
	SL33	30×75mm	1
	SL34	10×35mm	6
	SL35	20×2mm	6
	SL36	13×21mm	6
	SL37	25×1mm	2



	SL01-BC1	944.5×762mm	1
	SL01-BC2	944.5×762mm	1
	SL20	8×35mm	3

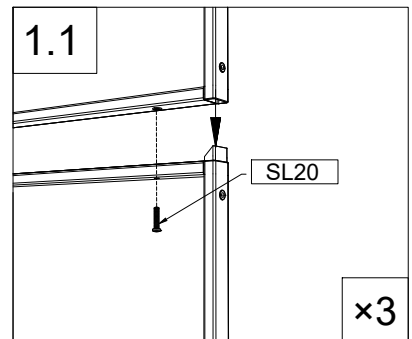

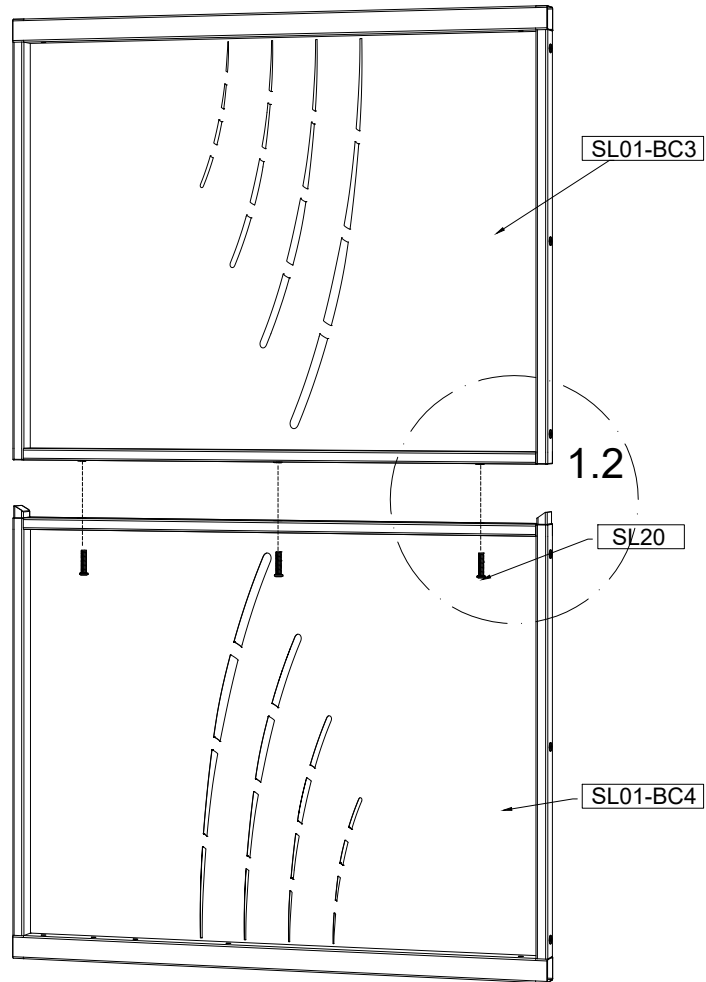



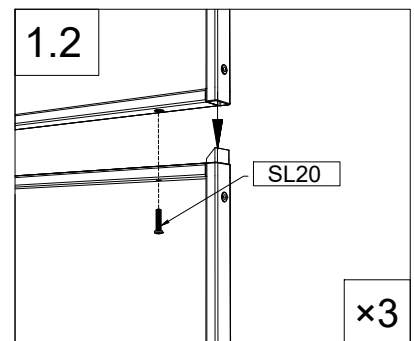



	SL01-BC3	944.5×762mm	1
	SL01-BC4	944.5×762mm	1
	SL20	8×35mm	3





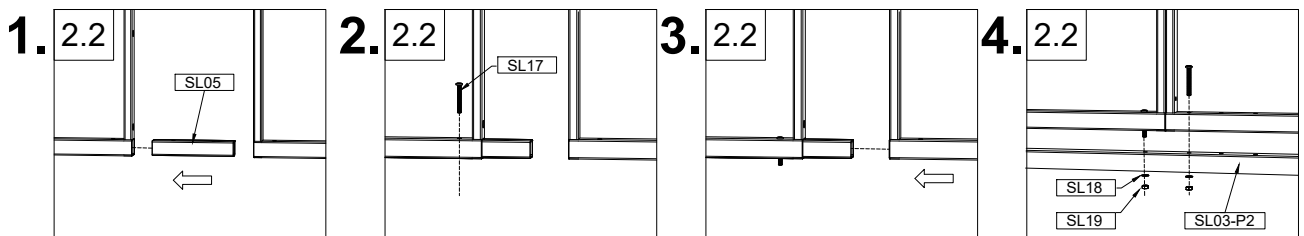
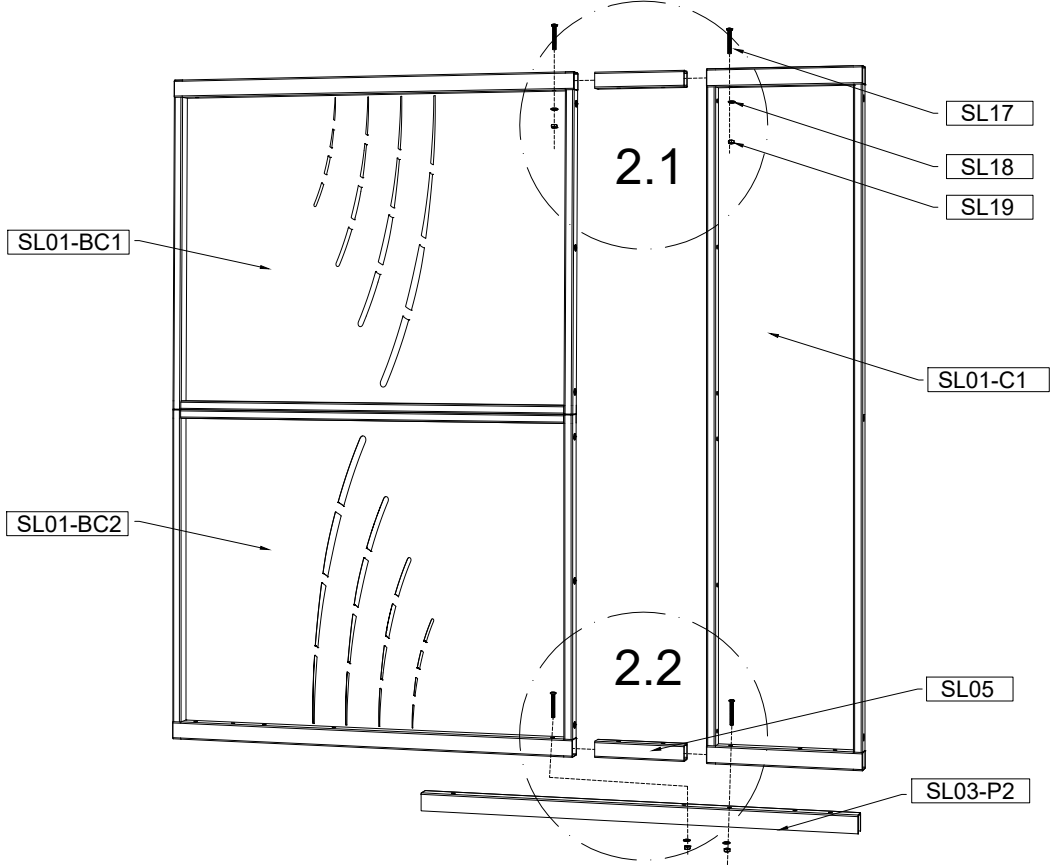
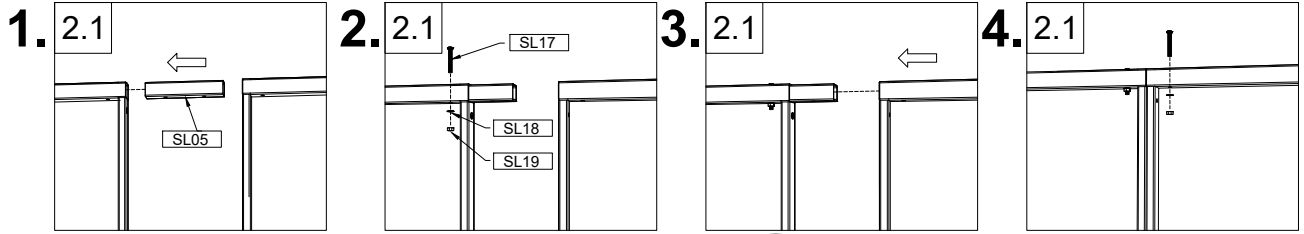

CASANOVA

	SL01-C1	1524×340mm	1
	SL03-P2	40×40×970mm	1
	SL05	36×36×200mm	2



	SL17	8×55mm	4
	SL18	16×1mm	4
	SL19	13×6mm	4



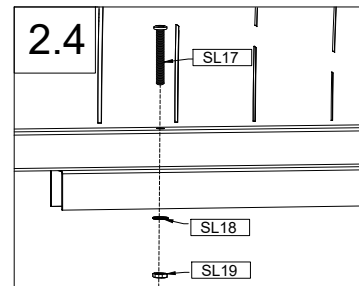
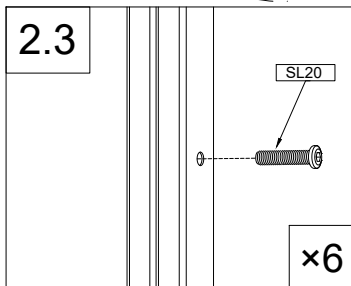
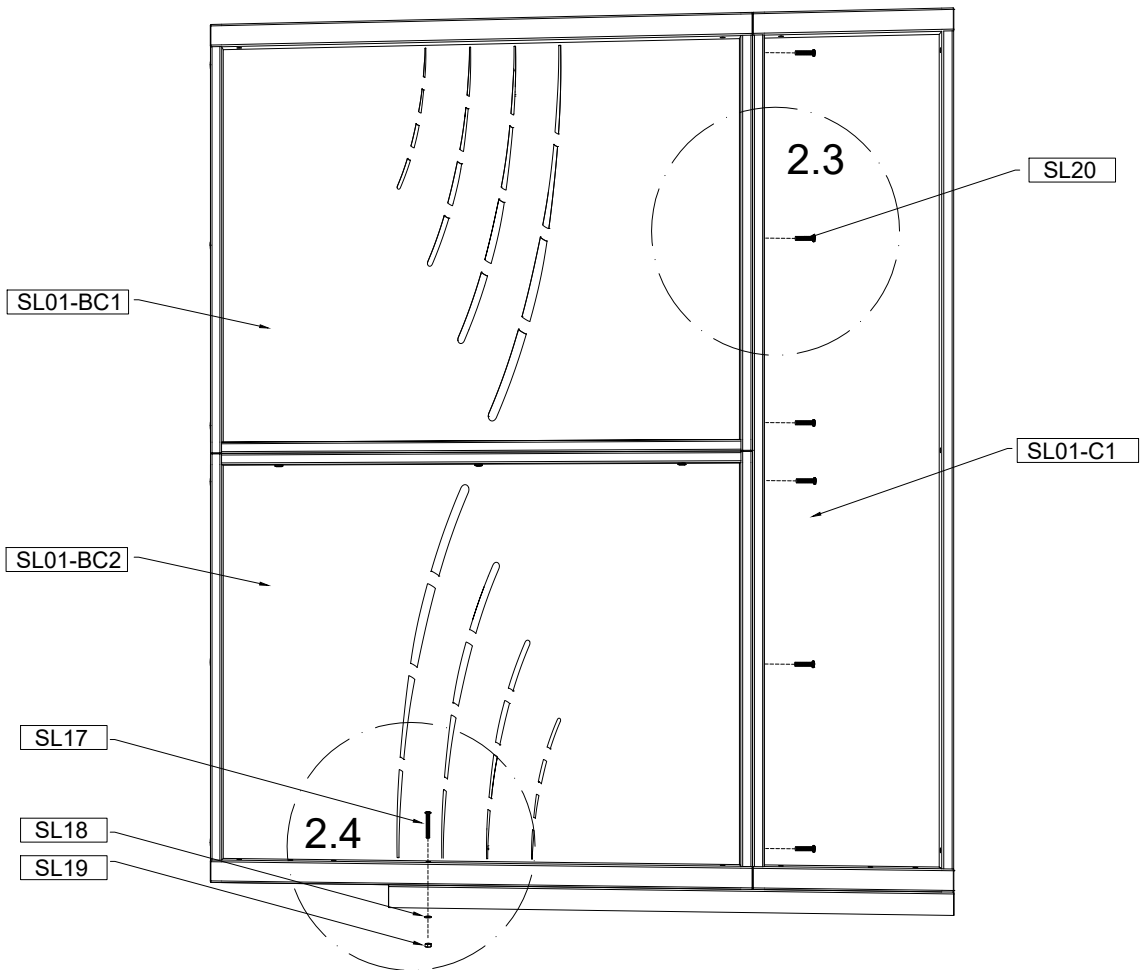

	SL17	8×55mm	1
	SL18	16×1mm	1
	SL19	13×6mm	1
	SL20	8×35mm	6





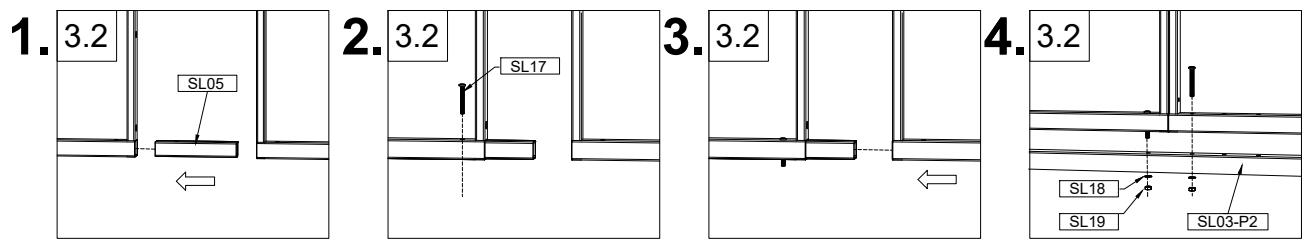
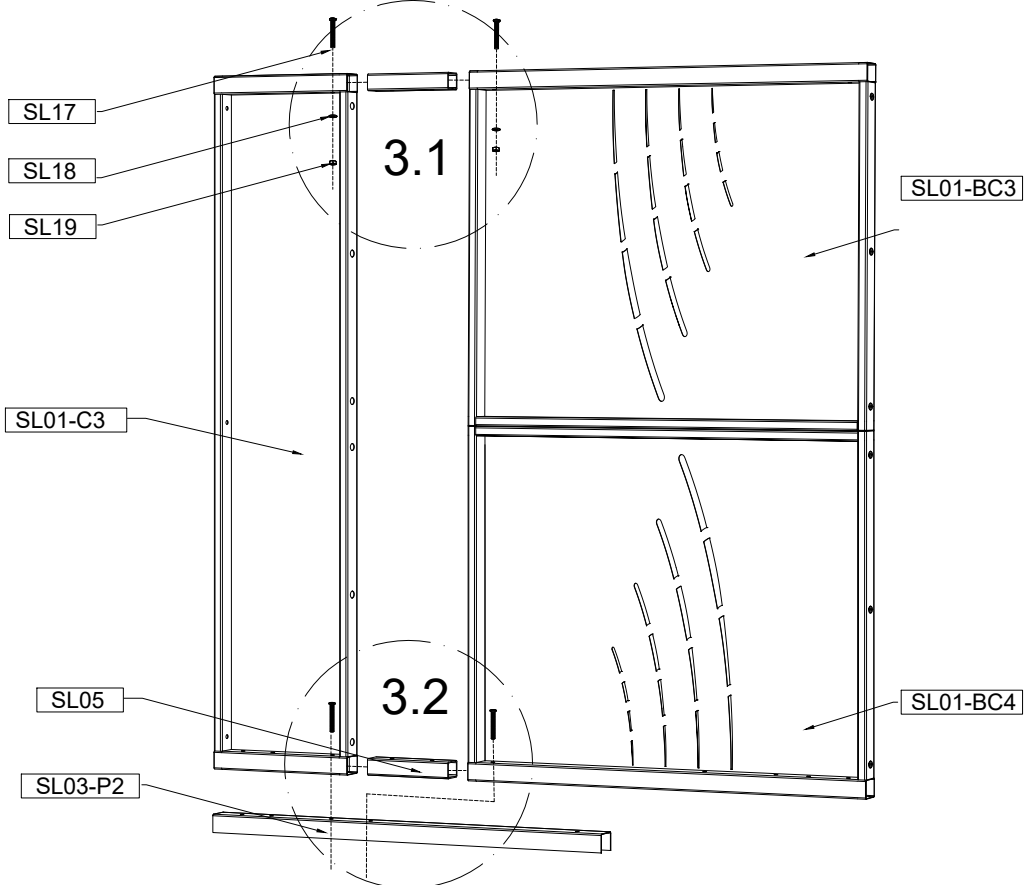
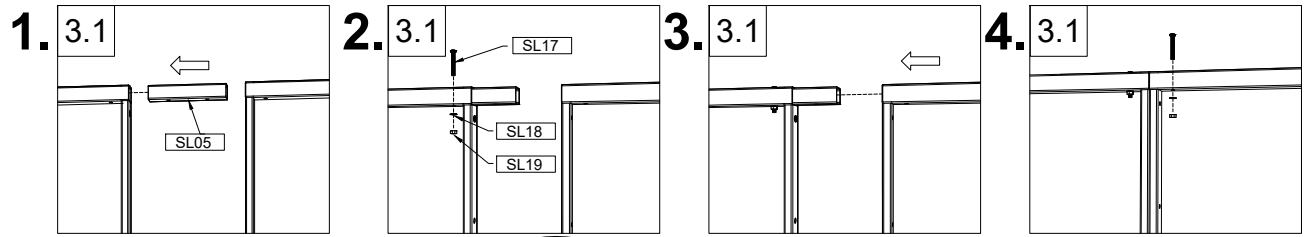

CASANCOV

	SL01-C3	1524×340mm	1
	SL03-P2	40×40×970mm	1
	SL05	36×36×200mm	2

	SL17	8×55mm	4
	SL18	16×1mm	4
	SL19	13×6mm	4 </td







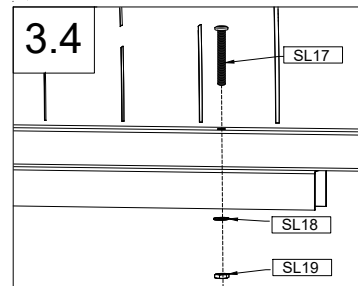
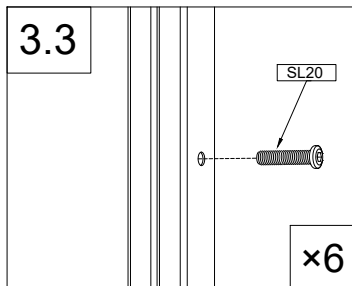
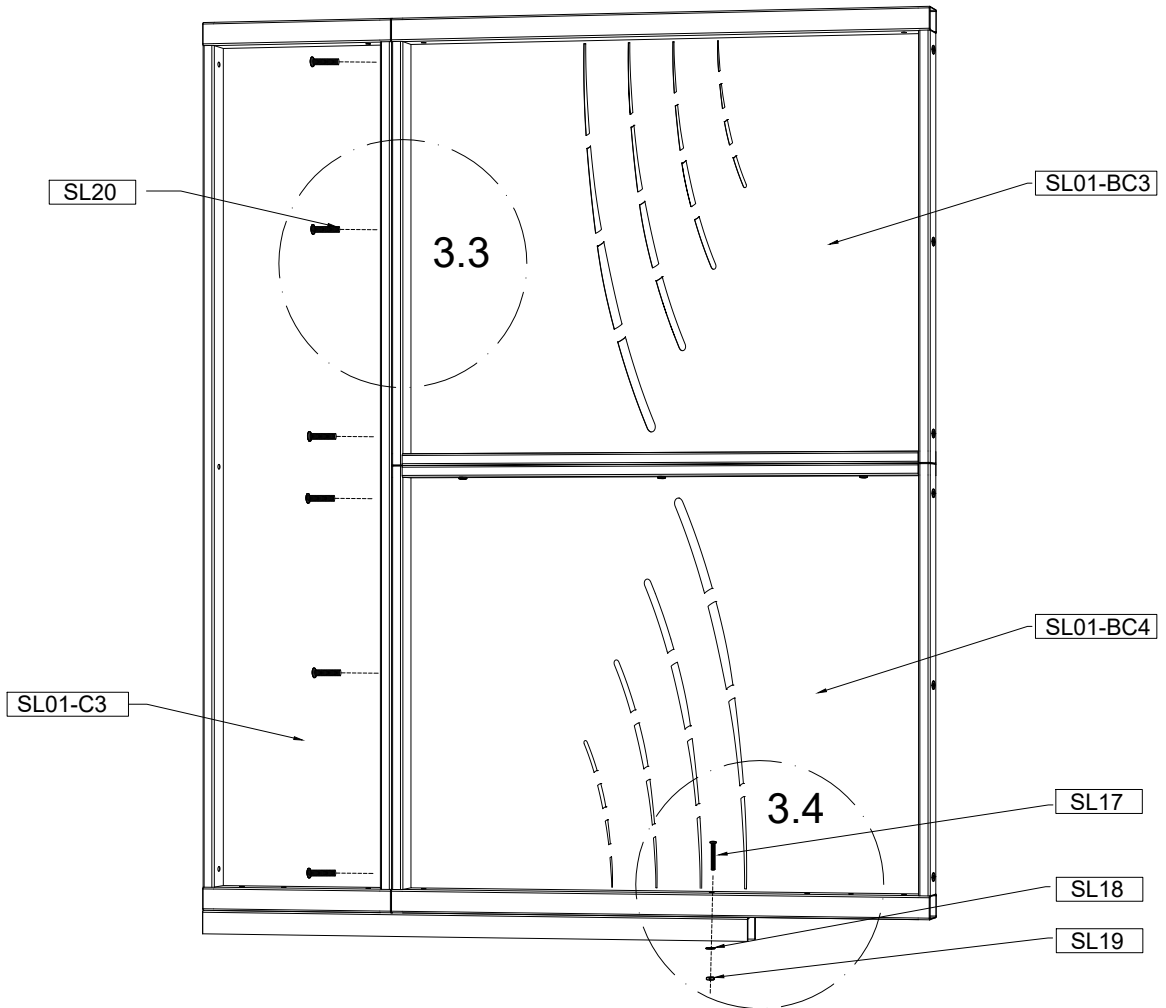

CASANOVA

	SL17	8×55mm	1
	SL18	16×1mm	1
	SL19	13×6mm	1
	SL20	8×35mm	6





CASANOVO

	SL01-C2	1524x340mm	1
	SL03-P1	40x40x970mm	1
	SL05	36x36x200mm	4

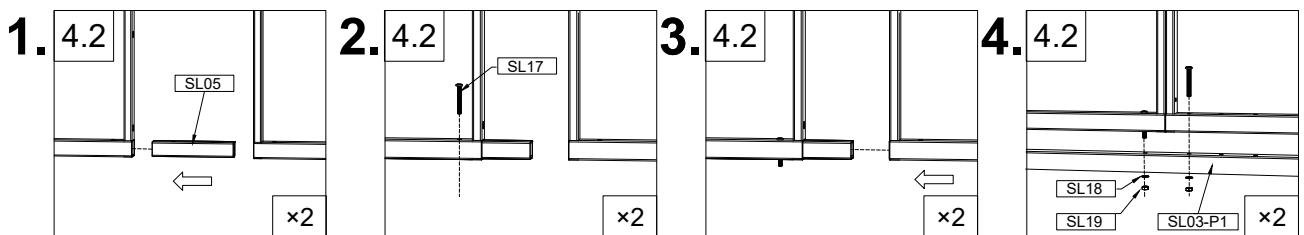
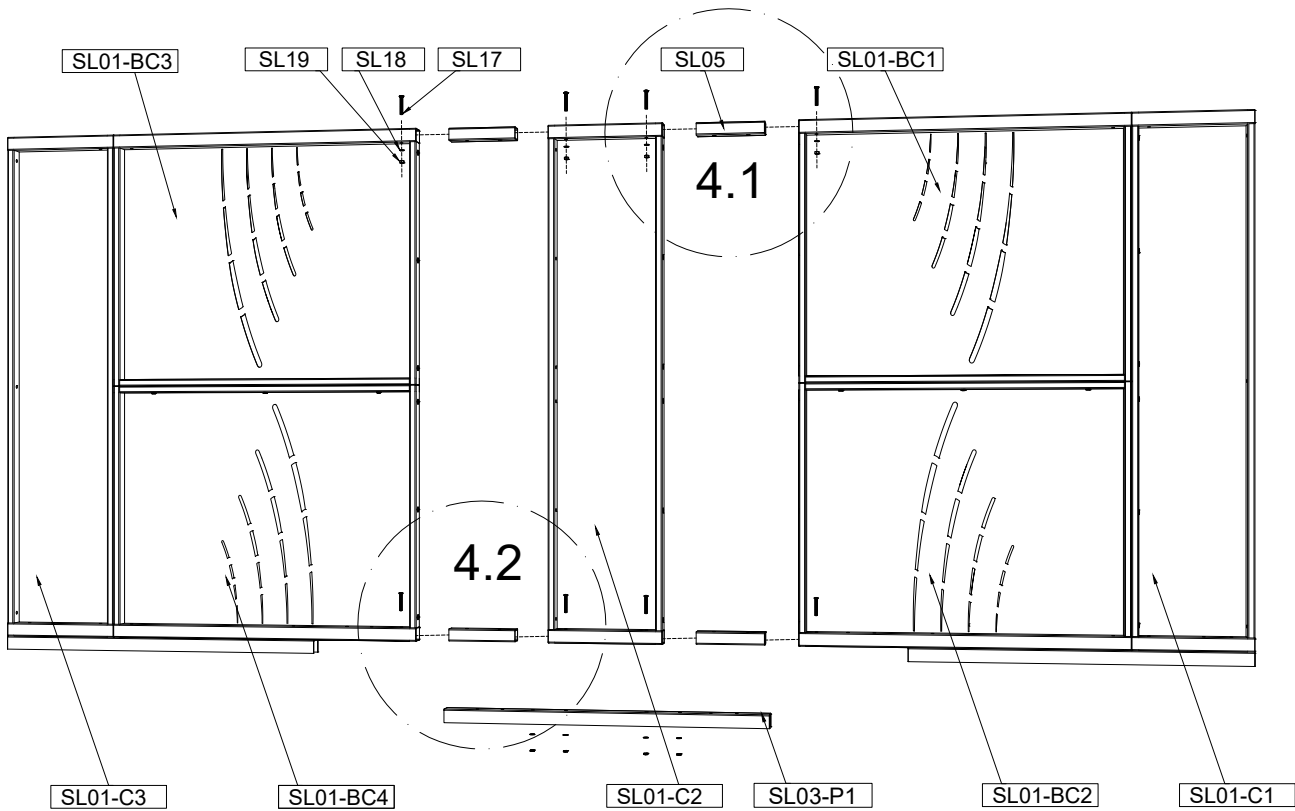
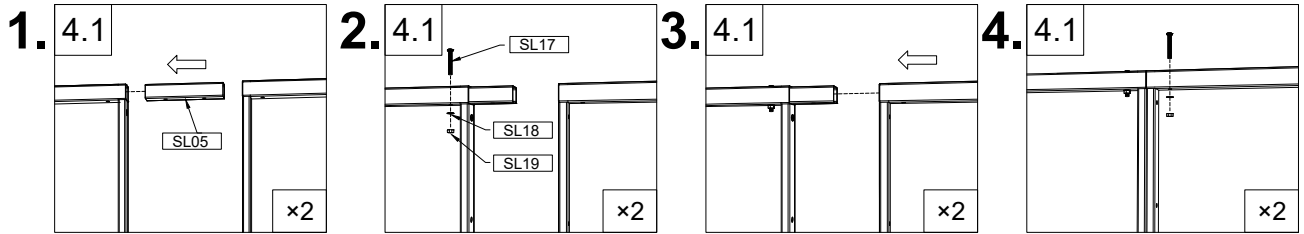
	SL17	8x55mm	8
	SL18	16x1mm	8
	SL19	13x6mm	8

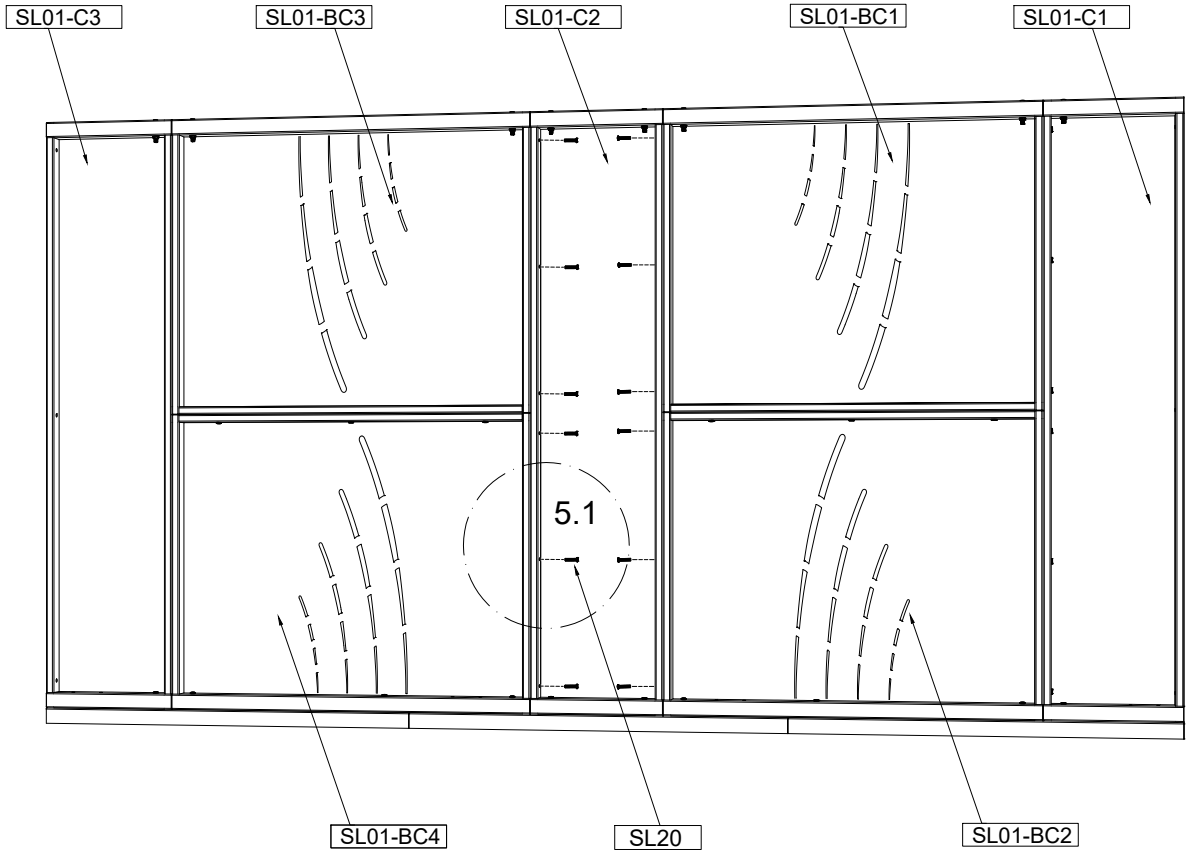





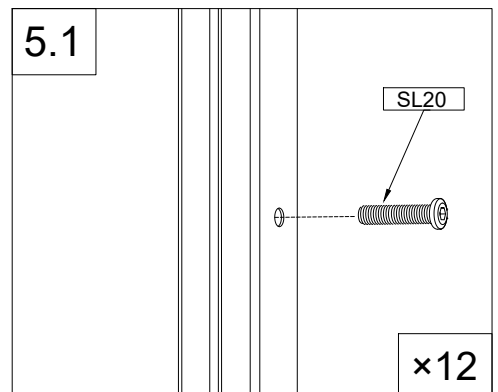

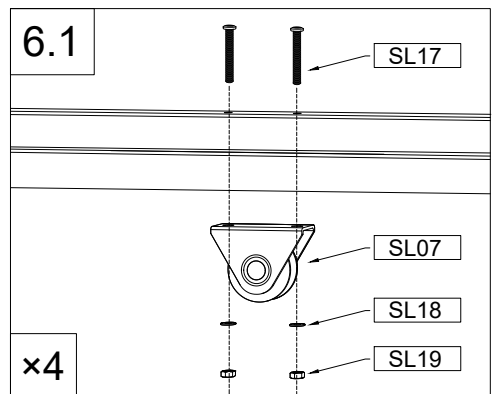
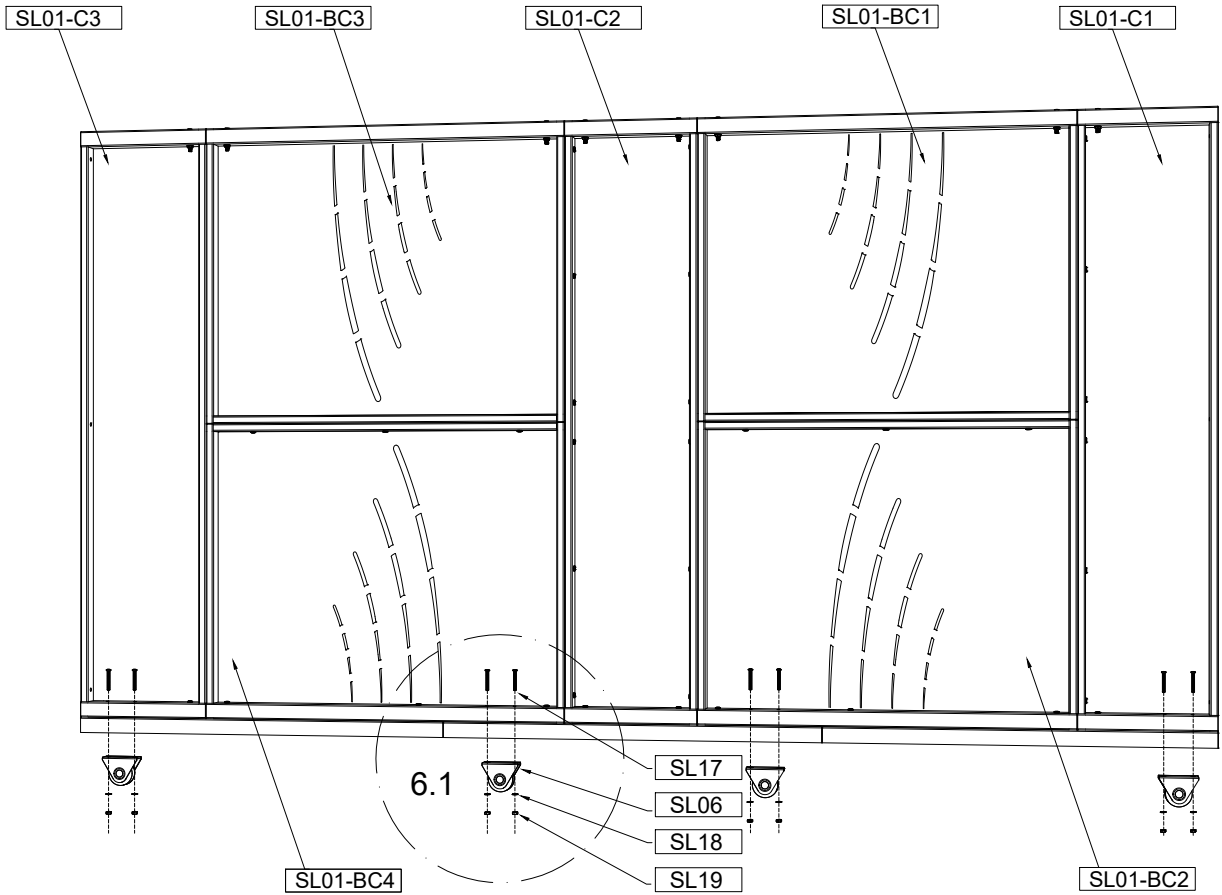

	SL20	8×35mm	12
---	------	--------	----





	SL06	100×79×34mm	4
	SL17	8×55mm	8
	SL18	16×1mm	8
	SL19	13×6mm	8



CASANOVO

	SL02-M1	40×40×1564mm	1
	SL02-M2	40×40×1564mm	1

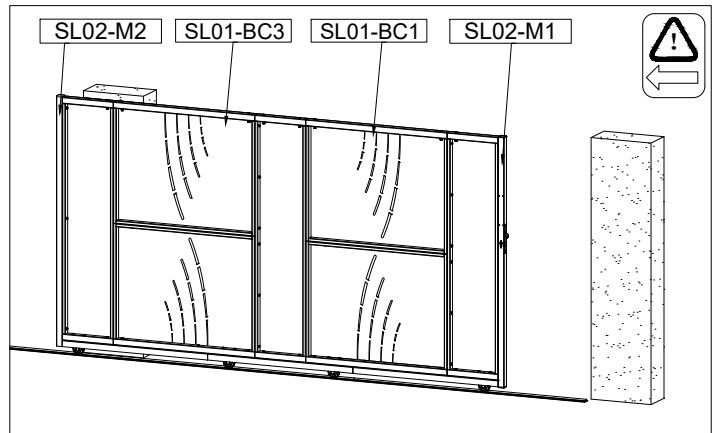
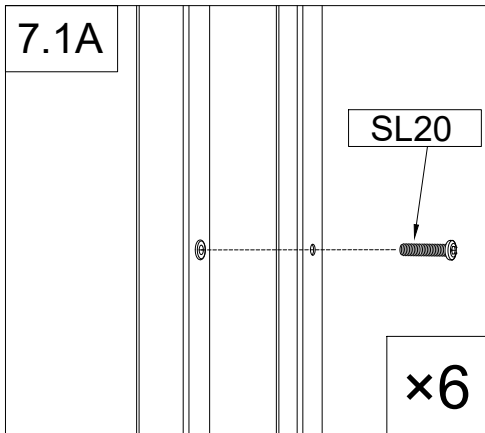
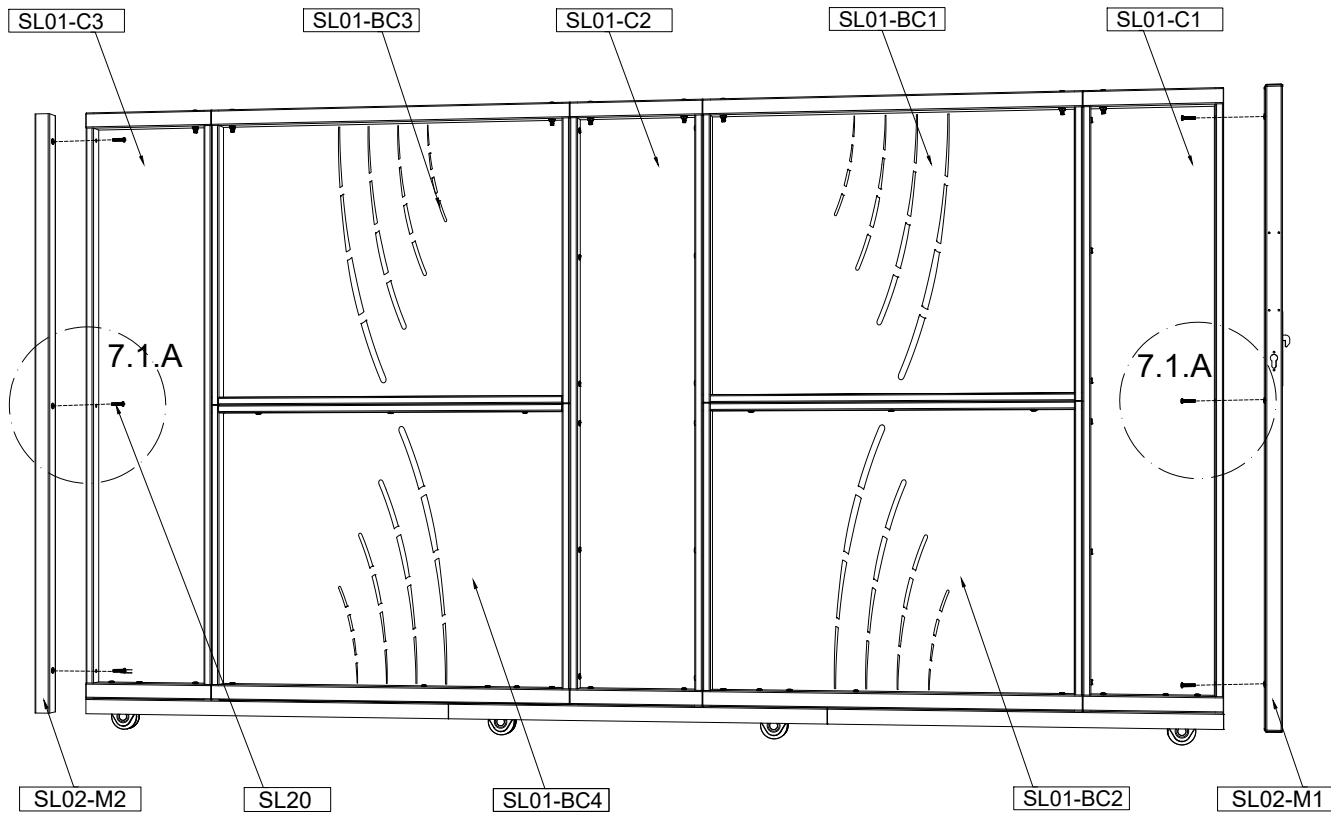
	SL20	8×35mm	6
---	------	--------	---





CASANOVO

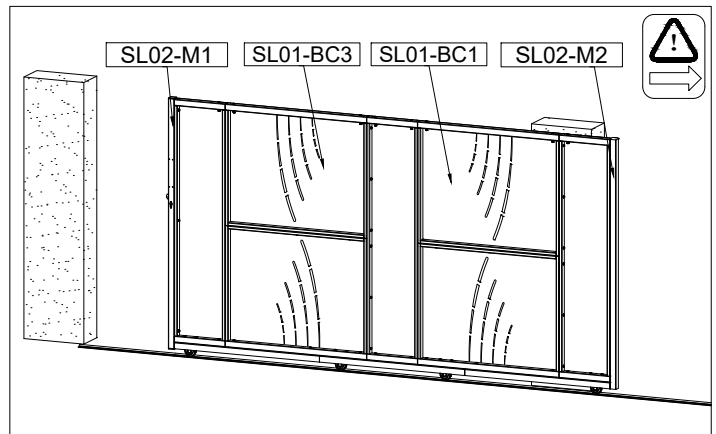
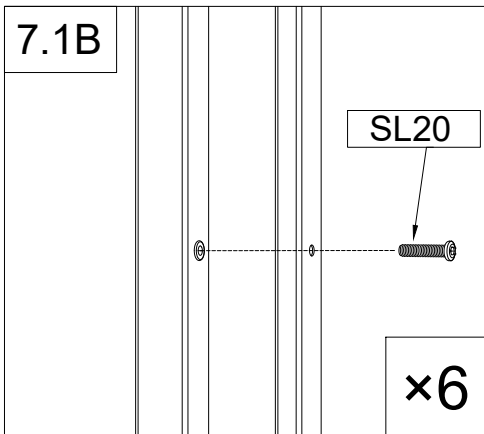
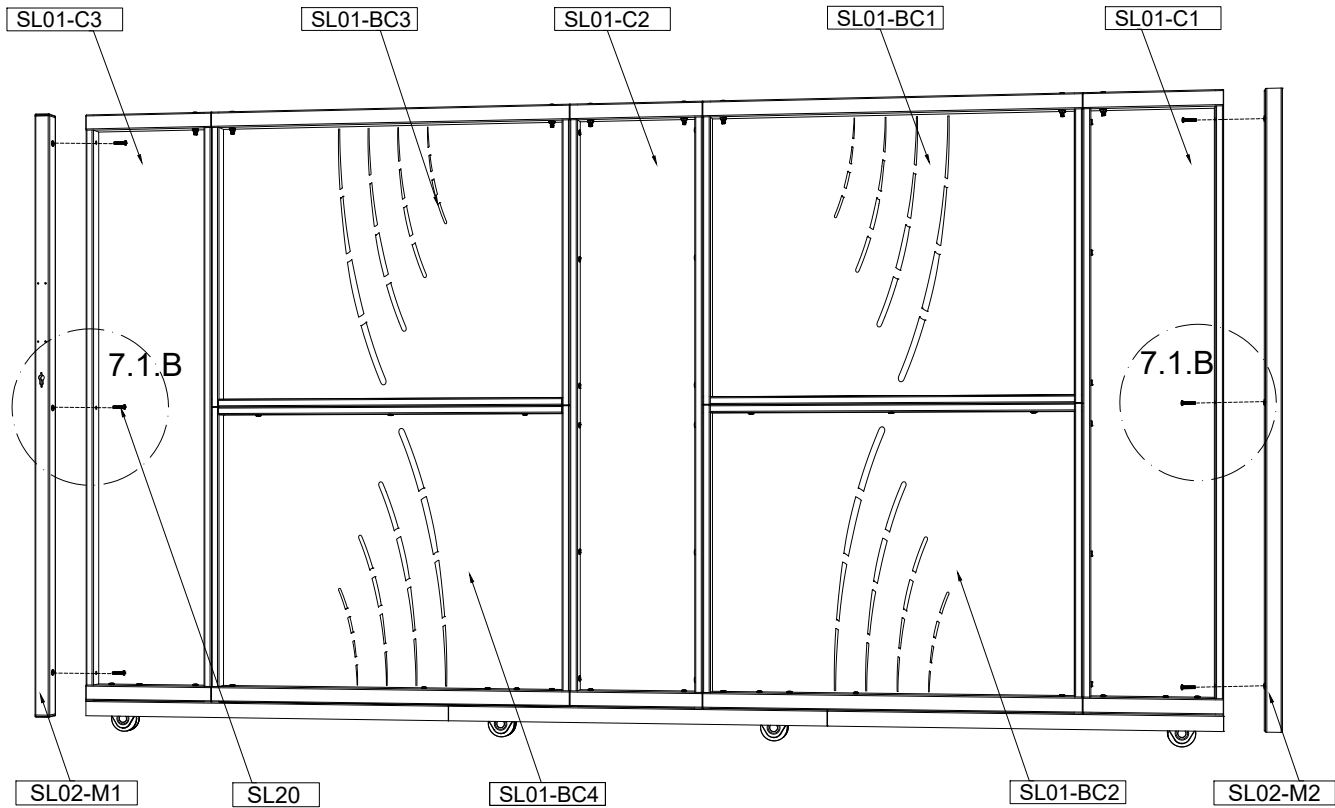

	SL02-M1	40×40×1564mm	1
	SL02-M2	40×40×1564mm	1

	SL20	8×35mm	6
---	------	--------	---





CASANOVA

	SL25	5×30mm	1
	SL26	4×20mm	4
	SL30	24×59mm	5

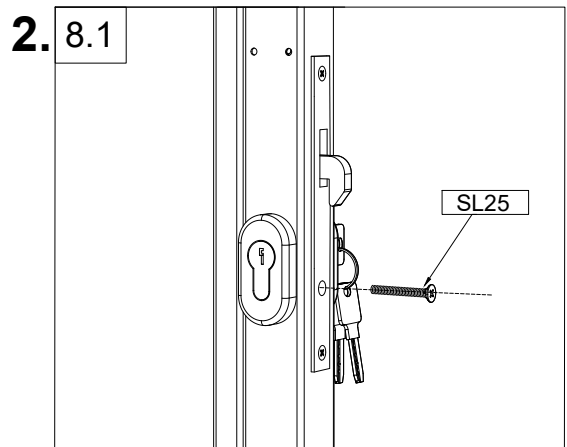
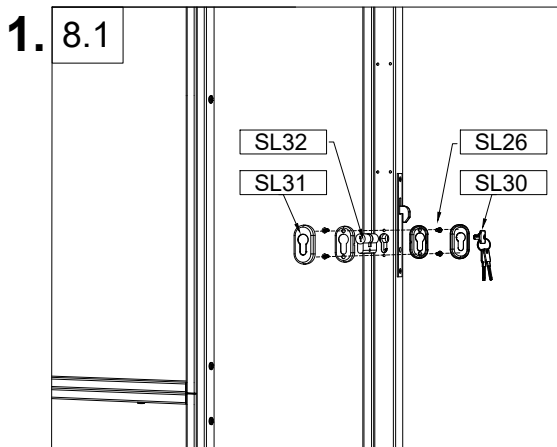
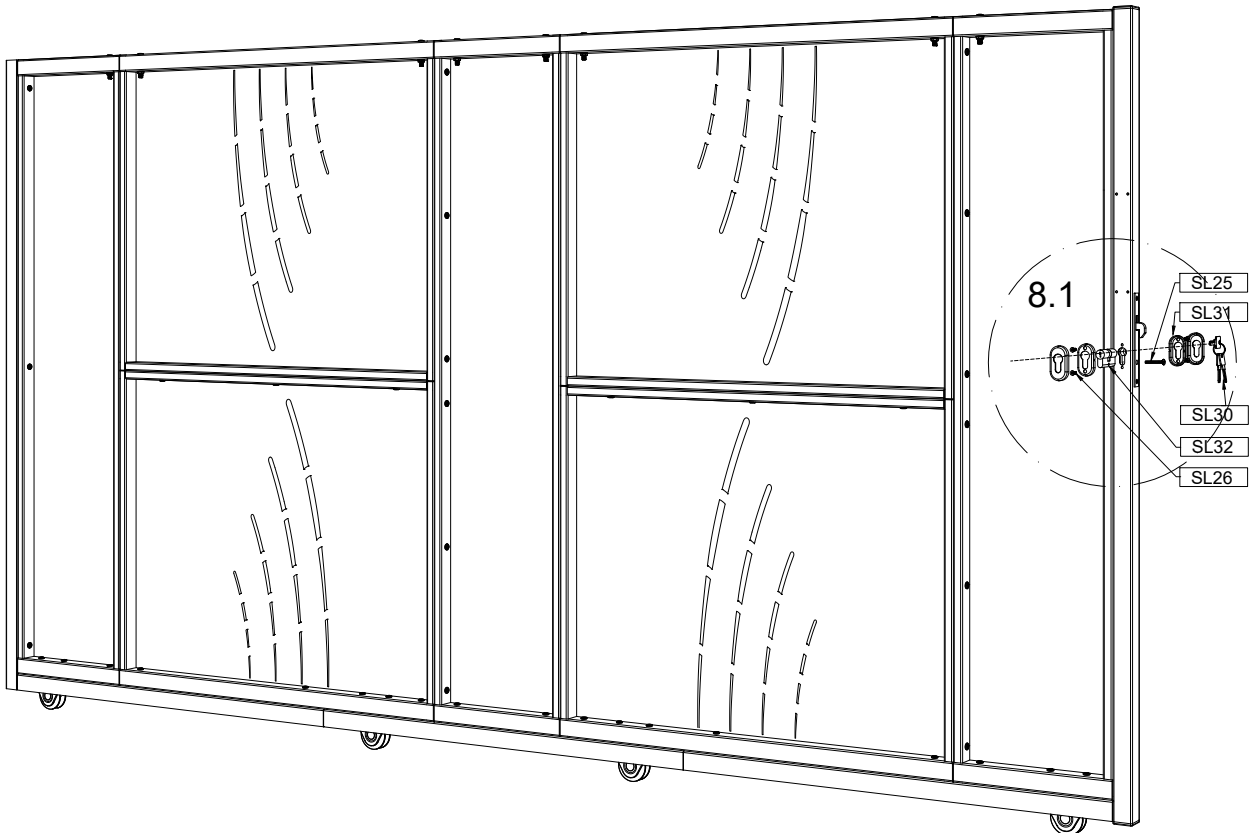
	SL31	33×63mm	2
	SL32	17×33×62mm	1

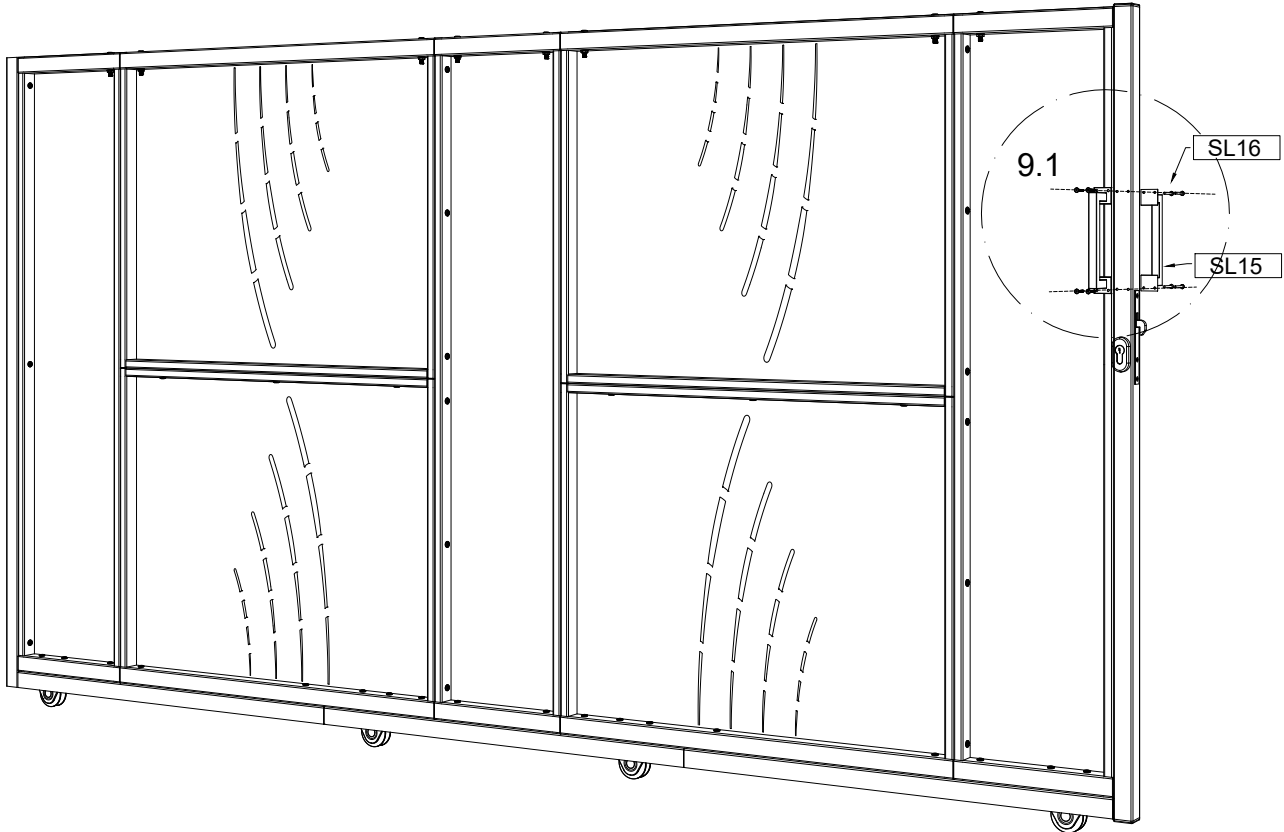



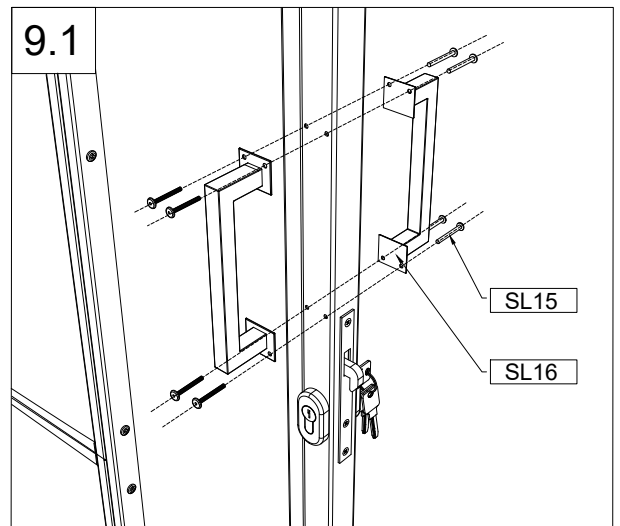

	SL15	35×50×200mm	2
	SL16	4×40mm	4

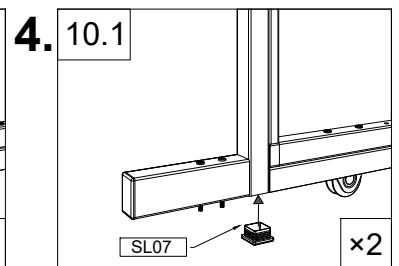
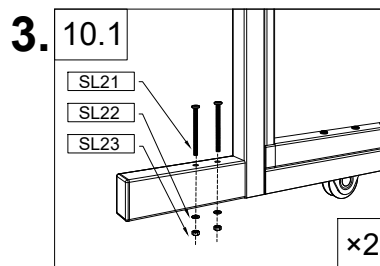
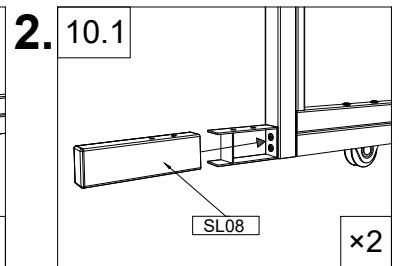
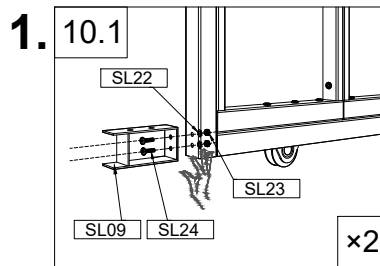
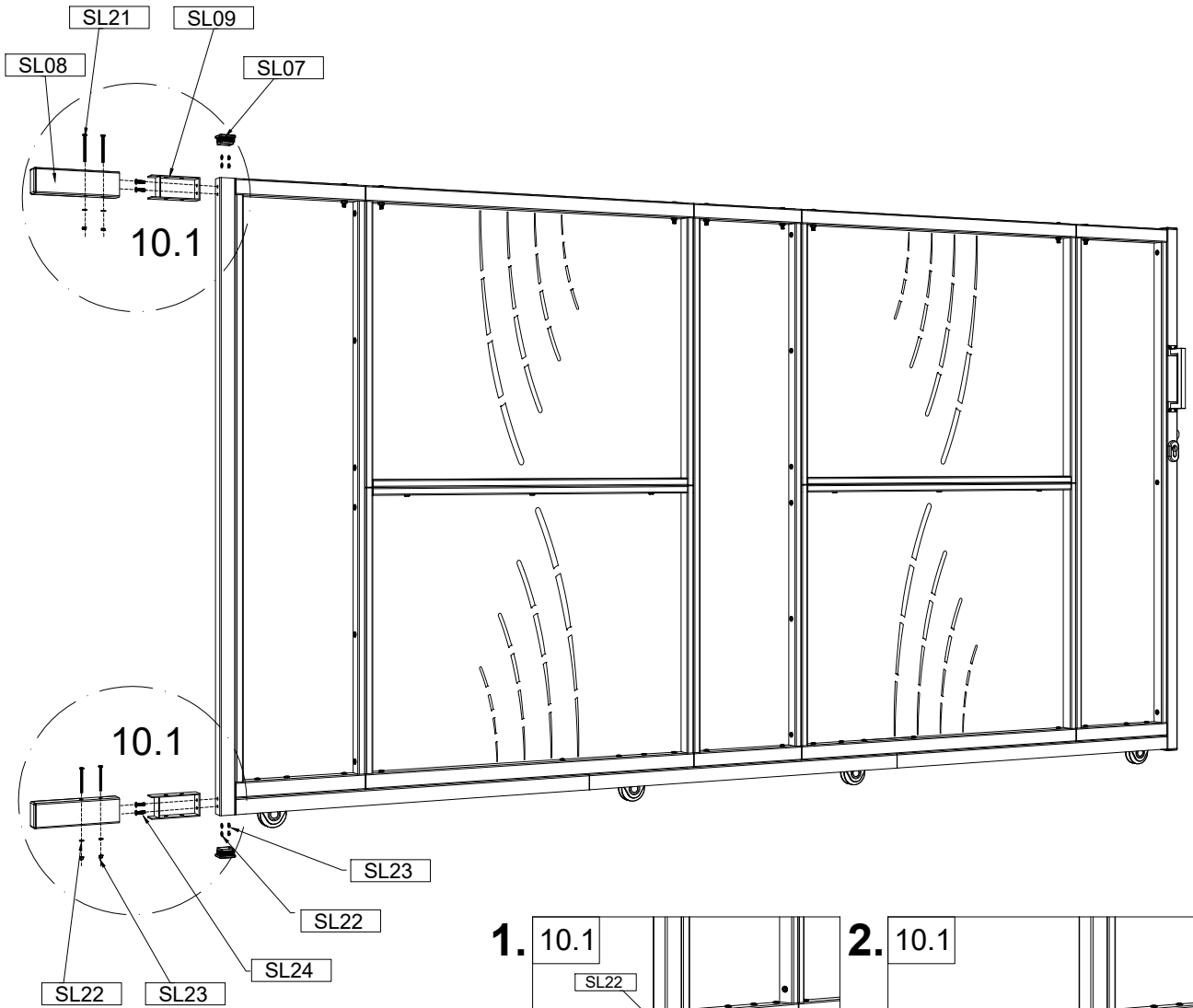



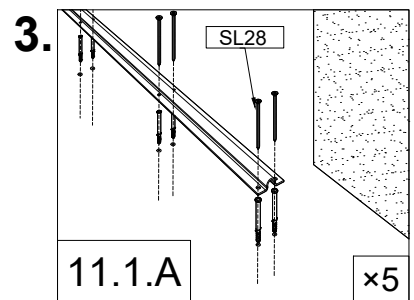
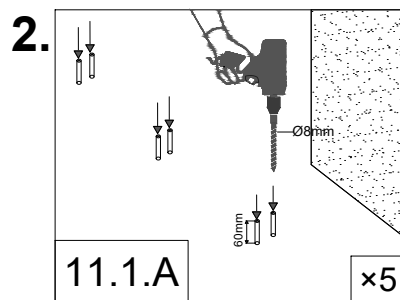
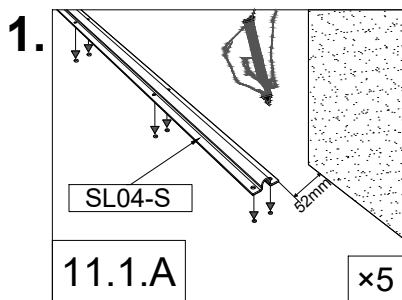
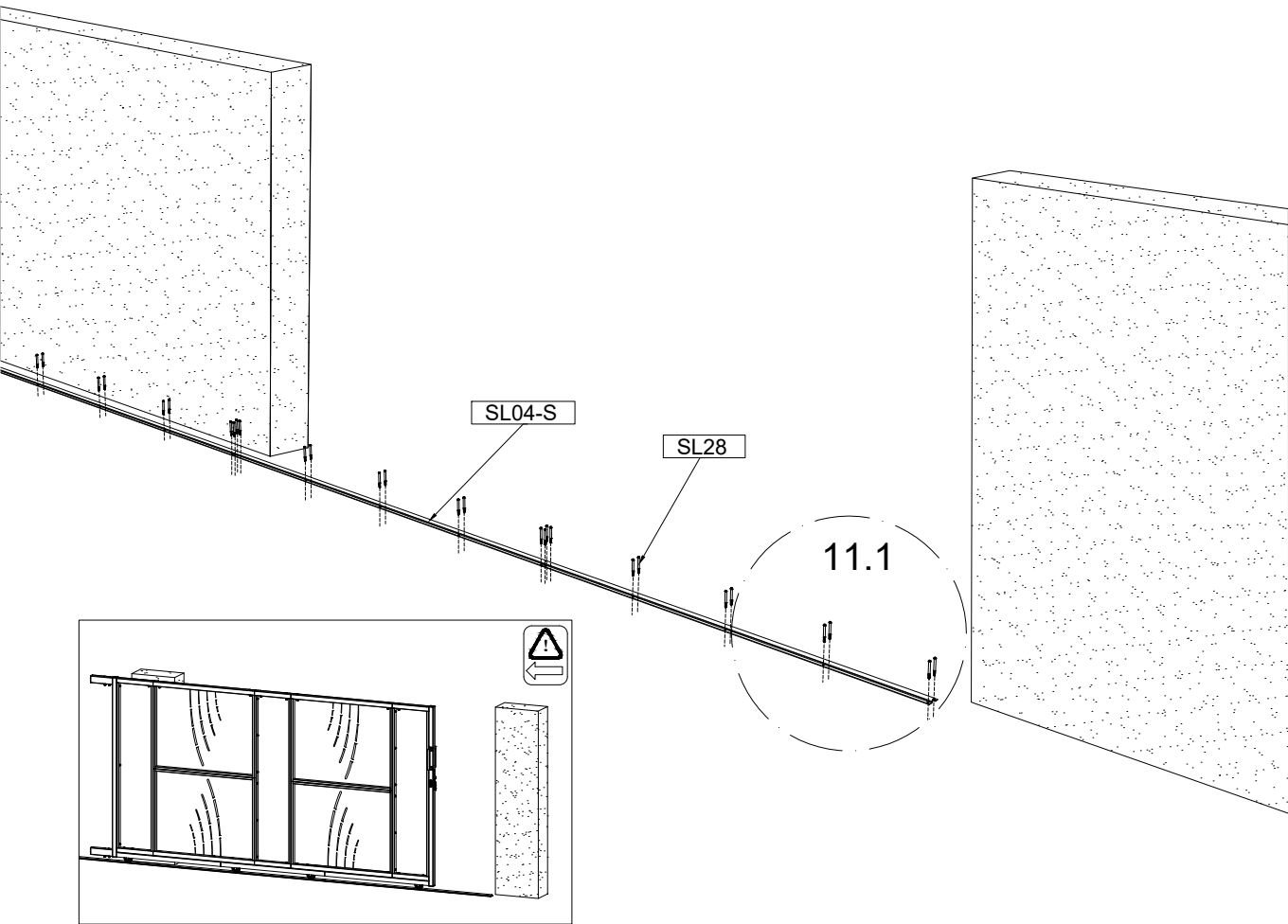

	SL07	40×40×14mm	2
	SL08	40×60×200mm	2
	SL09	35×55×120mm	2
	SL21	6×75mm	4
	SL22	10×1mm	8
	SL23	10×5mm	8
	SL24	6×20mm	4

	SL04-S	46×14×1550mm	4
	SL28	8×60mm	40



	SL04-S	46×14×1550mm	4
	SL28	8×60mm	40

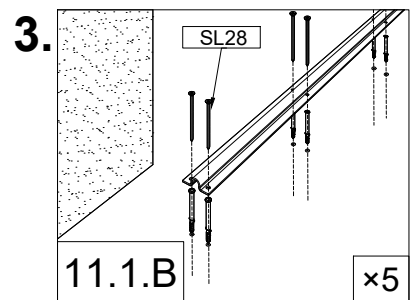
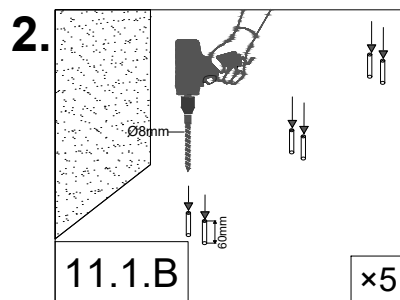
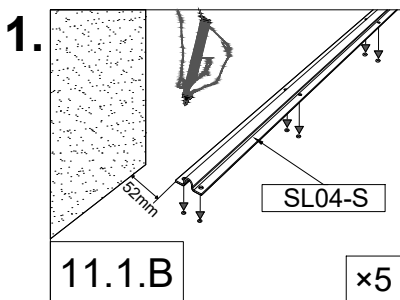
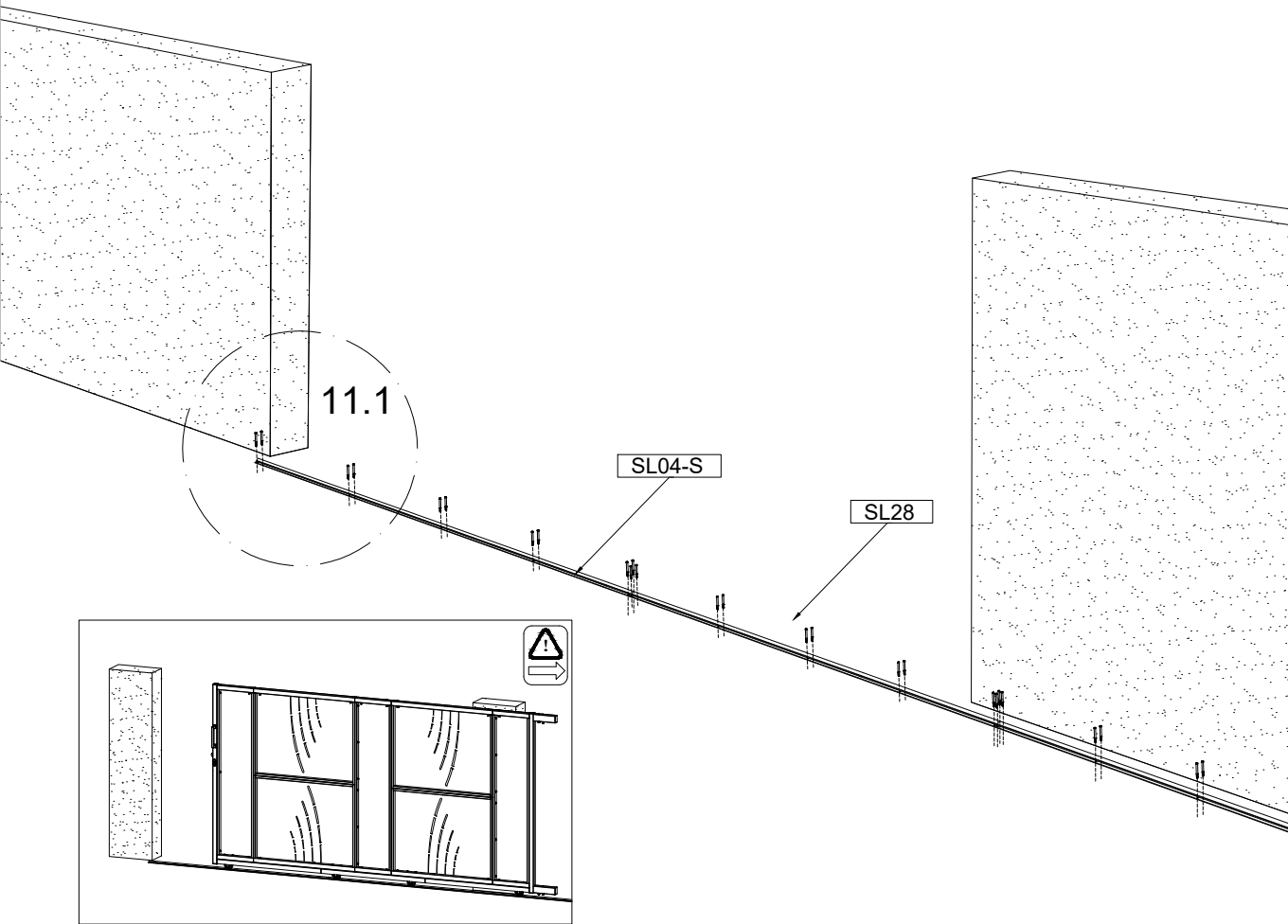



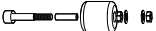
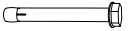

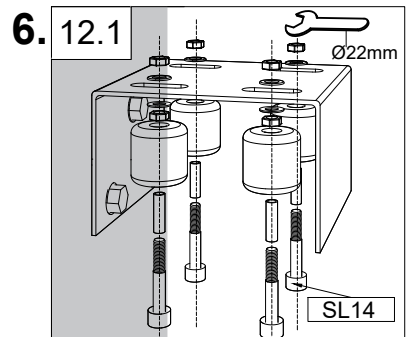
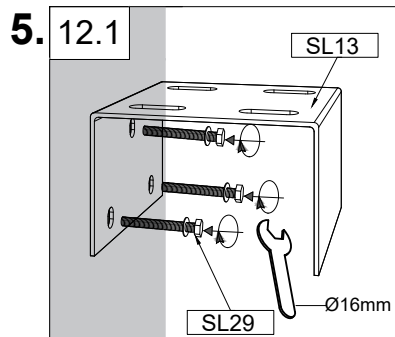
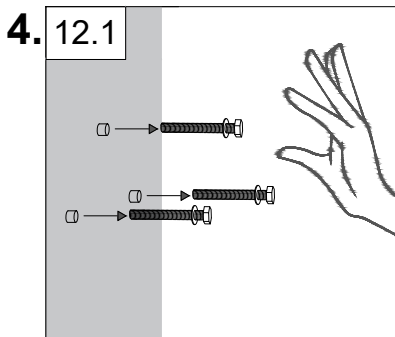
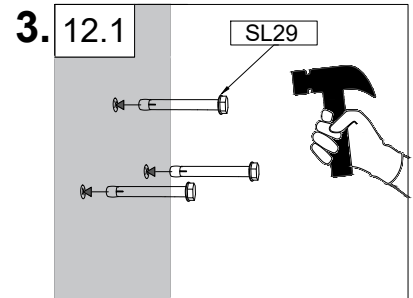
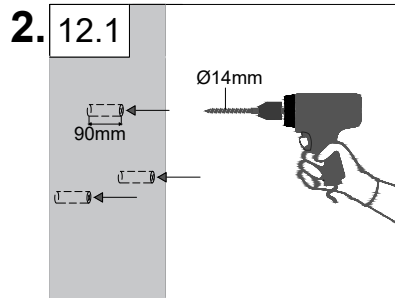
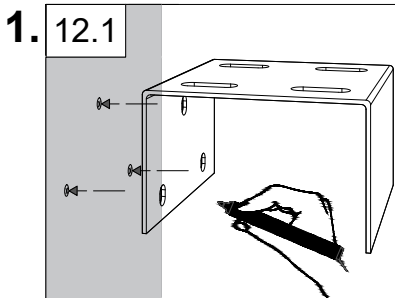
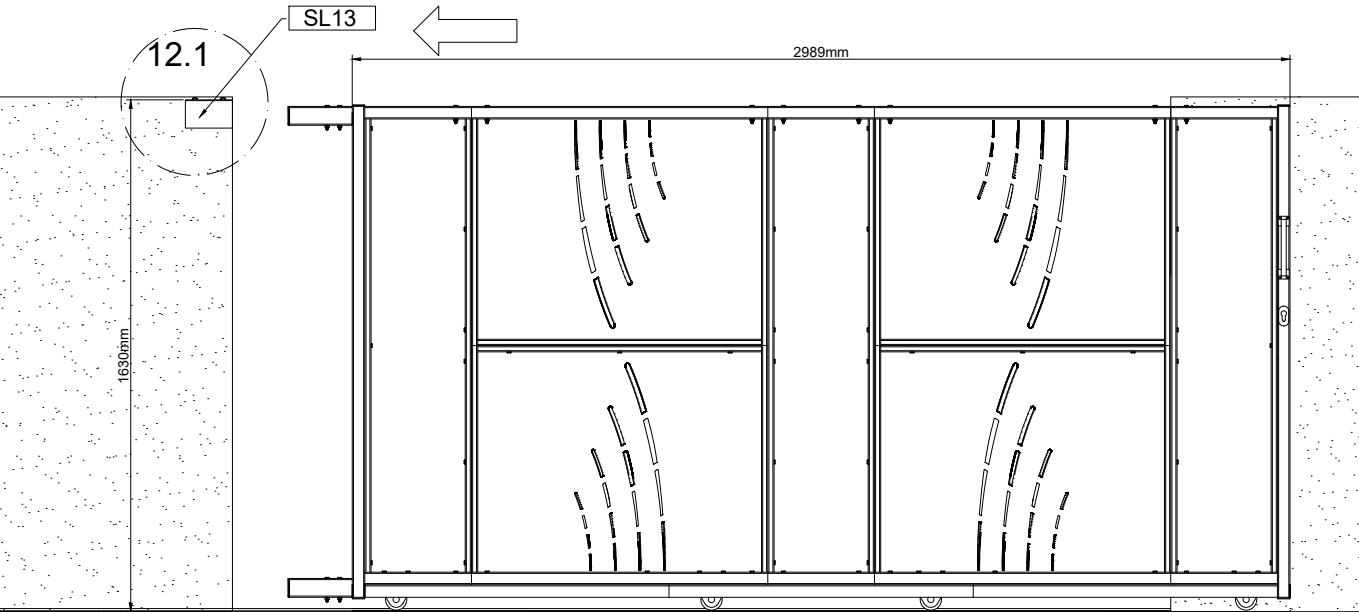
CASANOVO

	SL13	150×90×150mm	1
	SL14	40×40mm	4
	SL29	10×100mm	3



CASANOVO

	SL11	50×50×253mm	1
	SL12	70×105×253mm	1
	SL37	25×1mm	2
	SL27	8×18mm	2
	SL29	10×100mm	3

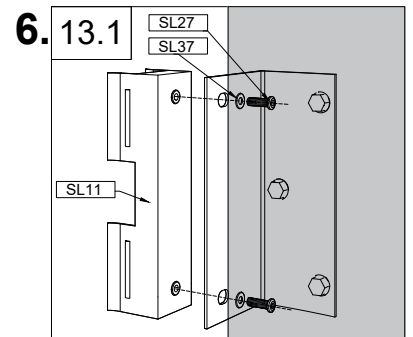
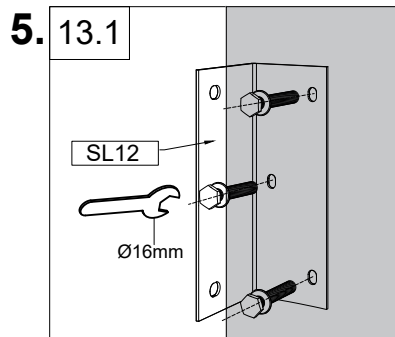
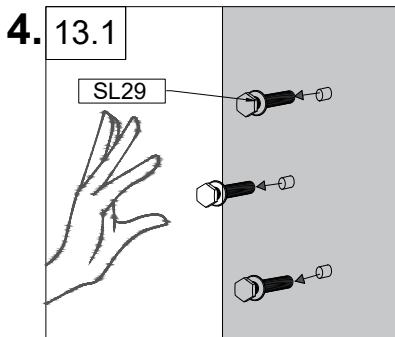
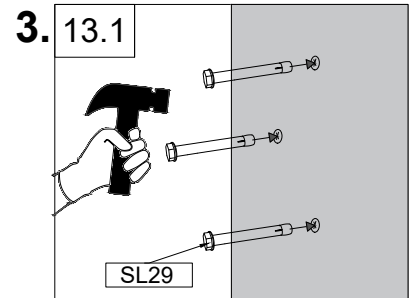
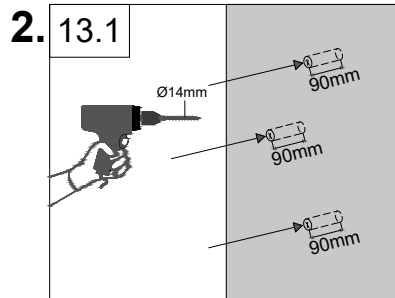
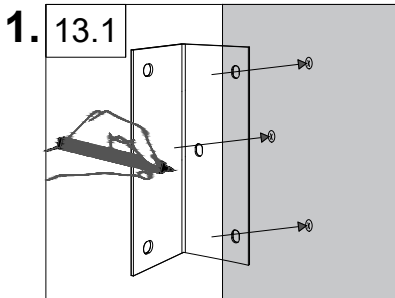
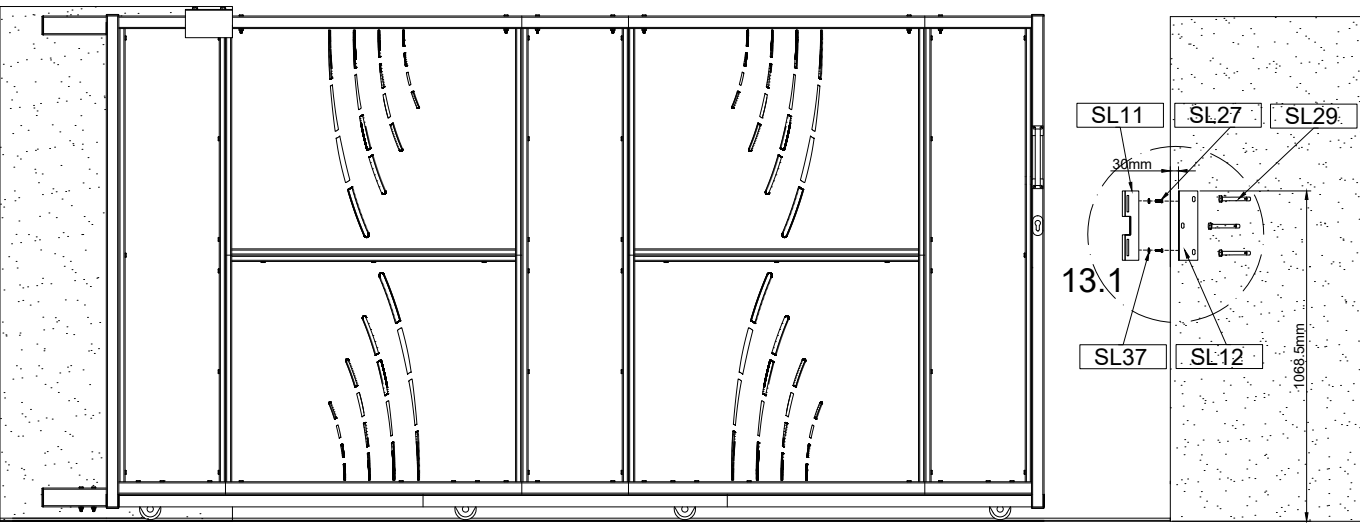

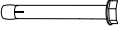
	SL10	80×100×90mm	1
	SL29	10×100mm	4

